

SAFETY IN MINES RESEARCH ADVISORY COMMITTEE

Final Report

Summary Report on Underground Road Header Environmental Control

B K Belle, F J van Zyl and J J L Du Plessis

Research agency : CSIR Miningtek (SA) and IMCL (UK)
Report number : ESH 00-0206
Project number : COL 603
Date : January 2002

Executive Summary

The primary objective of the Road Header (RH) Environmental Control project (COL 603) is to minimise the dust exposure of workers while maintaining adequate ventilation conditions in RH headings in order to optimise the working environment of mine workers. This report describes the work done during the third phase of the overall project, involving underground trials on the full range of control systems carried out by the CSIR Miningtek team in the South Shaft of Bank Colliery.

The constantly high dust levels at the RH operator's position prompted the Department of Minerals and Energy (DME) to issue a directive enforcing a maximum dust-concentration level of 5 mg/m^3 at the RH operator's position. The main objective of this project was to find ways of controlling the environment to ensure that dust and methane levels are kept within the regulatory requirements.

The project was conducted in three phases. During the first phase, an extensive literature review of past international and South African research on best ventilation and dust-control practices was carried out by IMCL (UK) and CSIR Miningtek (South Africa). In the second phase of the project, studies were carried out in a surface gallery at IMCL, UK. From this work, recommendations were made on the most effective way to control dust and methane in an RH heading. The third phase of the project consisted of evaluating the ventilation and dust-control systems (as proposed from the surface work) underground. Two systems were evaluated:

- System 1: Bank 2000 Road Header Dust Control System without a wet head.
- System 2: Bank 2000 Road Header Spray System with a wet head.

The results obtained during the trials of the systems at Bank Colliery, South Shaft, were encouraging for both the dust-control systems, with all the individual elements operational, constantly keeping the dust-concentration levels below the 5 mg/m^3 design criterion. The average dust-concentration levels at the RH operator's position for the two systems tested are shown below:

System	Number of Tests	Sampling Period Average in mg/m³	TWA-CONC (8-h) in mg/m³
1	17	4,88	3,82
2	8	3,75	2,69

For the scenarios tested at Bank Colliery, South Shaft, Section 13, the following observations were made:

- The Bank 2000 Road Header Dust Control System (DCS) is able to maintain dust-concentration levels below 5 mg/m³ at the operator's position.
- The DCS was able to keep the methane concentrations below the permissible limit of 1,4% CH₄ by volume. (The tests did not evaluate the system's performance in high-methane-content seams in ensuring methane dilution and ventilation effectiveness across the face. Therefore, the effect of higher methane contents and emission rates in a heading must be borne in mind).

To achieve these results consistently, the following have been identified as potential factors that can render the DCS ineffective:

- It is extremely important that the DCS's spray configuration and its individual components are properly manufactured, installed (orientated), operated and maintained in order to achieve these results consistently. These factors include spray blocks, sprays, water supply pressure and water flow rate.
- The quality of the spray nozzles must be consistent with the design parameters. From underground observations, the general quality of the spray nozzles appeared to be quite variable, particularly with respect to the final orifice hole that was drilled into the thin sheet-metal plate. Visual inspection of a number of nozzles revealed a range of defects, including angled drilling of the holes, elliptical orifices and the presence of burrs. These defects cause problems such as incorrectly aligned sprays, gaps in spray coverage and a generally 'streaky' appearance to the spray.
- An air velocity of at least 1 m/s must be maintained in the last through road (LTR) to maximise the entrainment of fresh air into the heading.
- Section personnel must be trained with regard to the function and concept of each component of the DCS for correct operation and maintenance.

Based on the tests conducted at Bank Colliery, South Shaft, the following recommendations are made for potential further improvement of the DCS and associated future research:

1. Several additional changes could be made to the current system which may enhance the environmental conditions in the RH sections, viz.
 - a. Addition of a spray block on the top of the concave spade plate
 - b. Use of concave spade plates on both sides of the RH
 - c. Use of a twin-inlet scrubber with inlets located on the left-hand side (LHS) and right-hand side (RHS) of the RH
 - d. Use of a small fan on the LHS of the operator's position to blow the dust towards the face.
2. It is of critical importance to evaluate the system's performance in high-methane-content seams to ensure effective methane dilution and ventilation effectiveness across the face. It is also important to quantify the response of the systems evaluated at high methane-emission rates (600 L/min). It is suggested that this work be done in the controlled environment of a full-scale test section.
3. There appears to be concern about the effectiveness of the various dust-control systems developed over the past two years in controlling dust in sections with very high production rates and when operating in different coal seams. To date, no evidence-based relationships have been determined between an increase in the production level, an increase in the dust-concentration level and the performance of the dust-control systems. From recent studies carried out in the USA by NIOSH, researchers have found that there is a relationship between coal rank and dust-generation potential. Determination of the propensity of various coal seams (types) towards dust generation would therefore be a more suitable approach for establishing potential exposure levels and the additional measures that will be needed to control the dust levels to below the required concentration.
4. Due to the dynamic nature of mining and the complex interaction between methane, dust and fresh air, it would be advisable to test the systems under low-seam mining conditions.
5. The directive on collecting dust samples at the operator's position and on monitoring should be reassessed to take into consideration the recent findings and current international trends.

6. No conclusive results were obtained with regard to the use of a wet cutter head in conjunction with the Bank 2000 Road Header Dust Control System due to the non-availability of suitable test sections. It is recommended that tests be carried out as soon as a wet head becomes operational to quantify its impact on methane and dust control. Such information will enhance the findings of this report.

It has been shown through this project that dust levels of below 5 mg/m^3 (at the road header operator's position) can be achieved through co-operation between all the parties concerned, i.e. mine management, production staff, maintenance staff and equipment manufacturers.

Glossary of abbreviations, symbols and terms

Abbreviations

Av.	Average
CDC	Colliery Dust Control Services
BCRL	Bituminous Coal Research Laboratory
BDCS	Bank 2000 Dust Control System
DCS	Dust Control System
DME	Department of Minerals and Energy
LEL	Lower Explosive Limit
LHS	Left-Hand Side
LTR	Last Through Road
NIOSH	National Institute of Occupational Safety and Health
OSS	Optimised Spray System
PBF	Pick Back Flush
RH	Road Header
RHS	Right-Hand Side
SA	South Africa
SC	Sample Concentration
SIMRAC	Safety in Mines Research Advisory Committee
TWA	Time-Weighted Average
TWA-CONC	Time-Weighted Average Dust Concentration
UK	United Kingdom
USA	United States of America
USBM	United States Bureau of Mines

Symbols

μm	micrometres/microns
kPa	kilopascal
kW	kilowatt
L/min	litres per minute
m	metre
m/s	metres per second
m^2	square metre
m^3/s	cubic metres per second
m^3/ton	cubic metres per ton
mg/m^3	milligrams per cubic metre
mm	millimetre

Terms

Wet head: A wet head system on continuous miners refers to water sprays mounted on the rotating cutting drum (head) of the machine close to each bit. In this system water is transferred to the sprays via the cutting drum. This differs from conventional external sprays in that water is sprayed directly onto the bit in the vicinity in which it is cutting coal. The drum water spray is strategically placed in the Pick Back Flushing (PBF) mode position to reduce the probability of incendive ignitions. The concept was developed in the 1970s by the former United States Bureau of Mines (USBM), the Bituminous Coal Research Laboratory (BCRL) and various manufacturers.

Acknowledgments

The authors wish to express their sincere gratitude and appreciation to the following people and organisations whose help and support made the completion of this project possible:

- Mr. Sarel W Pretorius, an independent contractor, for his contribution to the field tests and assistance.
- Mr. Walli Tallamaches, the management team and the underground personnel of Section 13 at Bank Colliery, South Shaft, for their help with the experimental set-up and general assistance.
- The Road Header Work Group for their invaluable support and valuable counsel during the various stages of this project.
- Field service teams of Locked Torque Africa and Colliery Dust Control (CDC) for assisting with the machine set-up and for their valuable contributions to the accomplishment of this work.
- The Underground Project Team members (dust and methane):
 - Mr. B K Belle, CSIR Miningtek
 - Mr. F J van Zyl, CSIR Miningtek
 - Mr. S W Pretorius, Sarel Stofmonster.

Table of Contents

	Page
<u>1</u> <u>Introduction</u>	13
<u>2</u> <u>Underground Evaluation</u>	17
<u>2.1</u> <u>Test section</u>	17
<u>2.2</u> <u>Instrumentation</u>	18
<u>2.2.1</u> <u>Dust monitoring</u>	18
<u>2.2.2</u> <u>Methane monitoring</u>	21
<u>2.3</u> <u>Data analysis</u>	23
<u>2.3.1</u> <u>Evaluation of dust-concentration levels</u>	23
<u>2.3.2</u> <u>Evaluation of methane concentrations</u>	24
<u>3</u> <u>The Bank 2000 RH Dust Control System (BDCS)</u>	24
<u>3.1</u> <u>General system description</u>	24
<u>3.2</u> <u>BDCS component description and evaluation</u>	25
<u>3.2.1</u> <u>On-board scrubber</u>	25
<u>3.2.2</u> <u>Water supply to the spray system</u>	26
<u>3.2.3</u> <u>Water spray nozzles</u>	26
<u>3.2.4</u> <u>Four-tube air mover</u>	26
<u>3.2.5</u> <u>Left-hand jib spray</u>	28
<u>3.2.6</u> <u>Cutter-head top block sprays</u>	29
<u>3.2.7</u> <u>Cutter-head side block sprays</u>	30
<u>3.2.8</u> <u>Jib frame sprays</u>	30
<u>3.2.9</u> <u>RH body sprays</u>	31
<u>3.2.10</u> <u>Physical scrubber curtain</u>	32
<u>3.2.11</u> <u>Flight conveyor throat sprays</u>	33
<u>3.2.12</u> <u>Concave spade plate</u>	33
<u>3.2.13</u> <u>Flight conveyor discharge cover</u>	35
<u>3.3</u> <u>The final BDCS</u>	36
<u>4</u> <u>Test Details and Results</u>	36
<u>4.1</u> <u>Background dust concentrations</u>	36
<u>4.2</u> <u>Underground test dust results: System 1- BDCS without the wet head</u>	37

4.2.1	Test conditions	37
4.2.2	Ongoing improvement philosophy	38
4.2.3	Test Week 1 (Tests 1 to 4) (System 1-1)	39
4.2.4	Test Week 2 (Tests 5 to 8) (System 1-2)	39
4.2.5	Test Week 3 (Tests 9 to 12) (System 1-3)	41
4.2.6	Test week 4 (Tests 13 to 17) (System 1-4)	42
4.2.7	Observations and results from the System 1 evaluations	43
4.2.8	Discussion of critical issues from the System 1 tests	46
4.3	Underground test dust results: System 2 - BDCS with wet head	48
4.3.1	System 2 components	48
4.3.2	Observations and results from the System 2 evaluations	49
4.3.3	Discussion of critical issues from the System 2 tests	53
4.4	Underground test methane results	54
4.4.1	General methane conditions encountered	54
4.4.2	In-heading gas release rate	54
4.4.3	Comments on methane monitoring	55
5	Conclusions	55
5.1	System 1: BDCS without the wet head	57
5.2	System 2: BDCS with the wet head	58
5.3	General conclusions	59

List of Figures

	Page
Figure 1: Optimised Spray System from surface trials	15
Figure 2.1: General layout of Section 13 at Bank Colliery, South Shaft	18
Figure 2.2.1a: Position of samplers at the section intake	20
Figure 2.2.1b: Position of samplers at the operator's position	20
Figure 2.2.1c: Position of samplers at the section return	21
Figure 2.2.1d: Position of samplers at the operator's position (mine sample)	21
Figure 2.2.2: Methane sensor placement on the RH	22
Figure 3.2.4a: Initial position of the four-tube air mover (Tests 1 to 8)	28
Figure 3.2.4b: Final position of the four-tube air mover (Tests 12 to 17)	28
Figure 3.2.5: Final position of the jib spray (B) (Tests 12 to 17)	29
Figure 3.2.7: Position of the cutter head sprays	30
Figure 3.2.8: Position of the jib frame sprays	31
Figure 3.2.9: Position of the RH body sprays	32
Figure 3.2.10: Physical scrubber curtain	32
Figure 3.2.11: Position of the air movers in the throat of the flight conveyor	33
Figure 3.2.12: Principle of operation of the concave spade plate	34
Figure 3.2.13: Flight conveyor discharge covers	35
Figure 3.3: Final configuration of the BDCS	36
Figure 4.1: Background dust-concentration data obtained from the mine	37
Figure 4.2.7a: Intake dust-concentration levels during the trials with the BDCS without the wet head	44
Figure 4.2.7b: Operator's dust-concentration levels during the trials of the BDCS without the wet head	45
Figure 4.2.7c: Return dust-concentration levels during the trials of the BDCS without the wet head	45
Figure 4.3.2a: Intake dust-concentration levels during the trials of the BDCS with the wet head	52
Figure 4.3.2b: Operator's dust-concentration levels during the trials of the BDCS with the wet head	52
Figure 4.3.2c: Return dust-concentration levels during the trials of the BDCS with the wet head	53

List of Tables

	Page
Table 2.1: Description of conditions in section	18
Table 2.2.2 Methane sensor specifications	21
Table 4.2.2: Test conditions for the BDCS without the wet head	38
Table 4.2.3: Average dust-concentration levels for the sampling period in mg/m³ for the BDCS without the wet head (Test Week 1)	39
Table 4.2.4: Average dust-concentration levels for the sampling period in mg/m³ for the BDCS without the wet head (Test Week 2)	40
Table 4.2.5: Average dust-concentration levels for the sampling period in mg/m³ for the BDCS without the wet head (Test Week 3)	42
Table 4.2.6: Average dust-concentration levels for the BDCS without the wet head (Test Week 4)	43
Table 4.2.7a: Summary statistics of dust-concentration levels (8-h TWA) for the BDCS without the wet head	46
Table 4.3.2a: Average dust-concentration levels in mg/m³ for the BDCS with the wet head ...	49
Table 4.3.2b: Summary statistics of dust-concentration levels (8-h TWA) for the BDCS with the wet head	51
Table 4.4.2: In-heading gas release rate of test section	54
Table 5: Summary of systems modification tests	57

1 Introduction

The 1995 report of the Leon Commission of Inquiry into Safety and Health in the South African Mining Industry led to the promulgation of the Mine Health and Safety Act of 1996. A directive of the South African Department of Minerals and Energy (DME, 1997) required the dust-concentration level to be reduced to below 5 mg/m^3 at the operator's cab position on continuous mining machines. In 1998, SIMRAC project COL 518 was successfully completed. The focus of this project was on finding ways of controlling the dust at the continuous miner operator's cabin to a concentration level of less than 5 mg/m^3 .

Project COL 603 was then formulated to ensure that the ventilation and dust-control systems in common use in the industry are able to create an environment in which the operator of a specific road header (RH) is not exposed, during normal cutting operations, to average dust-concentration levels of greater than 5 mg/m^3 .

Due to the considerable differences in the application and use of road headers (RH) and continuous miners (CM), the dust-control strategies that had been developed for CMs could not be directly applied to RHs. Also, ventilating the face area while a RH is cutting is more complex than with a CM because of the physical layout of the machine and the nature of the movement of the boom. The critical conditions in South African RH sections influencing environmental control are discussed in the Phase 1 literature review report (Hole and Belle, 1999).

The primary objective of this project (COL 603) was to minimise the dust exposure of workers while maintaining adequate ventilation conditions in RH headings in order to optimise the working environment of mine workers. The project was planned in various phases as follows:

Phase 1: Literature review

Phase 2: Surface trials at the IMCL gallery in Bretby (UK)

Phase 3: Underground trials in the South Shaft of Bank Colliery (SA).

During the first phase of the project, an extensive literature review of past international and South African research on best ventilation and dust-control practices was carried out jointly by

IMCL (UK) and CSIR Miningtek (South Africa). The details obtained from the literature review on the variety of ventilation systems currently in use, or which have been tried in South African mines and worldwide, were discussed in the Phase 1 report (Hole and Belle, 1999). The report gives an introduction to the various applications and uses of RHs worldwide for roadway development. It further focuses on best ventilation and dust-control practices in countries such as the UK, the USA, Germany and Poland and presents the main findings of relevant past South African research projects on ventilation and dust-control practices for RH machines.

In the second phase of the project (Hole, 2000), initial studies were carried out in a surface gallery at the IMCL laboratory in the UK. The objectives of the surface investigations were to evaluate and optimise existing ventilation and dust-control systems, identify non-functional systems and components, and provide recommendations for subsequent underground evaluations.

The surface trials successfully identified the main requirements for effective environmental control on RH machines, including the development of an Optimised Spray System (OSS). The surface trials did not take into account the effect of a wet-head cutter drum. The main findings of the surface trials are as follows (Hole, 2000):

1. Deflection of the scrubber discharge towards the upper corner of the roadway, diagonally opposite to the location of any floor-mounted force auxiliary ventilation column, provides optimum, consistent ventilation of the face.
2. Over the full range of ventilation conditions, the optimum location for the scrubber inlet was found to be ducted to a position just above the rear of the loading spade at the side of the machine. However, this location has some practical disadvantages regarding risk of damage. Furthermore, a satisfactory solution was identified in later work which enabled good results to be achieved with just a short extension (fitted to the standard inlet of the scrubber) taking the inlet to 5,0 m from the face, and this is a far more practical arrangement.
3. An OSS was developed which fulfils all the recognised ventilation requirements around the machine and at the face. Each element of the OSS is effective and fulfils a specific purpose. The system remained effective with 50% of the sprays blocked, although this

required the application of a marginally higher spray pressure of 30 bar compared with the 15 bar that was sufficient when all the sprays were operating. It should be remembered that when sprays become blocked, the water circuit pressure automatically increases. The OSS from the surface trials is shown in Figure 1 (Hole, 2000).

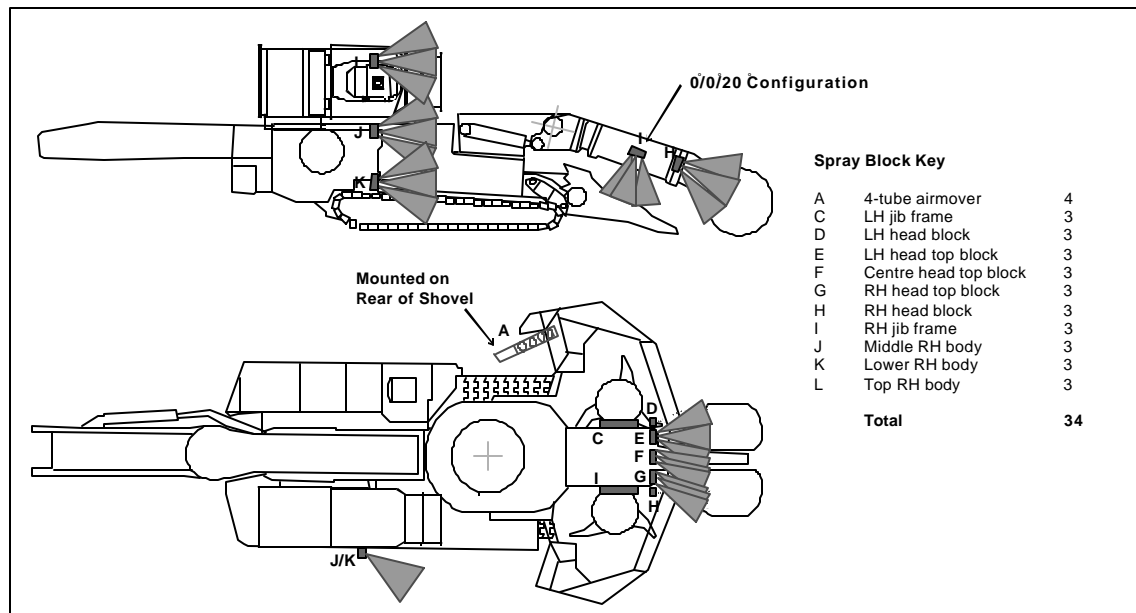

Figure 1: Optimised Spray System from surface trials

4. With regard to the spray nozzles used, the standard water spray nozzles (1,6 mm inlet/2,0 mm outlet) (Belle and Du Plessis, 1998) were used during the surface trials, except for the air mover tubes, which were each fitted with a twin-inlet orifice of the same nozzle. Although it would be desirable to use the same nozzles throughout the machine, with a nominal recommended spray pressure of between 15 and 30 bar, it was calculated that the use of single-inlet nozzles in the air movers would not give adequate air-moving performance.

5. An important feature of the spray arrangement was that the air movers needed to be located as close as possible to the face in order to be effective in ventilating the face. In the trials, a distance of 4,5 m between the tube inlets and the face was found to be too great, whereas a shorter distance of 3,7 m was found to give good results. In some respects, this scheme is specific to the arrangement of the machine in the specific gallery. In higher roadways, one or more additional air movers may be required. In addition, the spray configuration of blocks C and I is largely dependent on the maximum and minimum

angles of the machine jib in the section. In practice, the configuration of these blocks needs to take account of the requirement for adequate downward ventilation when the jib is raised, balanced against any tendency for the sprays to direct the dust cloud away from the face when the jib is lowered.

6. Full evaluation of the OSS revealed that the system gave good environmental control in a heading ventilated only by a scrubber. When force column ventilation was added, adequate control of dust became impossible. The problem was overcome through the use of a simple diffuser device on the discharge of the column. This device destroyed the jetting effect of the air released, while effectively ventilating the area behind the back of the machine and hence supplying fresh air to the on-board ventilation systems. This allowed a high standard of environmental control under the full range of ventilation conditions. On a cautionary note, however, in normal circumstances where the diffuser is located between 15 and 25 m from the face, it will play no part in ventilation of the face. Thus, a diffuser should not be used if either the scrubber or the air mover array is not working, or is significantly damaged.
7. The use of physical half-curtains can be advantageous to environmental control by raising the forward air velocities around the machine. However, these devices are generally only of major benefit at sites where no force auxiliary ventilation is used. Where force auxiliary ventilation with a diffuser is used together with a physical curtain, only a marginal advantage to environmental control may be apparent. If no diffuser is used on the force column, however, use of a physical curtain will result in severe deterioration in conditions around the machine due to turbulent, swirling flows around the edges of the screen. These turbulent flows draw contaminated, wet air back from the face to fill the area in front of the screen.

The evaluation of the ventilation and dust-control system proposed from the surface trials in an underground mine RH section was the main objective of the third phase of the project. The systems tested needed to comply with two main criteria, viz. adequate methane gas dilution at the face and keeping the respirable dust-concentration levels below 5 mg/m^3 at the operator's cabin.

The effectiveness of the ventilation systems was evaluated by using primary ventilation indicators, namely the methane gas concentration and the average dust-concentration levels. It was further decided that two dust-control systems should be evaluated in medium to high seam conditions, viz.

System 1: Road Header Dust Control System without a wet head

System 2: Road Header Dust Control System with a wet head.

This report discusses and summarises the results of the third phase, i.e. the underground evaluation tests carried out at Section No. 13 of Bank Colliery (South Shaft), and gives the details of the test conditions and the results of the individual systems tested.

2 Underground Evaluation

2.1 Test section

All the tests were conducted in a bord-and-pillar section utilising a Voest Alpine AM 85 road header. Figure 2.1 shows the typical deployment of the dust-monitoring instruments in the test section. The respirable dust-concentration levels in the section were determined by placing gravimetric respirable dust samplers along with Hund Tyndallometers at the sampling points. The sampler sets were positioned in the section intake, in the operator's cabin and in the section return.

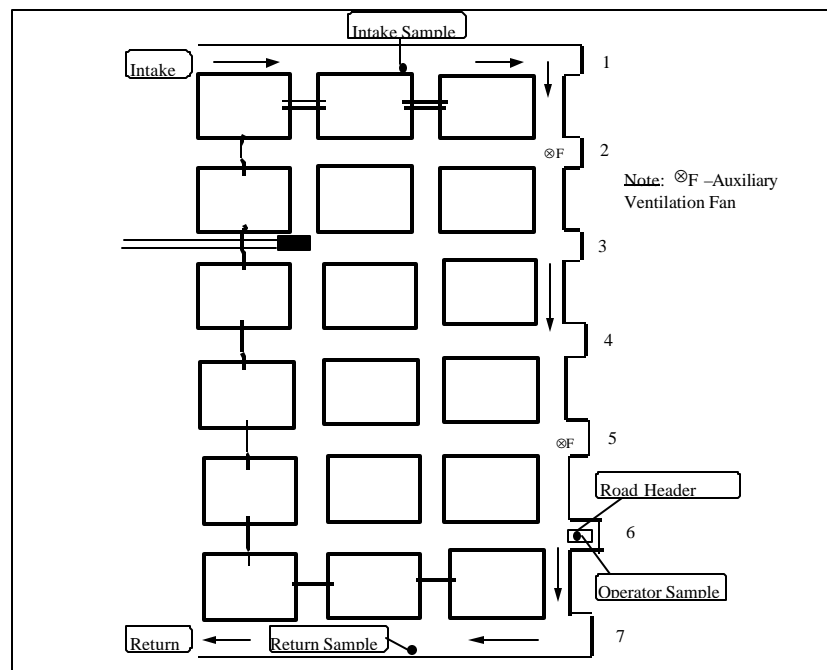

Figure 2.1: General layout of Section 13 at Bank Colliery, South Shaft

Methane levels were recorded on the boom of the RH near the cutting drum as this is the main area of concern for methane build-up.

No auxiliary ventilation was used in the section during the evaluation period.

Table 2.1 describes the mining conditions during the evaluation period. A total of 25 tests were conducted to evaluate the different systems: 17 tests to evaluate the RH DCS system without the wet head, and 8 tests to evaluate the RH DCS with the wet head present.

Table 2.1: Description of conditions in section

Description	Specification
Seam	Bank 2
Methane content, m ³ /ton	< 0,1
Seam depth, m	71
Seam height, m	5,5
Bord width, m	6,50
Pillar centre, m	20×20
Pillars, m	13,5×13,5

2.2 Instrumentation

2.2.1 Dust monitoring

Dust sampling equipment consisted of gravimetric samplers (Higgins-Dewell-type cyclone sampler - GME 008 cyclone) and real-time respirable dust monitors (Hund Tyndallometers). Gravimetric samplers were used to determine the average respirable dust concentrations during a production shift.

A pair of gravimetric samplers was positioned at the section intake (Figure 2.2.1a). At the operator's position and section return, two gravimetric samplers and a real-time respirable

dust monitor were positioned, as shown in Figures 2.2.1b and c respectively. The average gravimetric respirable dust concentration determined for the sampling period was used to convert the Hund readings to mass concentrations (mg/m^3).

The gravimetric sampler train consisted of an air pump which draws 2,2 L/min of air through a mini-cyclone, which in turn separates the airborne dust and collects only the fraction of respirable dust ($<10 \mu\text{m}$) on a pre-weighed filter disc. At the stipulated flow rate of 2,2 L/min, the instrument conforms to the new USA, UK and European respirable dust curve with a D_{50} of $4 \mu\text{m}$. The dust samples were then weighed and the procedure for determining the particulate mass was followed according to DME guidelines (1994).

Regulatory dust samples were gathered by the mine using a GME 008 Higgins-Dewell-type cyclone sampler, collecting the respirable dust from the mine atmosphere at a flow rate of 1,9 L/min. The sampling train was placed at the operator's position (i.e. positioned at the back of the RH as shown in Figure 2.2.1d). The sampling pump was switched on in the section prior to production commencing, and switched off at the end of the production shift in the section.

An engineering sample was taken at the RH operator's position. The engineering sampler was switched on in the face area at the beginning of the shift where the cutting machine was standing and was switched off at the end of the shift. An engineering sample enables the effectiveness of the dust-control and ventilation systems in the section to be determined, as well as the administrative efficiency of the mine environmental management. The engineering sample is not collected for the entire 8-h period since it excludes the travel time.

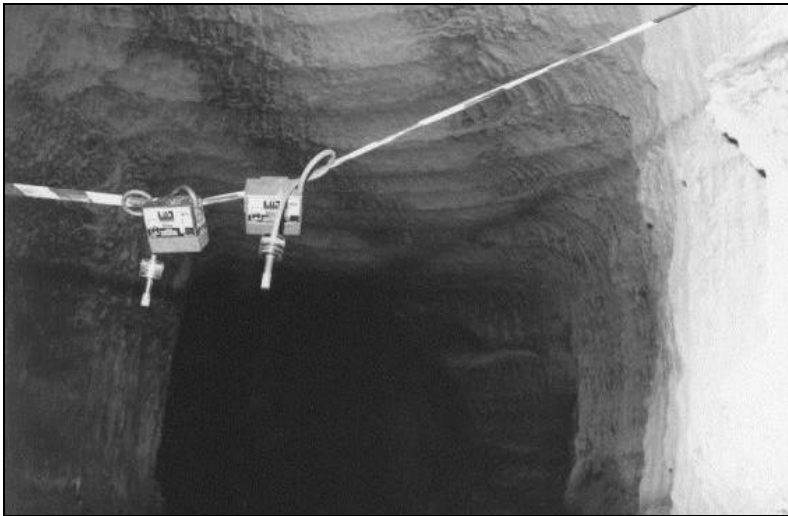

Figure 2.2.1a: Position of samplers at the section intake



Figure 2.2.1b: Position of samplers at the operator's position

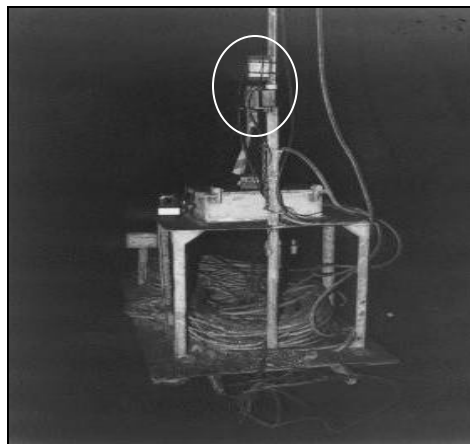

Figure 2.2.1c: Position of samplers at the section return



Figure 2.2.1d: Position of samplers at the operator's position (mine sample)

2.2.2 Methane monitoring

During the test series, two types of methane sensor were used, viz. the Crowcon Triple Plus and the Crowcon Custodian. Both methane sensors were of the pellistor type. The sensor specifications and details are summarised in Table 2.2.2.

Table 2.2.2 Methane sensor specifications

Specifications	Crowcon Custodian	Crowcon Triple Plus
Operating principle	Pellistor	Pellistor
Level recorded	Lower Explosive Limit (LEL)	LEL
Flammable gas LEL range (%)	0 to 5 in air	0 to 5 in air
Response time, open (T_{90}) (s)	20	20
Response time, in box (T_{90}) (s)	35	35
Operating temperature range (°C)	-20 to 50	-10 to 50
Humidity operating range (% RH)	0 to 95 non-condensing	0 to 90 non-condensing

Both types of sensor are equipped with data-logging abilities. The recording interval was set to 10 seconds. Although this response time interval is lower than the T_{90} response time, a good indication of the methane gas trends can be obtained.

To protect the methane sensors from the harsh environment around an active RH, the

Custodian sensors were placed in polycarbonate boxes. The sensors were exposed to the environment via 70 x 3 mm holes drilled into the box-lid at the location of the heads on the sensors. By enclosing the sensors in the box, the T_{90} response was increased from 20 to 35 seconds. Although the response time is increased by the addition of the protective box, a representative indication of the general methane conditions around the RH can be determined.

The methane levels around the RH were measured continuously during the test period. They were monitored at three locations around the RH (Figure 2.2.2).

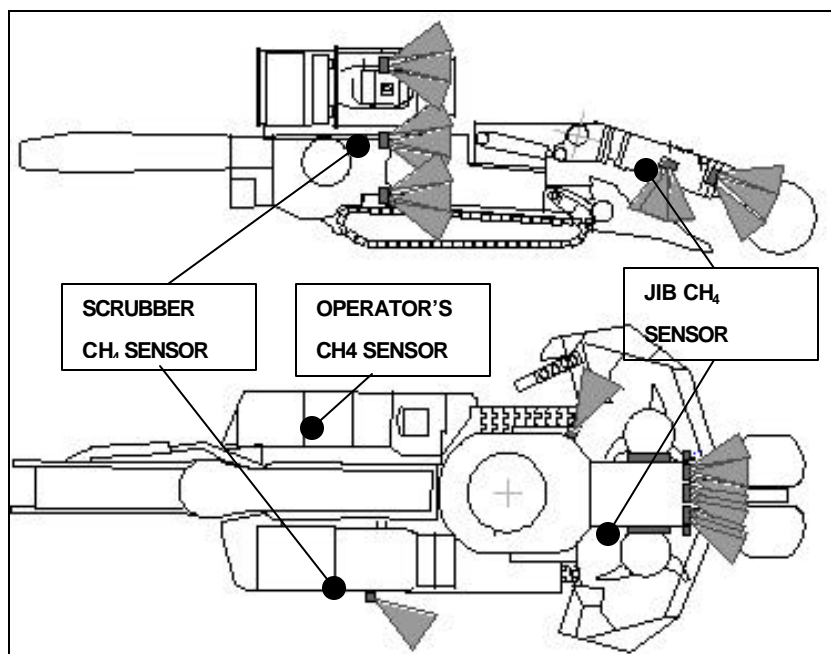

Figure 2.2.2: Methane sensor placement on the RH

Before starting a test, the methane sensor batteries were charged, the methane sensor memory was cleared, and the sensor calibration was checked with 1,5% VV methane in air at a flow rate of 0,5 L/min. Thereafter, the Custodian methane sensors were placed in their protective boxes.

At the beginning of a test shift, the methane sensors were switched on and the time was noted. The Custodian methane sensors were then placed on the RH, one at the operator's cab position and the other on the jib. The jib sensor was approximately 2,5 m from the face

during cutting on the return-air side. The Triple Plus sensor was placed under the dust scrubber unit.

During the test period, the RH activity and location were monitored and any major events that might influence the ventilation conditions, e.g. methane levels, were noted against time. Typical events that occur are stoppages in production, different locations of the RH (heading or split), switching on and off of auxiliary ventilation systems, etc.

After completion of the test shift, the sensors were removed from the RH, switched off and the time was noted. The stored data from the sensors were then downloaded on surface, and the pre-test procedure as described above was applied. The downloaded data were then imported into a spreadsheet for data analysis. Any “abnormal” peaks or lows were checked against the time study log to explain the occurrence.

During the first week of testing, both Custodian sensors were placed in protective boxes. However, due to the low methane levels recorded, it was decided to remove the protective box from the sensor placed in the operator’s cab position. This procedure was followed for the remainder of the test series (van Zyl, 2000).

2.3 Data analysis

2.3.1 Evaluation of dust-concentration levels

The dust concentrations presented throughout this report reflect respirable gravimetric dust measurements taken over a full production period (from the beginning of a shift to the end of that shift). This production period was either equal to but never greater than eight hours during any of the test shifts. Approximately an hour was spent on travelling to and from the section. Real-time dust-sampling results allow the comparison of face-area dust concentrations under different ventilation and mining conditions. Using the mass of dust collected on the filters, the sample dust concentration is obtained as follows:

$$\text{Sample Dust Concentration (SC)} = \frac{(C_f - C_i)}{Fl \times T} \quad (1)$$

where: SC = sample dust concentration measured in mg/m³
 C_i = corrected initial filter mass in mg
 C_f = corrected final filter mass containing dust in mg
 FI = sample flow rate in m³/min
 T = sampling time in min

Since the dust sampling was carried out for the entire production period of the shift (excluding travel time), an 8-h time-weighted average dust concentration (TWA 8-h) is obtained as

$$\text{TWA} - 8\text{h} = \frac{((\text{SC} \times \text{T}_s))}{480} \quad (2)$$

follows:

where: SC = sample dust concentration measured in mg/m³
 T_s = sampling time in min

Environmental officers in the mines use the above equation (2) to determine the average shift dust-concentration levels.

2.3.2 Evaluation of methane concentrations

The methane levels recorded from the three methane sensors are plotted on the same graph depicting gas concentration vs. time. In conjunction with the RH activity sheet, the graphs are used to determine general airflow patterns around the RH, identify locations and situations where methane dilution is not optimal, and determine general methane levels in the heading during production.

3 The Bank 2000 RH Dust Control System (BDCS)

3.1 General system description

The DCS system that was developed for the RH at Bank Colliery, South Shaft, is known as the "Bank 2000 Road Header (RH) Dust Control System (BDCS)". The name was chosen to distinguish this DCS from the various DCSs currently deployed in South African mines.

The original BDCS is based on the OSS configuration developed for the underground Voest Alpine AM 85 RH by IMCL in the surface trials, and is shown in Figure 3.1. The long headings found in South African coal mines (>24 m), and the potential use of auxiliary ventilation devices such as jet fans or force fans were kept in mind when the OSS configuration for the BDCS was being developed. The configuration of the sprays as installed on the AM 85 RH incorporates a number of water spray blocks (11), a four-tube air mover and an on-board scrubber. The system consists of a total of 34 sprays (30 x 1,6 mm single-inlet/2,0 mm outlet sprays for the spray blocks, and 4 x 1,6 mm twin-inlet/2,0 mm outlet sprays for the air mover) operating at a water pressure of between 15 and 20 bar. A detailed description of the system components, as shown in Figure 3.1, is given in the following sections.

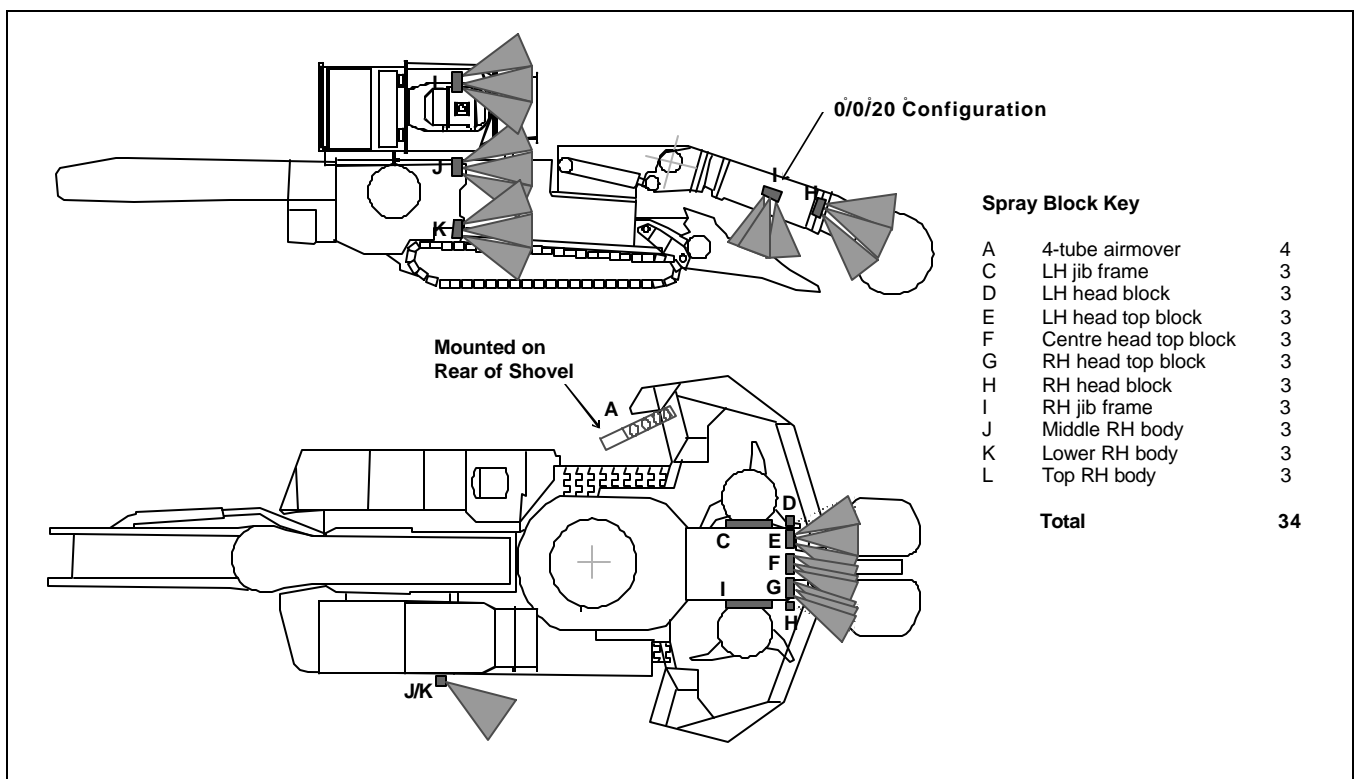

Figure 3.1: Recommended OSS configuration from surface trials

3.2 BDCS component description and evaluation

3.2.1 On-board scrubber

A 17 m³/s wet fan scrubber fitted with an inlet cone and a scrubber-outlet deflector plate directing discharged air towards the corner of the roof and sidewall at a 45° angle (Figure 3.1)

is used on the system. The size of the scrubber is based on regulatory requirements for heading ventilation.

3.2.2 Water supply to the spray system

Water is supplied to the BDCS at a pressure in the range of 1 500 kPa (15 bar) to 2 000 kPa (20 bar). The associated water flow required is approximately 120 L/min. The water pressure prescribed is the optimum pressure required by the sprays to ensure optimum spray droplet size and cone formation.

3.2.3 Water spray nozzles

The sprays used in the spray blocks are standard hollow-cone nozzles with a single-inlet diameter of 1,6 mm and an outlet diameter of 2,0 mm. The spray nozzles for the four-tube air mover are twin-inlet 1,6 mm/2,0 mm outlet hollow-cone nozzles. These were identified as the best nozzles for dust control application in coal mines.

3.2.4 Four-tube air mover

From surface trials it was recommended that a single four-tube air mover (Figures 3.2.4a and b) be positioned on the LHS spade of the RH, 3,7 m from the face, and that it be directed towards the LHS corner of the face. The primary purpose of the air mover was to aid the flow of fresh air around the machine for flammable gas dilution and to ensure effective ventilation of the face on the side furthest from the scrubber inlet, particularly when there is no additional auxiliary ventilation. An additional function of the air mover was to contain dust in the face area and guide it towards the scrubber inlet.

From the underground trials, in the absence of force auxiliary ventilation, it was found that the effect of the air mover (Figures 3.2.4a and b) is negligible at the optimum pressure range of 15 to 20 bar. This was especially evident when the RH was cutting the first cut at the top of the face. The dust generated during the cutting, coupled with the coal falling from a height of approximately 5 m, overwhelmed the air mover, spilling large amounts of airborne dust past the air mover towards the operator's position. This rendered the air mover ineffective in suppressing or containing dust in the face area. After eight tests, the air mover array was judged to be ineffective and was relocated to the top of the RH computer box, as shown in

Figure 3.2.4b. At this position, the air mover is more effective as the dust cloud has lost most of its energy, allowing the ventilation energy to control the dust cloud better.

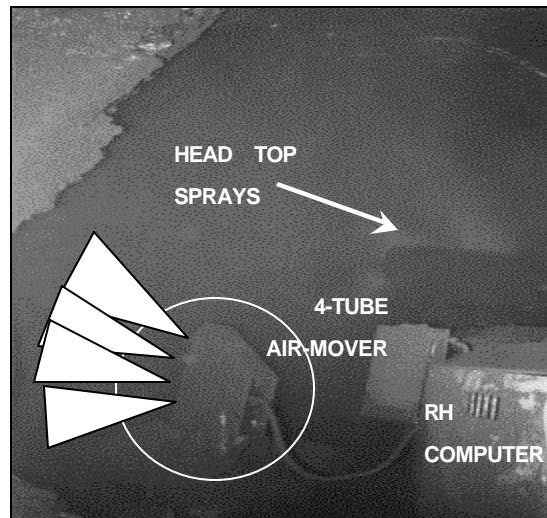

Figure 3.2.4a: Initial position of the four-tube air mover (Tests 1 to 8)

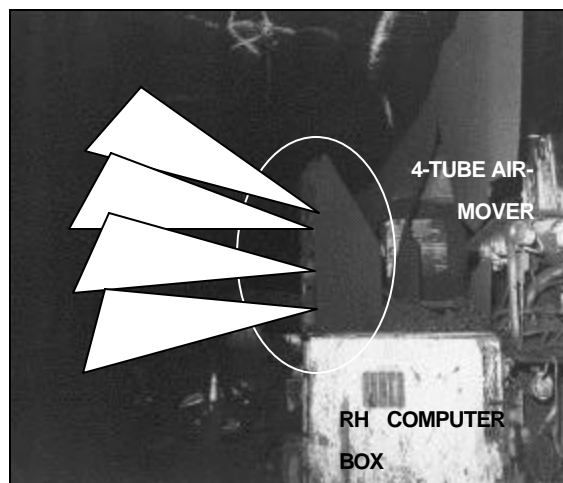

Figure 3.2.4b: Final position of the four-tube air mover (Tests 12 to 17)

3.2.5 Left-hand jib spray

In the original OSS design it was found that the jib spray (Figure 3.2.5) did not significantly improve the ventilation and dust control around the RH. The jib spray consisted of a four-spray dovetail spray block mounted vertically on the jib, at an angle of 45° relative to the centre line of the jib (Figure 3.2.5).

From underground trials, however, it was found that the jib spray does assist the four-tube air mover in keeping the dust cloud generated by the falling coal and the cutting process in front

of the operator's position, especially during the first cut at height. This improves the dust-capture efficiency of the scrubber, and hence general in-heading dust levels. The jib spray also assists by 'sweeping' the face under the jib during cross-cutting. The optimal position for the jib spray block is at an angle of 45° relative to the centre line of the jib, forming a vertical spray curtain. The spray block must be mounted in such a manner that when the jib is cutting the top of the face, the spray block will be parallel to the ground.

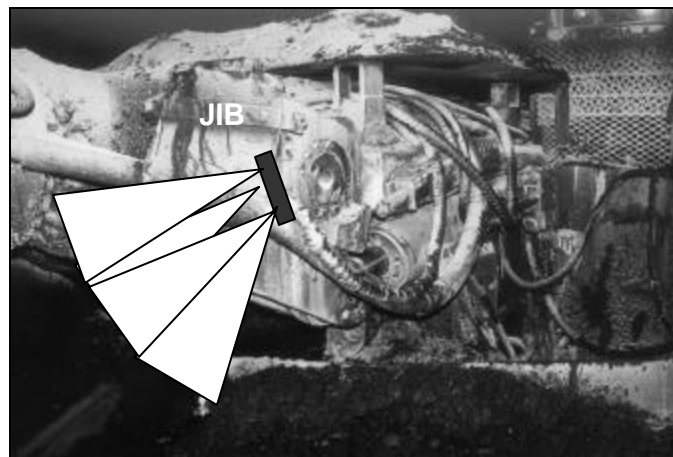
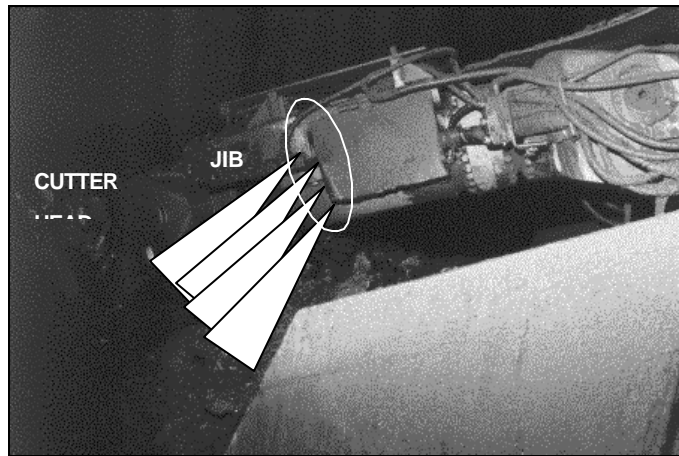

Figure 3.2.5: Final position of the jib spray (B) (Tests 12 to 17)

3.2.6 Cutter-head top block sprays

To ensure maximum dust suppression at source, i.e. at the cutting head, nine horizontally mounted directional water sprays are used. They are located in three spray blocks on the jib, immediately behind the cutting head (Figure 3.2.7). These sprays are arranged in a 'spray-fan' pattern, generally angled to one side to promote 'sweeping' ventilation of the face.

3.2.7 Cutter-head side block sprays

To assist the nine horizontal cutter-head sprays in suppressing the dust generated at source, a further three sprays were mounted vertically on either side of the cutter head. These were located in dovetail spray blocks mounted on the jib behind the cutter head (Figure 3.2.7). These sprays covered the corners of the cutting drum.

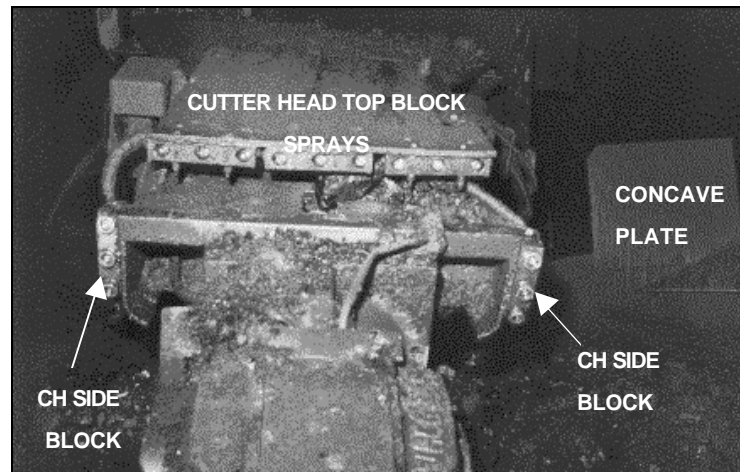

Figure 3.2.7: Position of the cutter head sprays

3.2.8 Jib frame sprays

To contain the dust generated by falling coal and the cutting process under the jib, particularly in the loading zone, two jib spray blocks were mounted on either side of the jib (Figure 3.2.8). The spray blocks consisted of three sprays each mounted to spray down at a 90° angle with the jib. The front spray of each block was at an angle of 20° relative to the jib. Since these spray blocks were mounted on the sides of the jib, the influence of the spray blocks varies as the jib is raised and lowered.

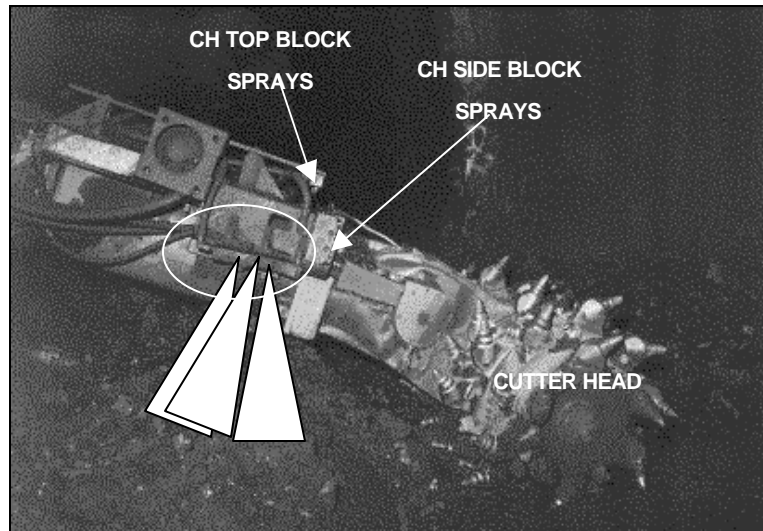

Figure 3.2.8: Position of the jib frame sprays

3.2.9 RH body sprays

To minimise the amount of dust-laden air bypassing the scrubber inlet, two RH body spray blocks were mounted on the RH just behind the scrubber intake (Figure 3.2.9). These spray blocks are of the dovetail type fitted with three hollow-cone sprays each. As the pressure drop around the scrubber intake is enhanced through the use of a curved intake, hence increasing dust capture in this area, the RH body sprays were only mounted below the scrubber intake. Overall, the use of these spray blocks helped to contain the dust cloud in front of the scrubber intake, improving the scrubber's dust-capture efficiency. The necessity for an additional spray block located higher on the RH depends mainly on the water supply and pressure available and on the seam height being mined. During the underground tests, an additional block as recommended in the surface trials was not used.

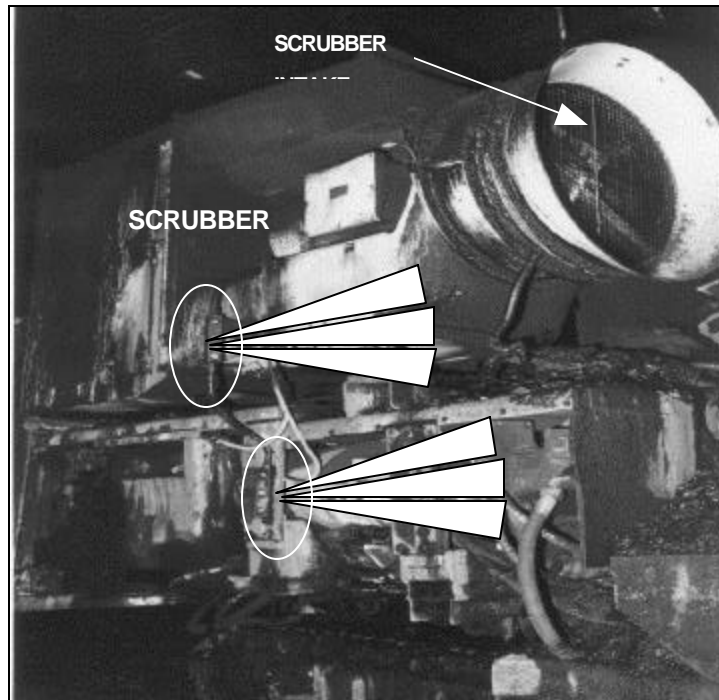

Figure 3.2.9: Position of the RH body sprays

3.2.10 Physical scrubber curtain

It was observed from the underground trials that in order to improve the scrubber efficiency, dust must not be allowed to escape past the scrubber intake near the roof and the RH operator's position. To increase the dust-capture efficiency of the scrubber, a physical curtain was placed over the scrubber unit (Figure 3.2.10).

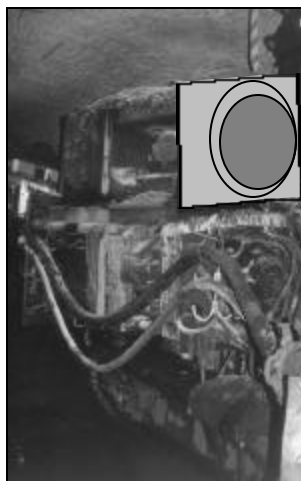

Figure 3.2.10: Physical scrubber curtain

3.2.11 Flight conveyor throat sprays

The purpose of the three air movers positioned in the throat of the flight conveyor (Figure 3.2.11), spraying downwards at an angle greater than 45° from the horizontal onto the flight conveyor, is to prevent dust rollback and to wet the coal on the flight conveyor (during the surface trials these were not used).



Figure 3.2.11: Position of the air movers in the throat of the flight conveyor

3.2.12 Concave spade plate

As mentioned in Section 3.2.4, it was observed that when the RH was cutting the top LHS of the heading, the energy of the dust cloud (due to the height of the coal fall) totally overpowered the four-tube air mover, pushing significant amounts of airborne dust past the RH spade towards the operator's position. This situation continued despite the relocation of the four-tube air mover and resulted in the RH operator's position being exposed to frequent very high dust-concentration levels (see Appendix A, Figures, A1, A2, A4, A6, A8, A10 and A12). To counter the high energy of this dust cloud, it was decided to place a physical obstacle in the way of the cloud to deflect the energy back towards the face. This was achieved by placing a concave spade plate on the LHS of the RH spade (Figure 3.2.7).

The principle of operation of the concave spade plate, as shown in Figure 2.3.12, will now be explained. The concave spade plate is approximately 75 cm high and 55 cm wide and is positioned at the back of the spade shoulder. The concave shape of the plate deflects the dust cloud up and back into the face, preventing the full force of the dust cloud from striking the

four-tube air mover, hence improving dust control in the region of the operator's position.

In the case where auxiliary ventilation, such as a jet fan and force column, is to be used, the effectiveness of the concave plate will need to be reassessed.

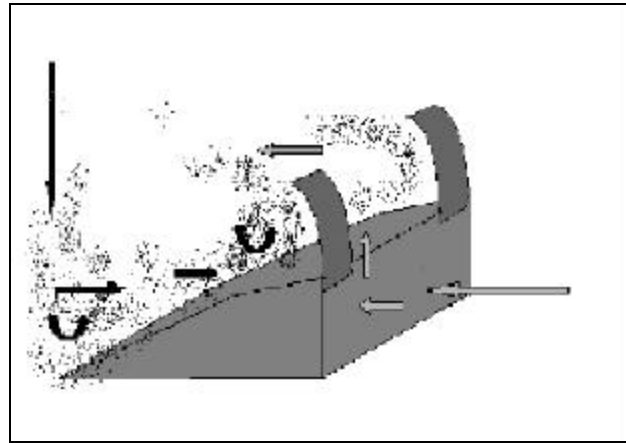

Figure 3.2.12: Principle of operation of the concave spade plate

3.2.13 Flight conveyor discharge cover

During the underground trials it was observed that a noticeable amount of dust was released when coal was discharged from the flight conveyor into the shuttle cars, despite the air movers in the flight conveyor's throat wetting the coal. To reduce this problem, pieces of conveyor belt were placed at the discharge point, with good results being obtained (Figure 3.2.13).

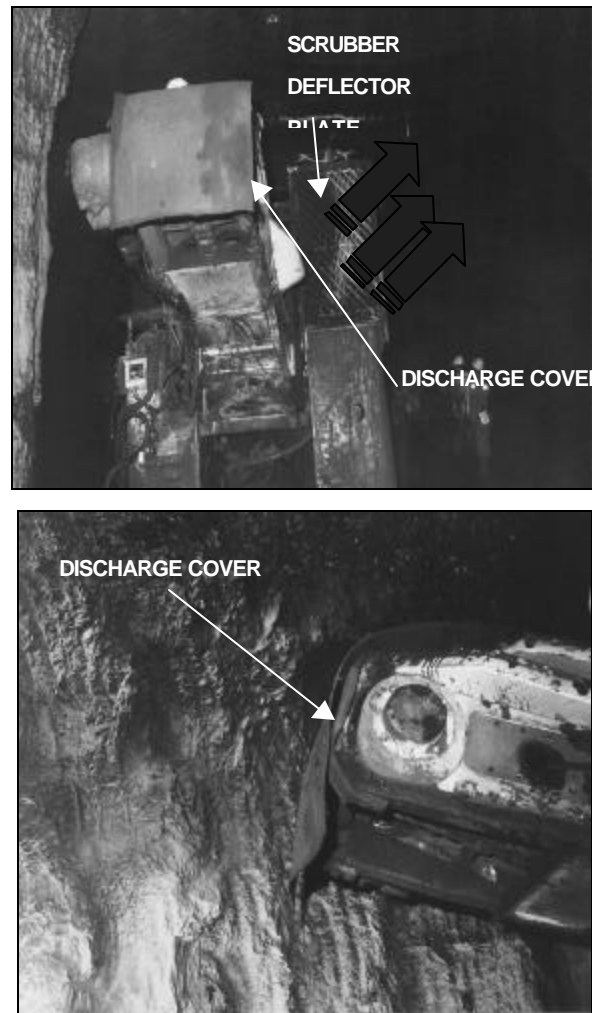

Figure 3.2.13: Flight conveyor discharge covers

The figure shows that the deflector plates on the scrubber discharge were angled at 45°. This configuration does not only improve the general in-heading ventilation, but also reduces the air movement at the flight chain conveyor discharge point, reducing dust pick-up.

3.3 The final BDCS

Based on the underground observations and evaluation, as discussed above, the OSS was modified to address the needs and shortcomings found during the underground trials. The final BDCS is depicted in Figure 3.3.

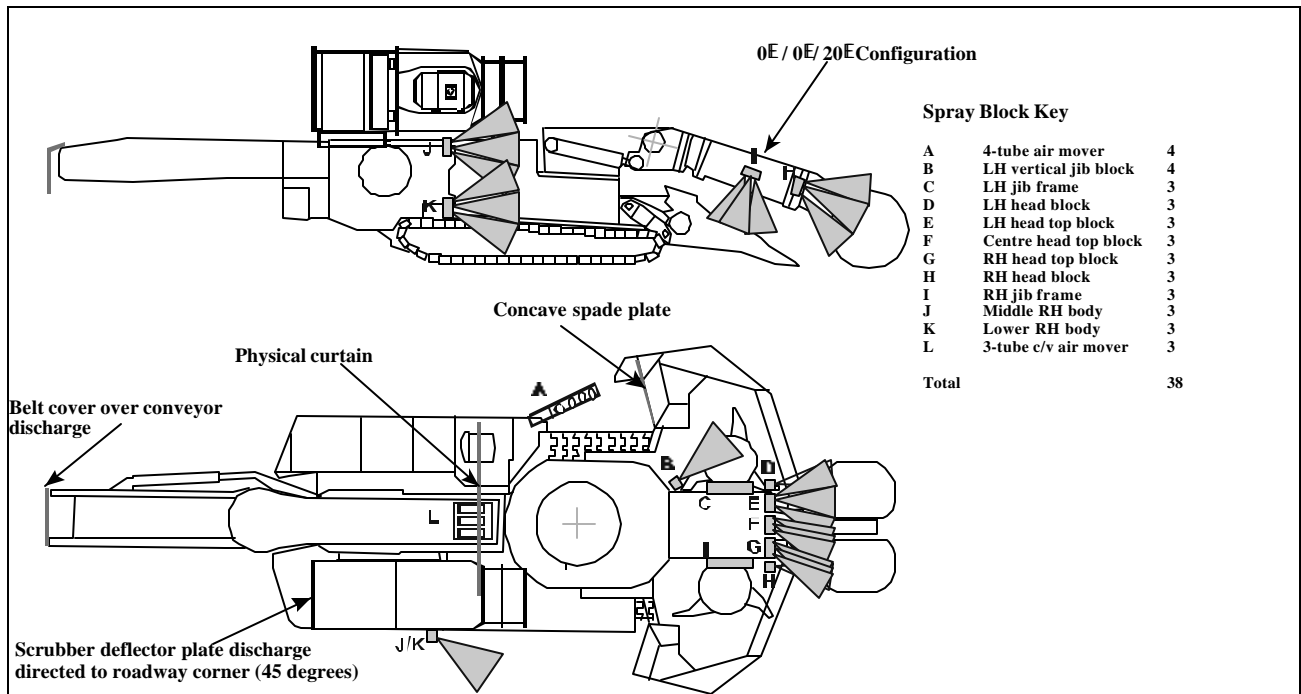

Figure 3.3: Final configuration of the BDCS

4 Test Details and Results

4.1 Background dust concentrations

To detect any improvement in the existing dust-control system at the mine, the dust concentrations measured by the mine were obtained for comparison purposes. The data for the three months prior to the new system being implemented are shown in Figure 4.1. These data were obtained from the mine records. For the 28 eight-hour production shifts, the average measured dust concentration was $10,83 \text{ mg/m}^3$, with the minimum and maximum measured gravimetric dust concentrations for a shift period being $3,23$ and $28,6 \text{ mg/m}^3$ respectively. (As before, the actual sampling period was less than eight hours.) The actual sampling period concentration was converted to the TWA (8-h) (see Section 2.3.1).

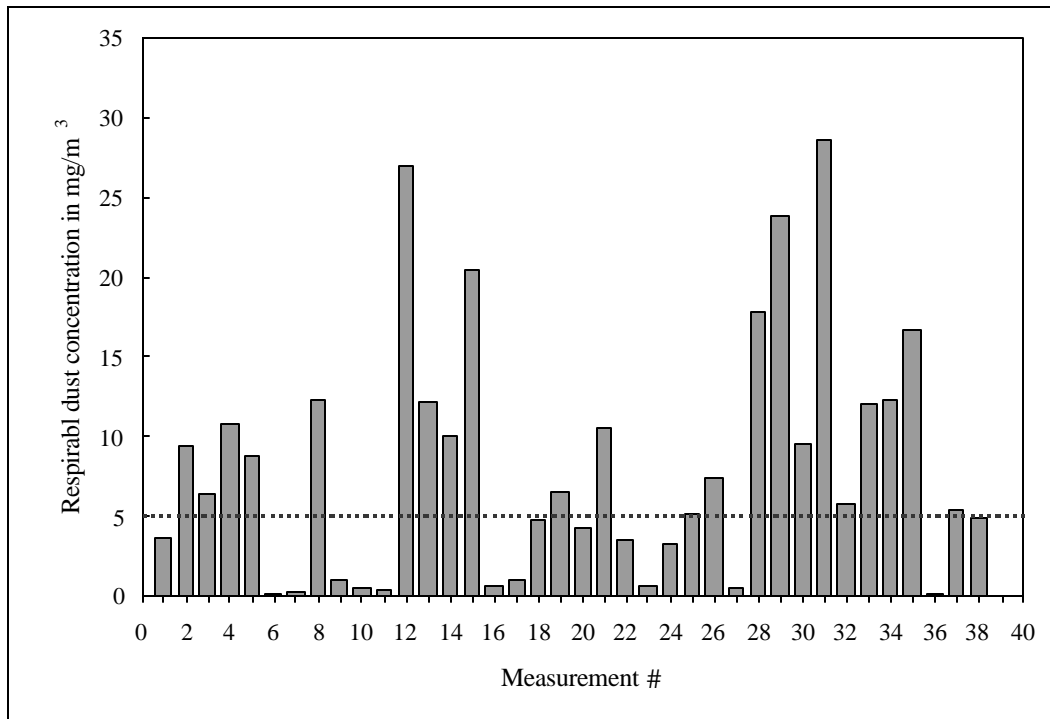

Figure 4.1: Background dust-concentration data obtained from the mine

From the plot we observe that for 22 of the 28 (79%) production shifts, the dust concentrations at the operator's position in Section 13 did not comply with the regulatory level of 5 mg/m³.

4.2 Underground test dust results: System 1- BDCS without the wet head

4.2.1 Test conditions

A total of 17 tests were conducted on the BDCS without the wet head. In all the underground tests, no auxiliary ventilation devices such as force fans or jet fans were used. During the tests, the total water flow rate to the dust-suppression system was approximately 120 L/min at pressures of between 1 500 and 2 000 kPa (15 to 20 bar). The dust-suppression system consisted of 38 sprays, including seven air movers, i.e. three on the flight conveyor and a four-tube air mover on the LHS of the computer box (Figure 3.3).

4.2.2 Ongoing improvement philosophy

During the underground evaluation of the BDCS it was found that some components of the system had to be changed to address shortcomings that had been identified during the underground trials.

To optimise the BDCS, a number of critical changes were made during the underground tests to achieve the desired environmental conditions. These were:

- Moving the four-tube air mover to the computer box
- Incorporating the 45 ° deflector plate on the scrubber discharge
- Adding the concave spade shoulder plate
- Adding the flight conveyor discharge cover
- Adding the left-hand jib spray (pedestal spray).

The test conditions and the changes that improved dust control at the operator's position from Tests 1 to 17 are summarised in Table 4.2.2.

Table 4.2.2: Test conditions for the BDCS without the wet head

Test No.	WP, bar	S	C	D	F	J	SC	TWA 8-h
1 to 4	5-8	PS	A	A	A	A	3,63	2,78
5 to 8	16	S*	A	A	A	A	6,42	5,06
9 to 11	16	A	A	A	A	P	6,32	5,15
12	16	S**	P	A	P	P	6,37	5,49
13 to 17	16	S**	P	P	P	P	3,51	2,54

WP – Water pressure; S - Four-tube air mover on the spade position; C - Spade concave plate; D - 45° deflector plate directing the discharge to the roadway corner; F - Flight conveyor belt cover; J – Left-hand jib sprays; SC: -Operator dust-concentration level for the sampling period; TWA 8-h: 8-h TWA operator dust-concentration level; S* - Four-tube air mover on the spade position but not working; S** - Four-tube air mover present at the RH computer box; P - Present, A – absent.

4.2.3 Test Week 1 (Tests 1 to 4) (System 1-1)

In the first four tests, the four-tube air mover was positioned at the spade plate. Table 4.2.3 shows the dust-concentration levels at the intake, operator and return during the sampling period for the BDCS without the wet head.

Table 4.2.3: Average dust-concentration levels for the sampling period in mg/m³ for the BDCS without the wet head (Test Week 1)

Test No.	Sample Position			Road Header Section Details		
	Intake (mg/m ³)	Operator (mg/m ³)	Return (mg/m ³)	Road #	H or S	Production in tons
1	0,45	3,42	1,08	4,3	SL	630
2	1,84	6,29	2,43	4,5	SR	630
3	0,40	1,89	0,57	7	H	500
4	0,23	2,89	1,27	2	H	760

The calculated average dust-concentration levels (Tests 1, 2, 3 and 4) at the operator's position and section return during the sampling period were 3,63 mg/m³ and 1,34 mg/m³ respectively. Similarly, the determined TWA (8-h) dust-concentration levels at the operator's position and return position were 2,78 mg/m³ and 1,01 mg/m³ respectively. In Appendix A (Figures A1 to A4), the real-time respirable dust-concentration level plots for Tests 1 to 4 are shown.

During the tests it was observed that the falling coal produced a dust cloud strong enough to overpower the dust-capturing and control capacity of the spade air mover positioned on the LHS. This resulted in frequent very high dust levels being recorded at the operator's cab and the remote operator's position.

4.2.4 Test Week 2 (Tests 5 to 8) (System 1-2)

At the beginning of the second week of testing (Tests 5 to 8), the following changes were made (implemented according to original specifications):

- The water pressure to the external spray system was increased from 8 bar to between 15 and 18 bar, and all the water leakages were fixed.
- The physical half-curtain was moved forward from its initial position to 1,0 m behind the scrubber intake.
- All the nozzles were replaced with nozzles complying with the 1,6 mm/2,0 mm specification. The LHS and RHS spray blocks were replaced with dovetail blocks (D and H).
- The water supply to the spade air mover position was disconnected, and the spade air mover itself was used as a physical shield.

Table 4.2.4 shows the dust-concentration levels at the intake, operator and return during the sampling period for the BDCS without the wet head.

Table 4.2.4: Average dust-concentration levels for the sampling period in mg/m³ for the BDCS without the wet head (Test Week 2)

Test No.	Sample Position			Road Header Section Details		
	Intake (mg/m ³)	Operator (mg/m ³)	Return (mg/m ³)	Road #	H or S	Production in tons
5	0,55	4,00	1,42	6	H	840
6	0,22	10,44	2,49	6,7,4	SR,H	1 220
7	0,36	4,45	5,53	1,4,3	H,SL	800
8	0,49	6,77	5,74	4,5,6	SR,H	1 260

The total dust cloud generated from the falling coal during top cutting was partially contained by the non-operational four-tube air mover positioned on the LHS of the spade. The external sprays were able to wet both the roof and the face area. The addition and repositioning of the physical half-curtain was very effective. It kept the dust cloud in front of the operator's cabin. A few small openings had to be cut in the curtain so as to give the RH operator some view of the face area while cutting.

When the RH was cutting beyond 20 m from the LTR, smooth air flow in the heading was lost in the absence of the shuttle car. However, when the shuttle car was present, the air was

directed from the operator's side towards the face. When the RH was cutting the bottom half of the face area, the operator's position was clean and clearly visible.

When the flight conveyor was partially blocked by large chunks of coal, additional dust was generated due to friction between the flight chain and the blocking coal, releasing more airborne dust from the flight conveyor. In the absence of the 45° deflector plate on the scrubber outlet, the dust was pushed in the direction of the shuttle car operator's position.

The calculated average dust-concentration levels (Tests 5 to 8) at the operator's position and section return during the sampling period were 6,42 mg/m³ and 3,8 mg/m³ respectively. Similarly, the determined TWA (8-h) dust-concentration levels at the operator and return positions were 5,06 mg/m³ and 3,02 mg/m³ respectively. In Appendix A (Figures A5 to A8), the real-time respirable dust-concentration level plots for Tests 5 to 8 are shown.

4.2.5 Test Week 3 (Tests 9 to 12) (System 1-3)

In addition to the changes made from Tests 1 to 8, the following changes were made for Tests 9 to 12:

- The spade air mover was removed and repositioned on the front of the RH body, as shown in Figure 3.2.4b (on the computer box). However, for Tests 9 and 12 the air movers were not effective as they were connected to the low water pressure side.
- A jib spray block as shown in Figure 3.2.5 was added to increase the effectiveness of the curtain of water sprays formed to prevent dust rollback towards the operator's position and to suppress the total dust from the dust cloud generated by falling coal.
- During Tests 8 to 11, no four-tube air mover was present at the LHS spade position of the RH. This created a situation in which there was no physical barrier for the total dust pushed back by the falling coal from top cutting.
- In Test 12, a new concave spade plate was added and the flight conveyor discharge area was covered with a conveyor belt, preventing the fine dust adhering to the cut coal from becoming airborne.

Table 4.2.1d shows the dust-concentration levels at the intake, operator and return positions during the sampling period for the BDCS without the wet head.

Table 4.2.5: Average dust-concentration levels for the sampling period in mg/m³ for the BDCS without the wet head (Test Week 3)

Test No.	Sample Position			Road Header Section Details		
	Intake (mg/m ³)	Operator (mg/m ³)	Return (mg/m ³)	Road #	H or S	Production in tons
9	1,73	5,52	2,44	5,4,3	H,SL	760
10	0,62	8,59	2,59	6,4	H,H	1 680
11	0,91	4,85	8,56	5	H	1 050
12	0,31	6,37	9,15	6,6,7,4,3,3,2	H,SR,SL, SL	760

The calculated average dust-concentration levels (Tests 9 to 12) at the operator's position and section return during the sampling period were 6,33 mg/m³ and 5,69 mg/m³ respectively. Similarly, the determined TWA (8-h) dust-concentration levels at the operator and return positions were 5,24 mg/m³ and 4,77 mg/m³ respectively. In Appendix A (Figures A9 to A12), the real-time respirable dust-concentration level plots for Tests 9 to 12 are shown.

4.2.6 Test week 4 (Tests 13 to 17) (System 1-4)

For Tests 13 to 17, the following final elements of the dust-control system were operational:

- Hollow-cone single-inlet spray nozzles (1,6 mm (inlet) / 2,0 mm (outlet))
- Physical half-curtain around the scrubber
- Air movers in the flight conveyor's throat and on top of the computer box
- Jib spray block
- Concave spade plate on the LHS of the road header spade
- Flight conveyor discharge cover (conveyor belt)
- 45° scrubber outlet deflector plate
- Water pressure of 15 to 20 bar
- Dust scrubber system.

Table 4.2.6 shows the dust-concentration levels at the intake, operator and return during the sampling period for the BDCS without the wet head.

**Table 4.2.6: Average dust-concentration levels for the BDCS without the wet head
(Test Week 4)**

Test No.	Sample Position			Road Header Section Details		
	Intake (mg/m ³)	Operator (mg/m ³)	Return (mg/m ³)	Road #	H or S	Production in tons
13	0,29	1,76	1,26	5	H	760
14	0,67	4,24	2,91	7	H	670
15	0,28	3,36	2,02	4,5,6,7,6	SR,SR,H	810
16	0,42	2,62	1,48	4,3,2	H, SL	800
17	0,43	5,56	3,36	5,6	SR	510

The calculated average dust-concentration levels (eight tests) at the operator's position and the section return during the sampling period were 3,51 mg/m³ and 2,21 mg/m³ respectively. Similarly, the determined TWA (8-h) dust-concentration levels at the operator and return positions were 2,54 mg/m³ and 1,58 mg/m³ respectively. In Appendix A (Figures A13 to A17), the real-time respirable dust-concentration level plots for Tests 13 to 17 are shown. However, in Test 17, poor section ventilation was observed due to the presence of a dyke in the section intake road and this required the ventilation layout of the section to be altered since most of the air was passing the previous split and thus short-circuiting the air to the return.

4.2.7 Observations and results from the System 1 evaluations

The box plots of the concentration levels at the section intake, RH operator's position and section return during the BCDS trials without the wet head are shown in Figures 4.2.7a, b and c respectively. The average coal production for the 17 production shifts was 840 tons/shift, with a maximum production of 1 680 tons. The average calculated dust-concentration levels at the intake, operator and return positions for the sampling period were 0,60 mg/m³, 4,88 mg/m³ and 3,19 mg/m³ respectively.

The plot in Figure 4.2.7b shows that there is an increase in the concentration level at the operator's position with an increase in production, but no conclusive relationship between increase in production and dust-concentration level could be derived. At the operator's position, during the highest production level of 1 680 tons, compliance with the requirement for

a dust concentration below 5,0 mg/m³ was not achieved. However, during Test 10, a few of the critical elements of the BCDS were not operational. Further, because various parameters could influence the dust-concentration levels, it is questionable whether the production level was the sole factor causing the failure of the dust-control system.

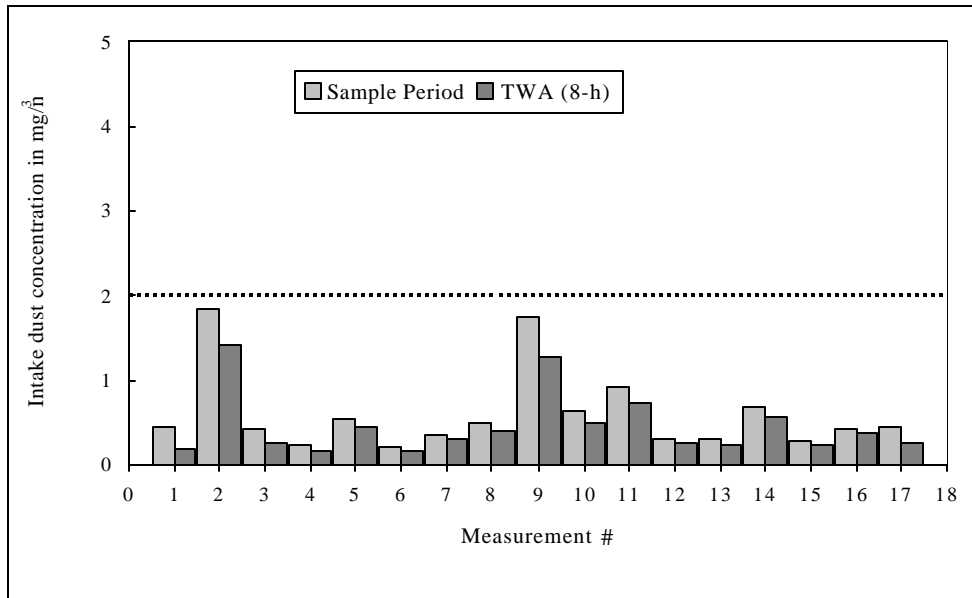

Figure 4.2.7a: Intake dust-concentration levels during the trials with the BCDS without the wet head

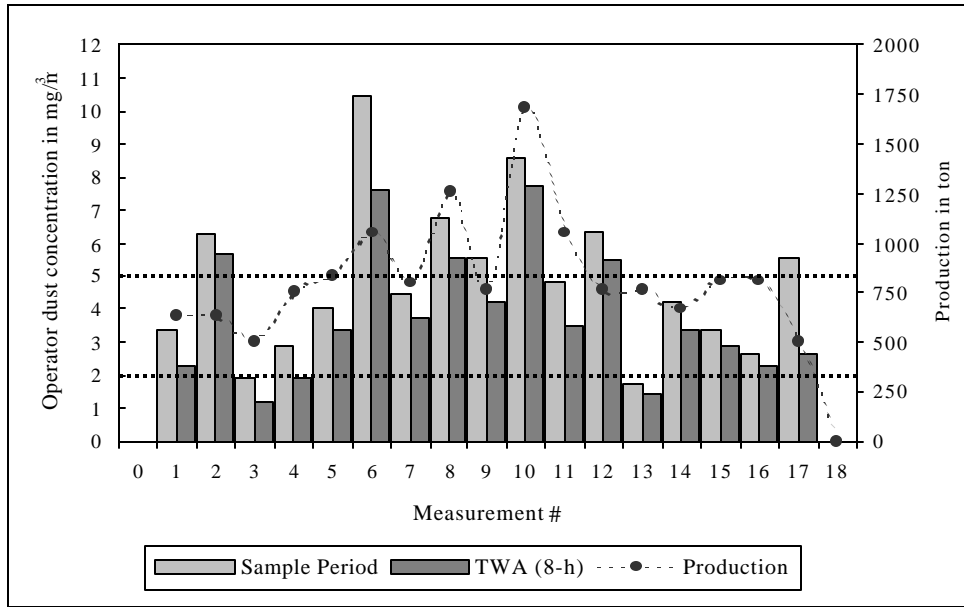

Figure 4.2.7b: Operator's dust-concentration levels during the trials of the BDCS without the wet head

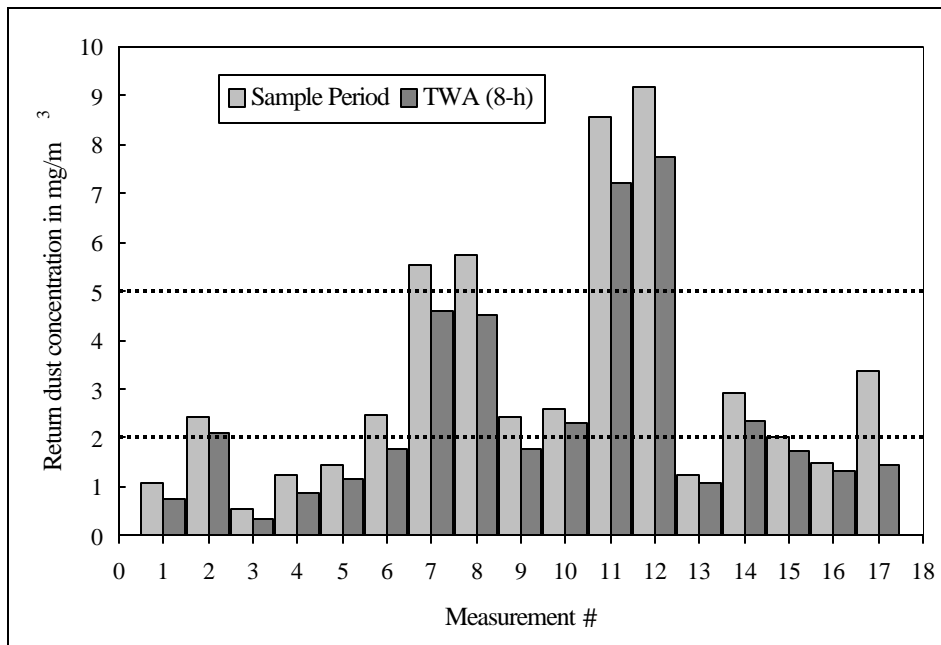

Figure 4.2.7c: Return dust-concentration levels during the trials of the BDCS without the wet head

Table 4.2.7a shows the summary statistics of the BDCS without the wet head. The calculated average dust-concentration levels (17 tests) at the section intake, operator and section return for the sampling period were 0,46 mg/m³, 3,82 mg/m³ and 2,53 mg/m³ respectively. The average sampling time for testing the entire system was 375 minutes.

During Tests 5, 8, 11 and 12, Section 13 was stone-dusted in between the shifts. Therefore, stone dust influenced the samples in the section return as well. For this reason, the section return dust-concentration readings for those specific shifts were removed for calculation purposes. The calculated average return dust-concentration levels during the tests with System 1 (12 tests) for the sampling period and the 8-h TWA were therefore 2,28 mg/m³ and 1,78 mg/m³ respectively.

Table 4.2.7a: Summary statistics of dust-concentration levels (8-h TWA) for the BDCS without the wet head

Sample	Sampling Position		
	Intake	Operator	Return
Mean, mg/m ³	0,458	3,824	2,533
Standard Deviation, mg/m ³	0,370	1,968	2,189
Variance, (mg/m ³) ²	0,137	3,876	4,794
Minimum, mg/m ³	0,147	1,224	0,364
Maximum, mg/m ³	1,420	7,726	7,722
Median, mg/m ³	0,297	3,383	1,780
Number of samples, N	17	17	17
1 st Quartile, mg/m ³	0,244	2,288	1,127
3 rd Quartile, mg/m ³	0,539	5,507	3,422

4.2.8 Discussion of critical issues from the System 1 tests

The following observations were made during the trials with the BDCS without the wet head:

- The BDCS without the wet head was able to control the dust adequately and to ventilate the face area of the heading effectively.

- In the absence of auxiliary ventilation devices such as a jet fan or force fan, beyond 20 m from the LTR, the on-board scrubber along with the sprays should not be allowed to stop in between the cutting periods as this could disrupt the smooth airflow across the face area.
- When the RH was cutting at a height of 5,5 m on the LHS, very high dust-concentration levels at the operator's cabin position were observed. This sometimes extended to the remote operator's position. The introduction of the concave spade plate greatly reduced this tendency. The concave spade plate contained the dust in the face area to a large extent and reduced the frequent rollback of dust. The jib spray block (B), augmented by the concave spade plate, suppressed the dust in the face area when the RH was cutting the top LHS of the face area.
- Similarly, the dust concentration peaked when the RH holed through splits and at the beginning of a fresh cut (heading or split) as the face environment is then not confined.
- In the initial tests (Tests 1 to 12), the deflector plates of the scrubber discharge were horizontal, thus blowing the discharge air over the RH flight conveyor and increasing recirculation of dust back to the operator's position.
- When the dovetail sprays are directed in line with the LHS of the RH cutting drum, they cover and capture more dust, and reduce rollback when the RH is cutting the roof.
- When the physical half-curtain is just inside the heading, dust rollback from the LHS is reduced dramatically. It was observed that when the RH boom was moving from right to left while cutting the top coal, the dust rollback towards the operator was at its highest.
- The maximum rollback towards the operator occurs when the RH sumps and cuts from the RHS to the LHS at the top of the face. This results in increased dust rollback at the bottom LHS of the operator.
- Even when there was no auxiliary ventilation (jet fan or force fan) in the deep heading, the operator's side was well ventilated when the shuttle car was waiting to load the coal in the heading behind the RH. However, auxiliary ventilation with a column is recommended for use underground and due consideration must be given to this in the case of high-methane-content coal seams.
- The effectiveness of the concave spade plate was visible, as the dust is deposited on the concave side of the spade plate where it is suppressed by the water sprays positioned on the LHS of the jib. It is hoped that a concave spade plate on both sides of the RH spade may prove to work even better, preventing the dust from escaping towards the section

return.

- From the underground observations, the general quality of the spray nozzles appeared to be quite variable, particularly with respect to the final orifice hole that was drilled into the thin sheet-metal plate. Visual inspection of a number of nozzles revealed a range of problems, including angled drilling of the holes, elliptical orifices and the presence of burrs. The observable effects of such problems include incorrectly aligned sprays, gaps in spray coverage and a generally 'streaky' appearance to the spray.

4.3 Underground test dust results: System 2 - BDCS with wet head

4.3.1 System 2 components

A total of eight tests were carried out using the BDCS with the wet head. For Tests 18 to 25, the following elements of the dust-control system were operational:

- Hollow-cone single-inlet spray nozzles (1,6 mm (inlet) / 2,0 mm (outlet))
- Physical half-curtain
- Air movers on the flight conveyor and on top of the computer box (LHS of the operator)
- Jib spray block
- Concave spade plate on the LHS of the road header
- Flight conveyor discharge cover (conveyor belt)
- 45° scrubber outlet deflector plate
- Water pressure of 15 to 20 bar
- Dust scrubber system.

In order to balance the water flow rates of approximately 60 L/min to the wet head and approximately 3,0 L/min/nozzle to the external spray system, a few of the spray blocks were disconnected and a few nozzles of the following spray blocks were blocked (Figure 3.3):

- Two spray blocks on the scrubber side (J and K) – 6 nozzles were blocked
- Centre nozzle of the spray blocks (B, C, D, H, I) – 6 nozzles were blocked
- Alternate nozzles of the head spray blocks (E, F, G) – 4 nozzles were blocked.

In all, a total of 16 nozzles (6 + 6 + 4) were blocked out of the initial 38 nozzles in order to balance the flow rate of approximately 60 L/min to the wet head and to the 22 external sprays in the optimum spray configuration (seven air movers included). This means that 42% of the sprays (excluding the seven air movers) were blocked to allow the wet head to operate effectively.

4.3.2 Observations and results from the System 2 evaluations

Table 4.3.2a shows the dust-concentration levels at the intake, operator and return during the sampling period for the BDCS with wet head. The calculated average dust-concentration levels (eight tests) at the section intake, operator's position and section return during the sampling period were 0,96 mg/m³, 3,75 mg/m³ and 2,33 mg/m³ respectively. The average sampling time for the entire test system was 340 minutes. Similarly, the calculated TWA (8-h) dust-concentration levels at the intake, operator and return positions were 0,73 mg/m³, 2,69 mg/m³ and 2,33 mg/m³ respectively. In Appendix A, the real-time respirable dust-concentration level plots for Tests 17 to 25 are shown.

Table 4.3.2a: Average dust-concentration levels in mg/m³ for the BDCS with the wet head

Test No.	Sample Position			Road Header Section Details		
	Intake (mg/m ³)	Operator (mg/m ³)	Return (mg/m ³)	Road #	H or S	Production in tons
18	0,25	4,95	3,55	5	H	960
19	1,46	3,35	2,26	7,8	SR	590
20	1,15	4,37	3,38	3,2,2,1	SL,SL	300
21	0,23	2,06	1,56	5,6,6,7	SR,SR	590
22	0,15	2,75	2,54	6	H	840
23	3,75	7,48	3,23	7	H	630
24	0,40	0,68	0,49	4	H	85
25	0,29	4,38	1,61	2,1	SL	580

Table 4.3.2b shows the summary statistics of the dust-concentration levels (8-h TWA) for the BDCS with the wet head. The average coal production for the eight production shifts was 570

tons, with a maximum production of 960 tons. The box plots of the concentration levels at the section intake, RH operator's position and section return during the BDCS trials with the wet head are shown in Figures 4.3.2a, b and c respectively.

Table 4.3.2b: Summary statistics of dust-concentration levels (8-h TWA) for the BDCS with the wet head

Sample	Sampling Position		
	Intake	Operator	Return
Mean, mg/m ³	0,732	2,690	1,656
Standard Deviation, mg/m ³	1,071	1,733	0,783
Variance, (mg/m ³) ²	1,148	3,006	0,613
Minimum, mg/m ³	0,124	0,372	0,269
Maximum, mg/m ³	3,253	6,438	2,775
Median, mg/m ³	0,210	2,386	1,688
Number of samples, N	8	8	8
1 st Quartile, mg/m ³	0,170	1,854	1,127
3 rd Quartile, mg/m ³	0,977	3,086	2,268

The plot in Figure 4.3.2b shows that there is no clear relationship between the production level and an increase in the dust-concentration level at the operator's position. At the operator's position, during the highest production level of 960 tons, compliance with the requirement for below 5,0 mg/m³ was achieved.

It is further noted that the average intake dust concentration during the BDCS tests without the wet head was 58% higher than the average intake dust concentration during the tests *with* the wet head system. Also, the results of the only non-compliance test (Test 23) could be attributed to a very high intake dust-concentration level of 3,75 mg/m³.

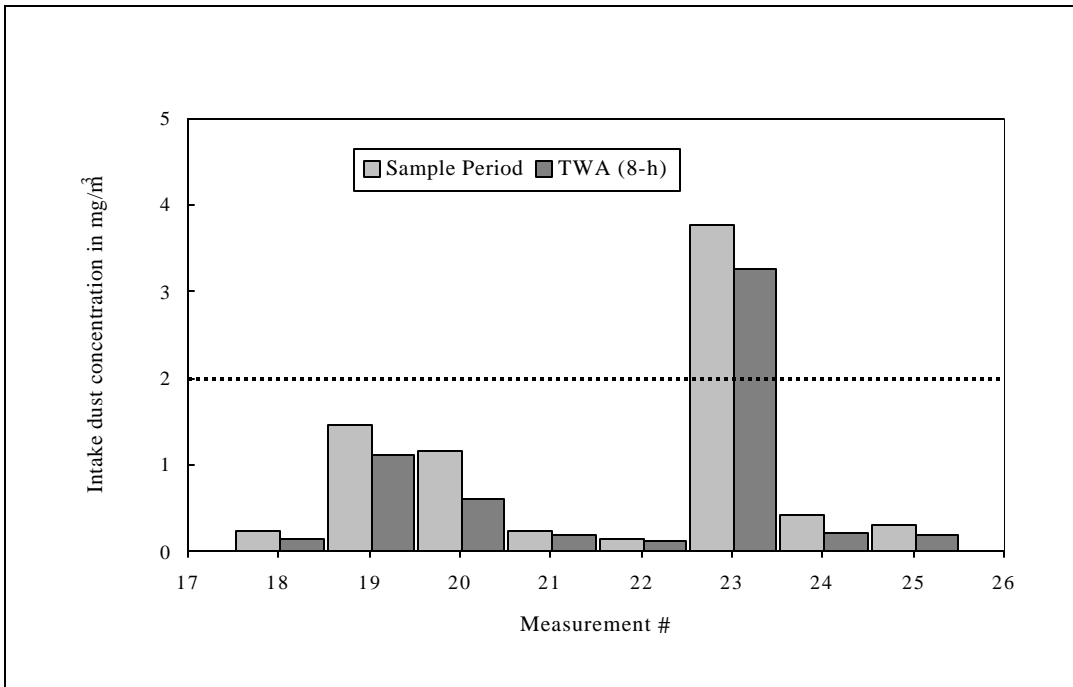

Figure 4.3.2a: Intake dust-concentration levels during the trials of the BDCS with the wet head

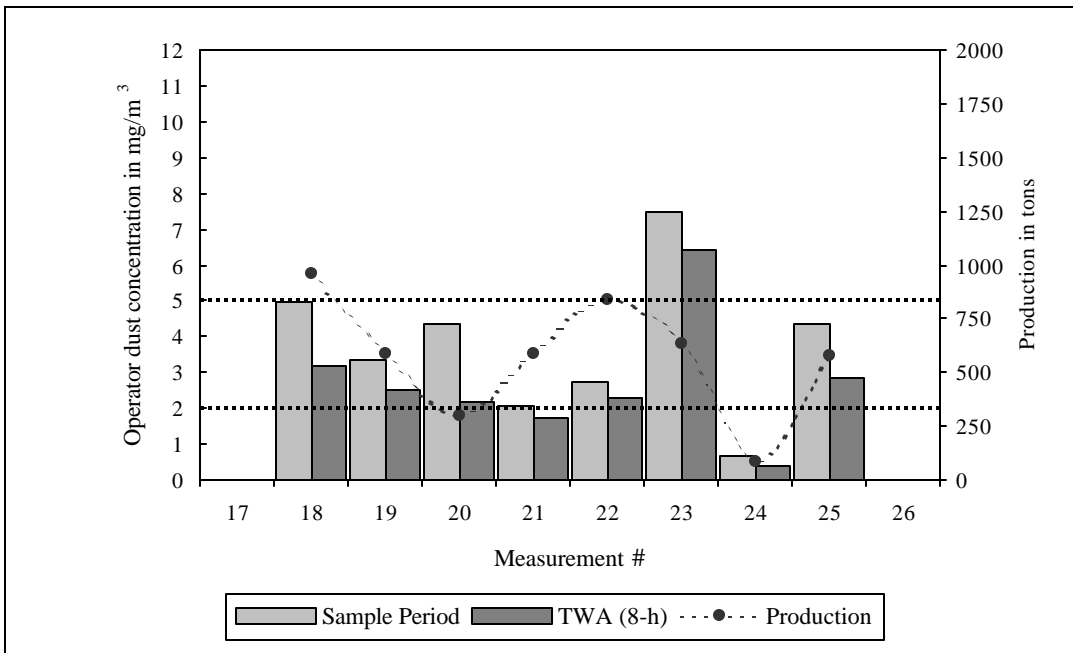

Figure 4.3.2b: Operator's dust-concentration levels during the trials of the BDCS with the wet head

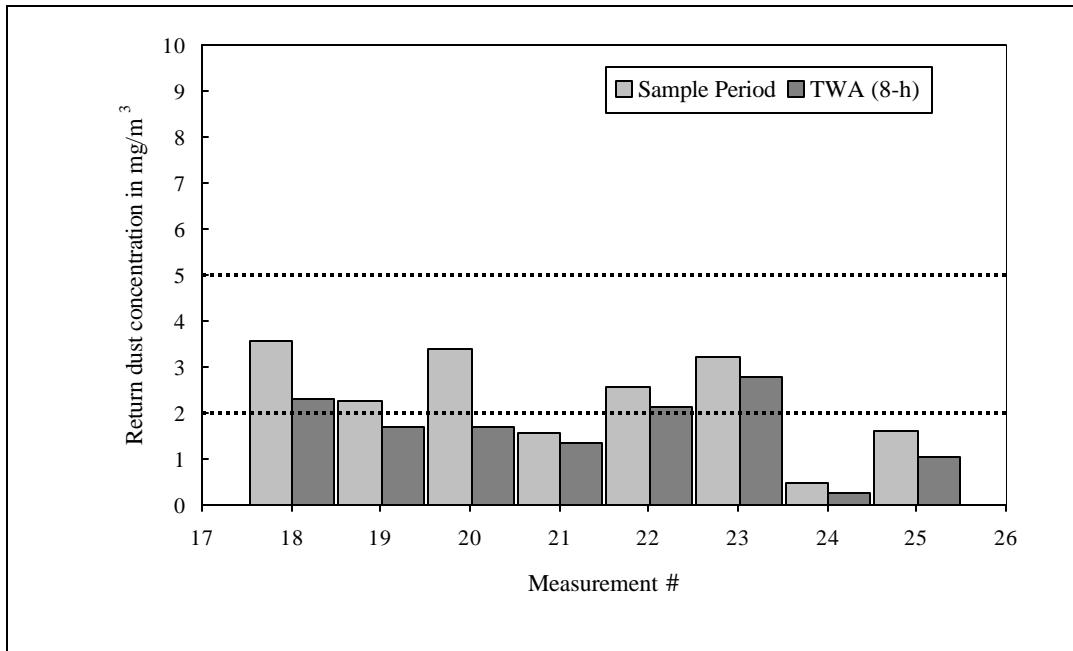

Figure 4.3.2c: Return dust-concentration levels during the trials of the BDCS with the wet head

4.3.3 Discussion of critical issues from the System 2 tests

- It was visually observed that the concave plate contained the dust at the face.
- Visual observations showed that the absence of the scrubber side sprays enabled dust to escape towards the scrubber return.
- During the tests, a dyke was present in the section, resulting in a change in the airflow pattern in the LTR. Thus it could not be clearly determined whether the wet-head system was effective, although the operator's dust concentration was below the legal limits.
- However, the real-time dust results in the return show a trend towards higher levels of dust escaping towards the return from the face (Figures A18 to A25 in Appendix A).
- Also, from the underground observations, as for the system tests, the general quality of the spray nozzles appeared to be quite variable, particularly with respect to the final orifice hole that was drilled into the thin sheet-metal plate. Visual inspection of a number of nozzles revealed a range of problems, including angled drilling of the holes, elliptical orifices and the presence of burrs. The observable effects of such problems include incorrectly aligned sprays, gaps in spray coverage and a generally 'streaky' appearance to the spray.

4.4 Underground test methane results

4.4.1 General methane conditions encountered

A total of 18 shifts were monitored during the test series. For all the tests the maximum methane levels did not exceed 0,3% methane in air by volume, with an average of below 0,1% methane by volume recorded. No discernable difference in gas levels was observed between cutting with the BDCS with and without the wet head. The impact that the changes made to the on-board dust-control system had on the methane control around the machine could not be quantitatively ascertained due to the low levels recorded.

However, it has to be noted that the peak gas levels were recorded when mining was taking place near a dyke, where increased gas levels are usually expected. During the tests, an average level of 0,1% methane by volume was encountered, which is more representative of the general methane conditions.

4.4.2 In-heading gas release rate

During the test series, the in-heading gas release rate for three samples was determined to verify the recorded low methane levels. This rate was determined by using the standard direct test method for determining the gas content of coal. The calculated gas release rate while the cut coal is in the heading is used as an indicator of the gas released in the heading during cutting. The gas desorbed from the coal before measuring commences (i.e. the gas released in the heading) is determined by using the square root of time method for the standard direct test method. The results of the two tests are shown in Table 4.4.2. Test 1 was done during the cutting of a split, when the coal had had time to desorb the gas. Test 2 was carried while the RH was cutting a straight at a depth of 21 m from the LTR.

Table 4.4.2: In-heading gas release rate of test section

Sample #	In-heading gas release rate (L/ton/min)	Gas released in-heading per minute at cutting rate of 7 tons/min
1	Non-detectable	N/A

2	16	112
---	----	-----

The in-heading gas release rate was below the national average of 80 L/min. Taking into consideration the in-heading air volume available for gas dilution and the cutting action of the jib, the low methane levels recorded were not unexpected.

4.4.3 Comments on methane monitoring

Due to the low in-heading gas release rates and the large area available for methane dilution around the jib, the generally low methane levels recorded around the RH could be expected. Because of the low methane levels recorded (below the accuracy levels for pellistor-type sensors), it was difficult to determine whether distinct changes in the methane gas behaviour occur when changes are made to the on-board dust-control system. The low gas levels also made it difficult to detect whether a gas build-up can occur and, if so, what in-heading gas release rates would cause such a situation. From the available data, this scenario appeared unlikely for both the dust-control systems tested. It is, however, clear that for the test conditions, the methane hazard is well under control, with peak levels never exceeding 0,3% methane in air by volume, which is well below the maximum permitted concentration of 1,4% methane per volume.

5 Conclusions

The OSS configuration evaluated in the surface trials was found not to be effective underground in controlling the dust at the operator's position. Several additional components/modifications were therefore incorporated into the OSS. With the addition of these components, it can be claimed that several systems were evaluated during the test period. In summary, the systems evaluated underground were:

- System 1: Bank 2000 RH Dust Control System without the wet head
- System 2: Bank 2000 RH Dust Control System with the wet head

The results obtained during the trials of the systems at Bank Colliery, South Shaft, were encouraging, with both the systems constantly keeping the dust-concentration levels within

the 5 mg/m³ design criterion. The results of the average dust-concentration levels at the RH operator's position for the two systems tested are shown below:

Table 5: Summary of systems modification tests

Test System	No. of Tests	Sampling Period Average (mg/m³)	TWA-CONC (8-h) (mg/m³)
System 1-1	4	3,63	2,78
System 1-2	4	6,42	5,06
System 1-3	4	6,33	5,24
System 1-4	5	3,51	2,54
Total System 1	17	4,88	3,82
Total System 2	8	3,75	2,69

5.1 System 1: BDCS without the wet head

The dust-concentration results for this system can be summarised as follows:

- Sampling period average = 4,88 mg/m³
- TWA (8-h) = 3,82 mg/m³

The following conclusions were drawn from the data:

- The BDCS without a wet head is able to effectively control the dust in a heading and ventilate the face area of the heading.
- With the BDCS without a wet head fully operational, i.e. all the elements operating within specification, an 8-h TWA dust-concentration at the operator's position of 2,54 mg/m³ was recorded.
- In the absence of auxiliary ventilation devices such as a jet fan or force fans, the on-board scrubber and water spray system should not be switched off if the RH is deeper than 20 m into the heading.
- When the RH is cutting top coal on the LHS of the heading at a height of 5,5 m, recurrent very high dust-concentration levels at the operator's cabin position are observed. These high concentrations sometimes extend to the remote operator's position. The introduction of the combination of a concave spade plate on the LHS of the RH, an air mover mounted on the computer box and jib sprays greatly reduces this trend. It is expected that introducing a concave spade plate on the RHS of the RH will further reduce the dust introduced into the LTR of the section.

- Dust concentrations peak when the RH holes through a split, and at the beginning of a cut (heading or split).
- Even with no auxiliary ventilation in deep headings (> 20 m) and when a shuttle car is in the heading, the operator's side of the RH is well ventilated.
- During the test, methane levels never exceeded 0,3% VV, which is well below the regulatory level of 1,4% VV. It was thought that the seam gas content of the seam being mined must be very low. Mine environmental personnel confirmed this. Due to the low levels of methane recorded (below the accuracy levels for pellistor-type sensors), it is difficult to comment on the effect the BDCS has on methane dilution in a heading.
- If high levels of methane are encountered, it is recommended that the use of auxiliary ventilation equipment be considered.

5.2 System 2: BDCS with the wet head

The dust-concentration results for this system can be summarised as follows:

- Sampling period average = 3,75 mg/m³
- TWA (8-h) = 2,69 mg/m³

The following conclusions were drawn from the data:

- The BDCS with the wet head is able to effectively control the dust in a heading and ventilate the face area of the heading.
- As without the wet head, it was found that in the absence of auxiliary ventilation devices such as a jet fan or force fans, the on-board scrubber and water spray system should not be switched off if the RH is deeper than 20 m into the heading.
- It was found that the introduction of the wet head did not have any significant effect on the dust generation in the section when the RH is cutting top coal on the LHS of the heading at a height of 5,5 m.
- The dust-concentration peaks were still found to be highest when the RH holes through a split and at the beginning of a cut (heading or split).
- No significant changes were observed with the addition of the wet head with regard to the ventilation of the heading at depths of > 20 m in the absence of auxiliary ventilation equipment. The operator's side was still well ventilated, even when the shuttle car was being loaded.
- For the test conditions with the wet head operational, the methane levels were still under 0,3% VV. The seam gas conditions in the section were still low, making it very difficult to quantitatively assess the impact that the addition of the wet head has on in-heading

methane control.

- If high levels of methane are encountered, it is still recommended that the use of auxiliary ventilation equipment be considered.

5.3 General conclusions

- Due to the limitations in the test conditions, no direct comparisons could be made with regard to the performance of the BDCS with and without a wet-head system.
- From the underground observations, the general quality of the spray nozzles appeared to be variable, particularly with respect to the final orifice hole that was drilled into the thin sheet-metal plate. Visual inspection of a number of nozzles revealed a range of problems, including angled drilling of the holes, elliptical orifices and the presence of burrs. The observable effects of such problems include incorrectly aligned sprays, gaps in spray coverage and a generally 'streaky' appearance to the spray. It is very important that dust-control equipment manufacturers exercise good control over the components that they manufacture as this can have a significant effect on dust-control measures.
- It is extremely important that the BDCS components and design spray configuration be properly applied and regularly maintained in order to keep the dust concentrations below the legal limits.

6 Recommendations

To achieve a dust-concentration level of less than 5 mg/m³ at the operator's position, the recommended good practices to be followed are:

1. Implement the BDCS design and spray configuration correctly, and maintain the individual components regularly. Failure to do this will result in dust concentrations above the legal limit.
2. Adhere to the system design specifications, i.e. recommended water flow rates, recommended water pressure to the sprays and correct spray types.
3. Adhere to a minimum air velocity of 1 m/s in the LTR.

The following recommendations are made for future research based on the results obtained during the tests conducted at Bank Colliery, South Shaft, on the BDCS:

1. Several additional changes could be made that may enhance the environmental conditions in the RH sections, i.e.
 - a. The addition of a spray block on the top of the concave spade plate
 - b. The use of a concave spade plate on both sides of the RH
 - c. The use of a twin-inlet scrubber with inlets located on the LHS and RHS of the scrubber
 - d. The use of a small fan on the LHS of the operator's position to blow the dust towards the face.
2. The improved system should be evaluated, independently, so as to ensure compliance with the required 5 mg/m^3 sample dust concentration at the operator, and less than 1,4% methane per volume.
3. Due to the limitations in the test conditions and equipment availability (operational wet head), no comparison could be made between a system operating with a wet head and a system without a wet head. It has to be kept in mind that both systems utilise the same amount of water, which means that a system using a wet head has less water for its dust-control sprays. Considering the potential of a wet head for reducing dust generation and the added benefits of pick cooling, it is of the utmost importance that these two systems be compared. It is strongly recommended that such tests be carried out when a site becomes available (completion of the proposed SIMRAC project COL 603 extension).
4. It is critically important to evaluate the performance of the systems in high-methane-content seams to ensure adequate methane dilution and effective ventilation across the face.
5. There appears to be concern about the effectiveness of the various dust-control systems that have been developed over the past two years with regard to production rates in different coal seams. To date, no evidence-based relationships could be determined between an increase in production levels and an increase in the dust-concentration levels and the associated performance of dust-control systems.
6. Recent studies carried out in the USA by the NIOSH showed that there is a potential relationship between coal rank and dust-generation potential. Determination of the propensity of various coal seams towards dust generation could therefore enable both the potential exposure levels and required dust-control measures to be predicted more

closely.

7. Due to the dynamic nature of mining and the complex interaction between methane, dust and air, it is proposed that the BDCS be tested under low-seam mining conditions.
8. The directive on collecting dust samples at the operator's position and on dust monitoring should be revisited to incorporate the findings of recently completed SIMRAC projects, and to incorporate international trends.

7 References

Belle, B.K. and Du Plessis, J.J.L., 1998, "Summary Report on Mechanical Miner Environmental Control", SIMRAC Report, ESH 98-0249, South Africa.

Hole, B.J. and Belle, B.K., 1999, "Literature Review on Road Heading Machine Environmental Control", SIMRAC Interim Report: Phase 1, COL 603 (ESH 99-0330), South Africa.

Hole, B.J., 2000, "Surface Gallery Trials Related to Road Heading Machine Environmental Control", SIMRAC Interim Report: Phase 2, COL 603 (ESH 00-0170), South Africa.

South Africa, "Mine Health and Safety Act", 1996.

South African Department of Minerals and Energy, 1994, "Guidelines for the Gravimetric Sampling of Airborne Particulates for Risk Assessment in Terms of the Occupational Diseases in the Mines and Works Act No. 78 of 1973", DME Parent Document, South Africa.

South African Department of Minerals and Energy, 1997, "Directive", South Africa.

Van Zyl, F.J., 2000, Personal Communications, CSIR Miningtek, South Africa.

Appendix A

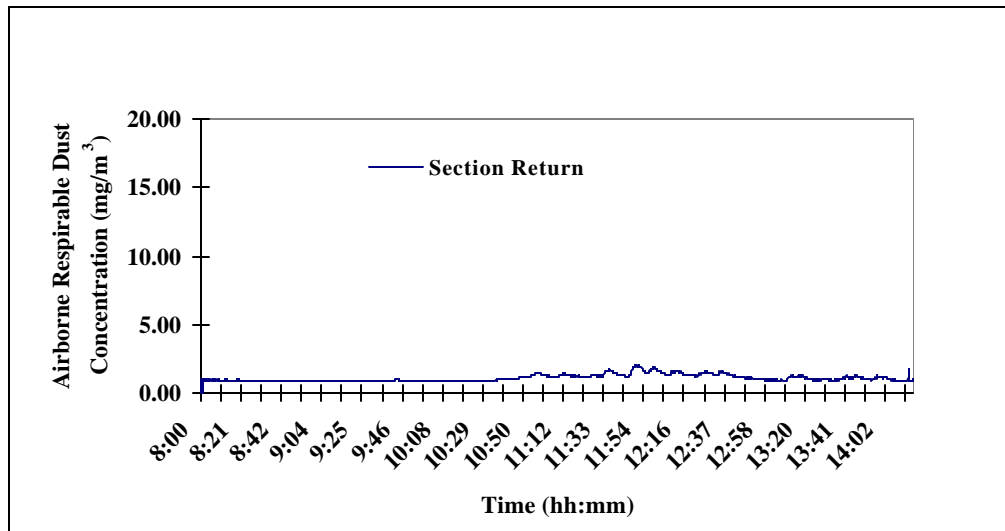
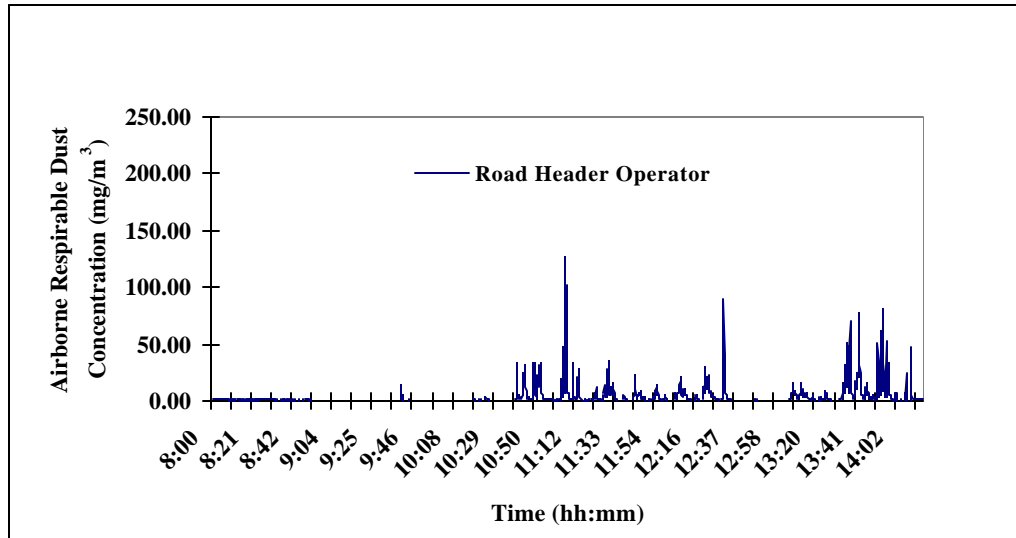

Figure A1: ARD concentration profile recorded by the real-time dust monitor (Hund Tyndallometer) at the road header operator and section return positions for Test # 1

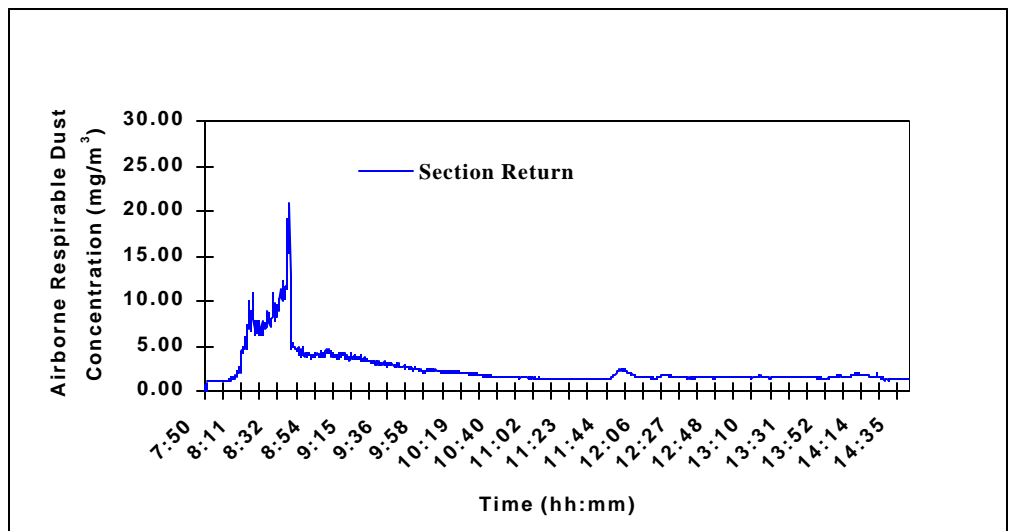
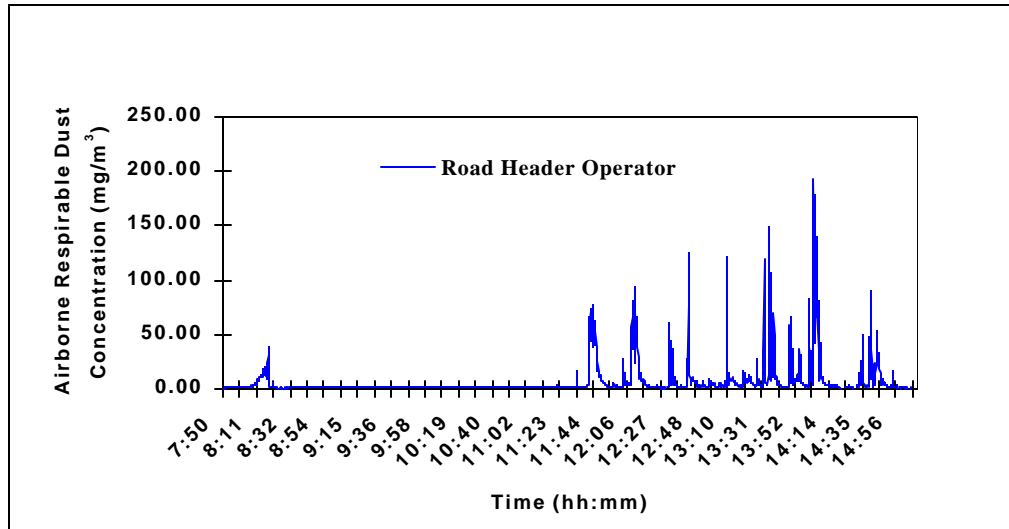

Figure A2: ARD concentration profile recorded by the real-time dust monitor (Hund Tyndallometer) at the road header operator and section return positions for Test # 2

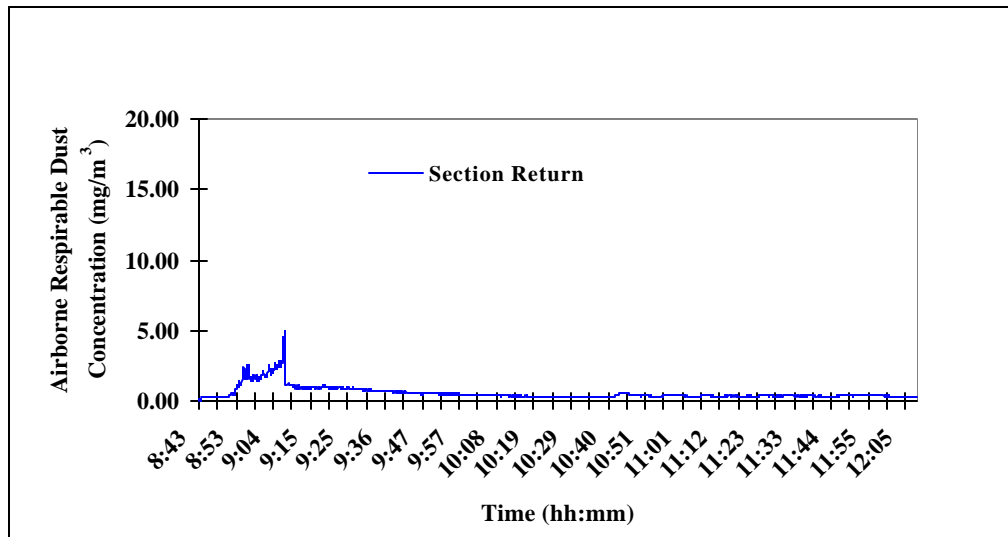
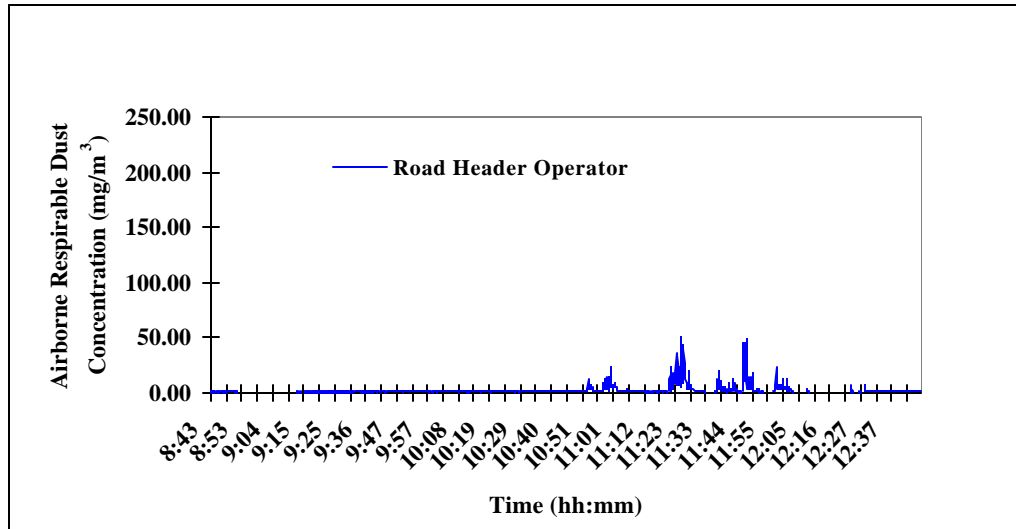

Figure A3: ARD concentration profile recorded by the real-time dust monitor (Hund Tyndallometer) at the road header operator and section return positions for Test # 3

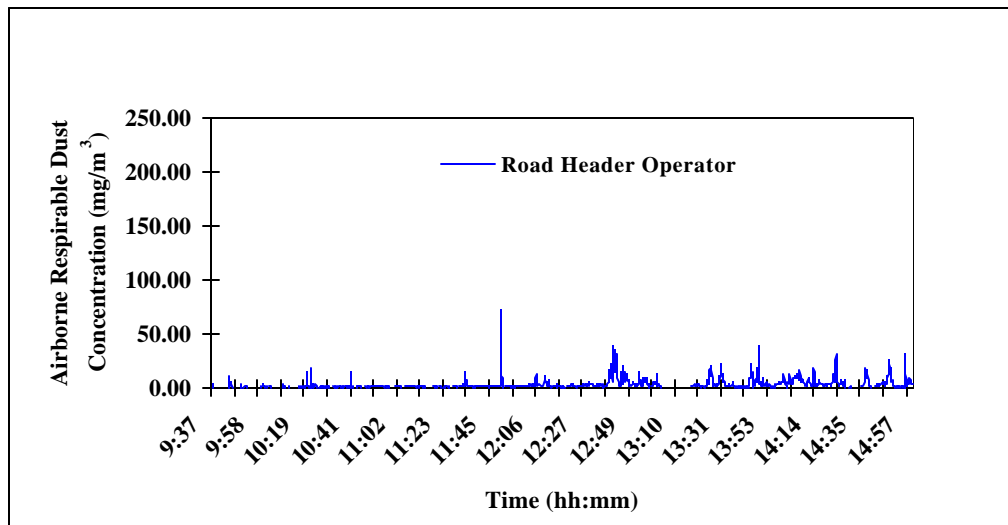
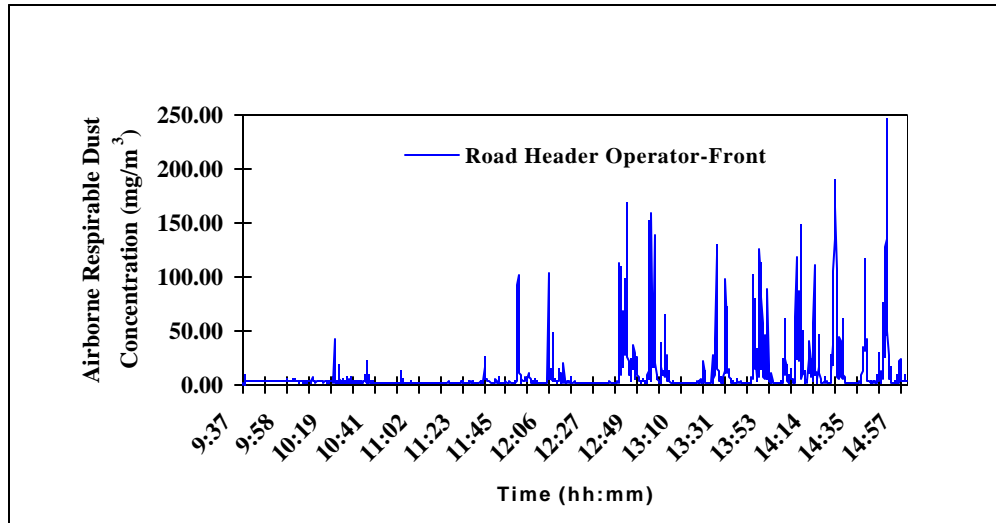

Figure A4: ARD concentration profile recorded by the real-time dust monitor (Hund Tyndallometer) at the road header operator positions for Test # 4

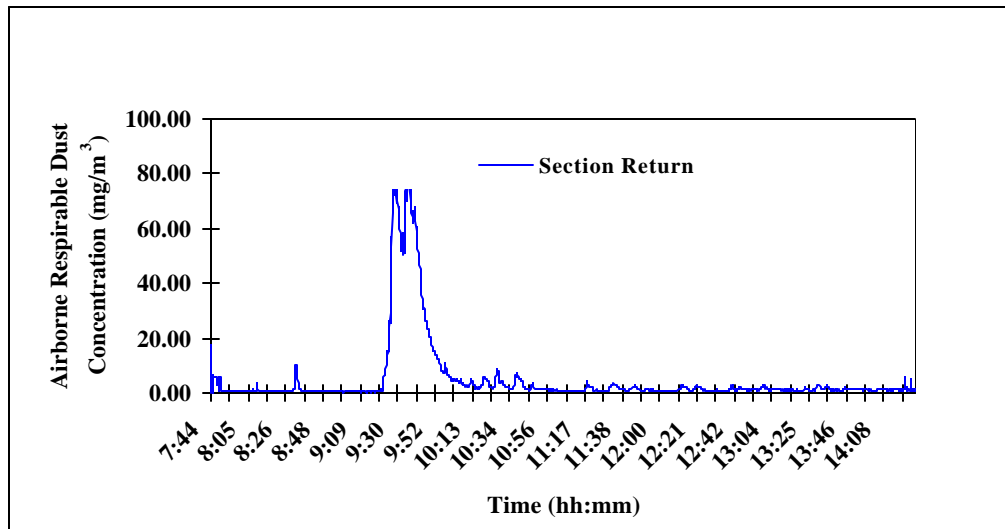
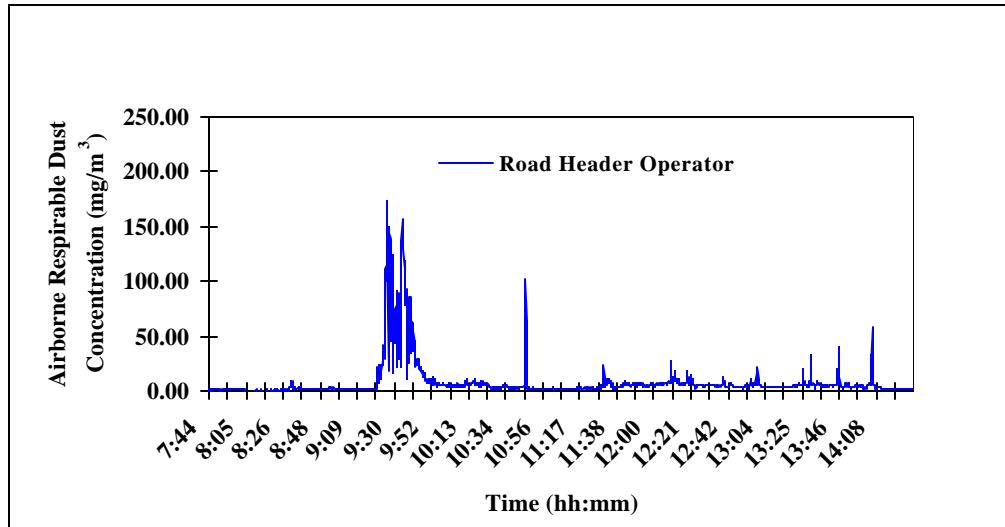

Figure A5: ARD concentration profile recorded by the real-time dust monitor (Hund Tyndallometer) at the road header operator and section return positions for Test # 5

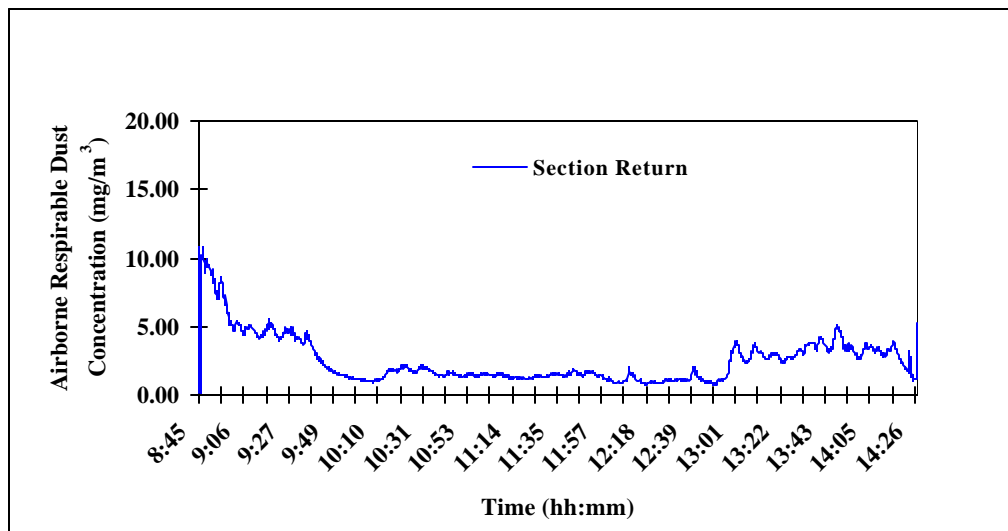
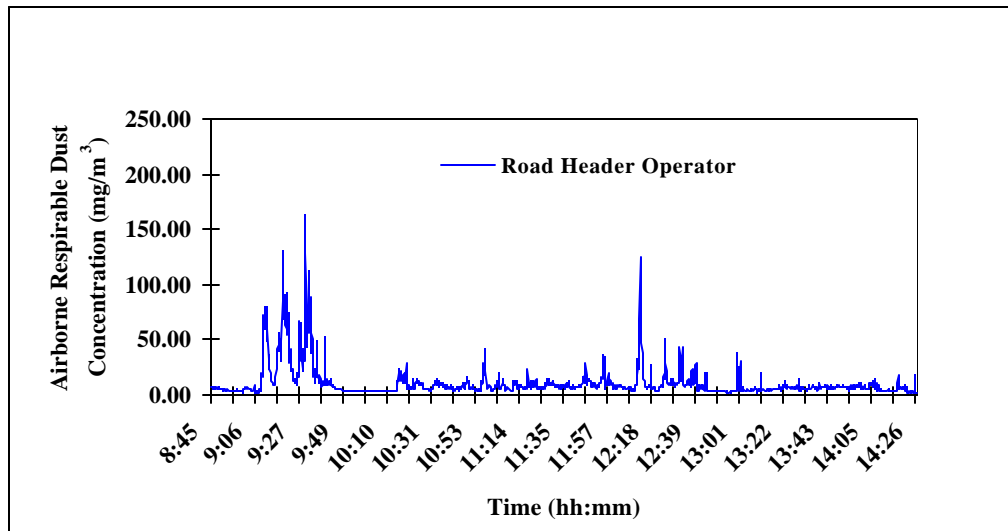

Figure A6: ARD concentration profile recorded by the real-time dust monitor (Hund Tyndallometer) at the road header operator and section return positions for Test # 6

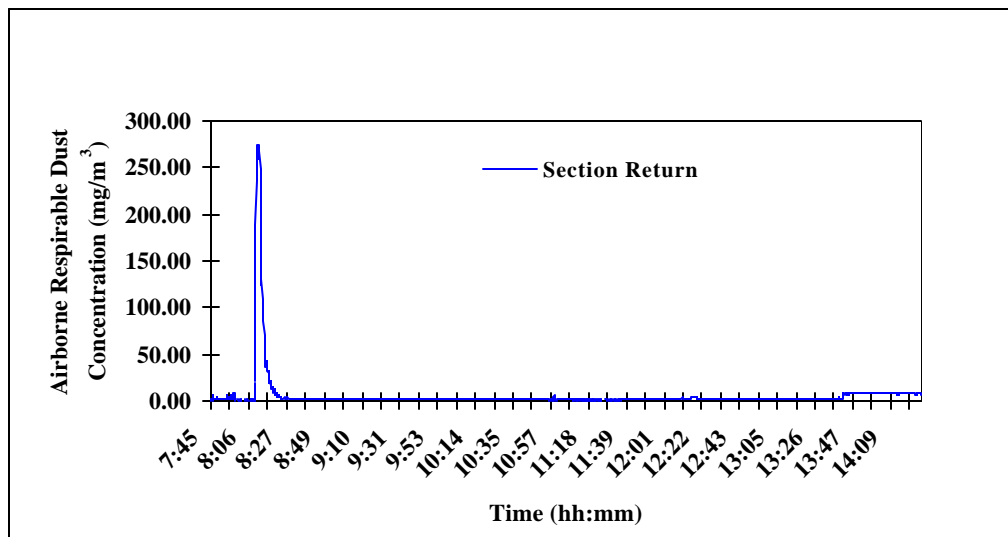
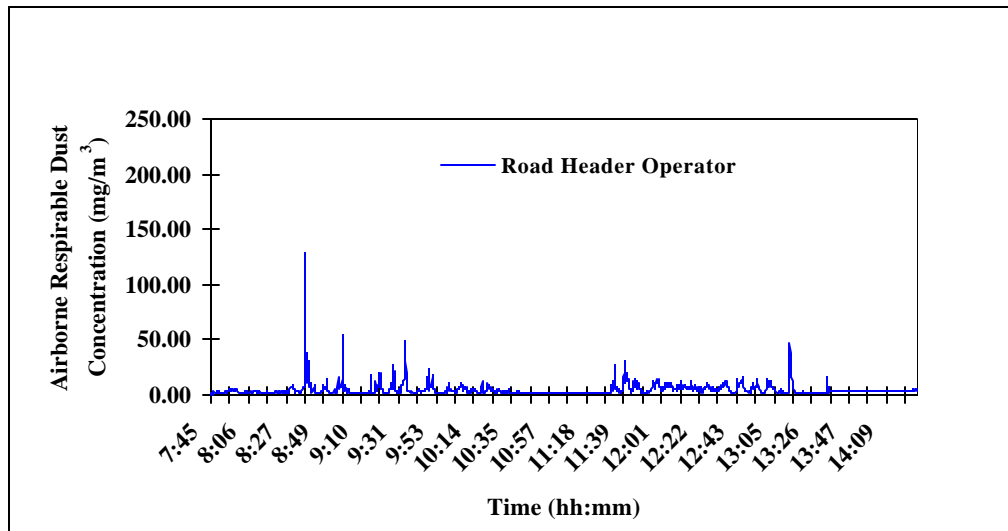

Figure A7: ARD concentration profile recorded by the real-time dust monitor (Hund Tyndallometer) at the road header operator and section return positions for Test # 7

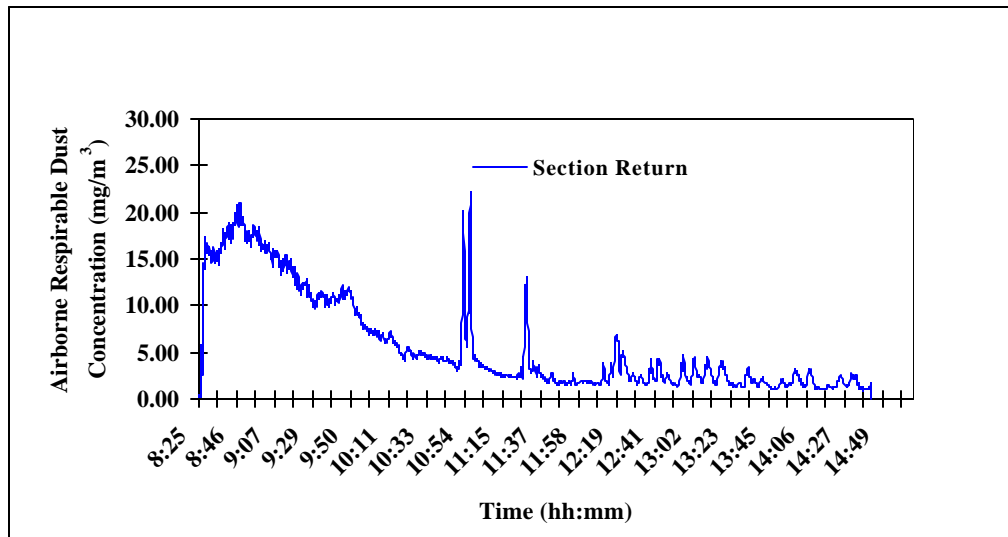
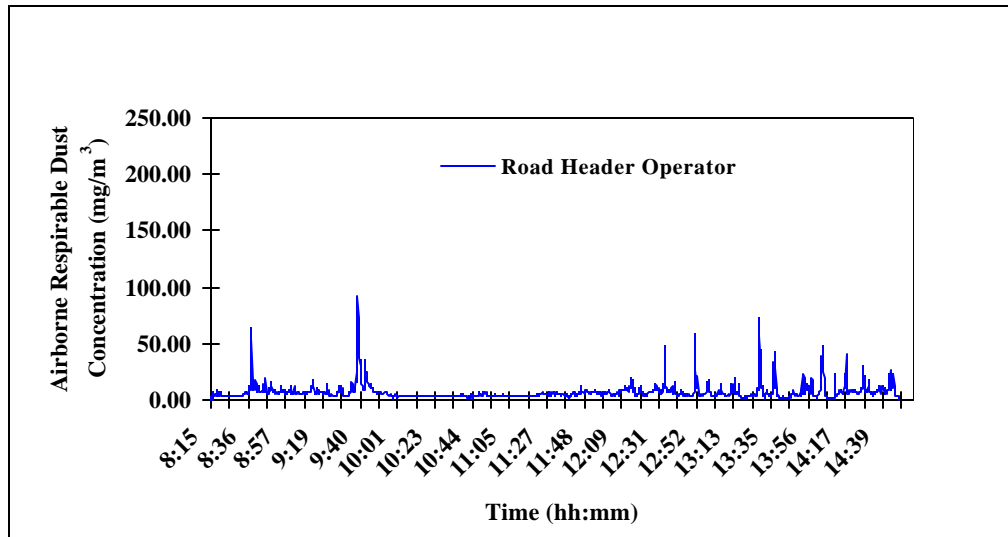

Figure A8: ARD concentration profile recorded by the real-time dust monitor (Hund Tyndallometer) at the road header operator and section return positions for Test # 8

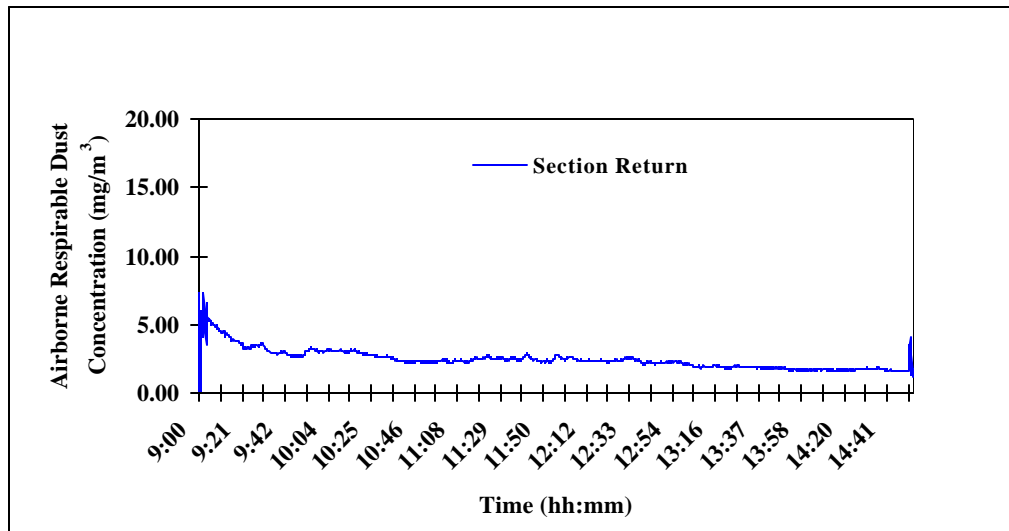
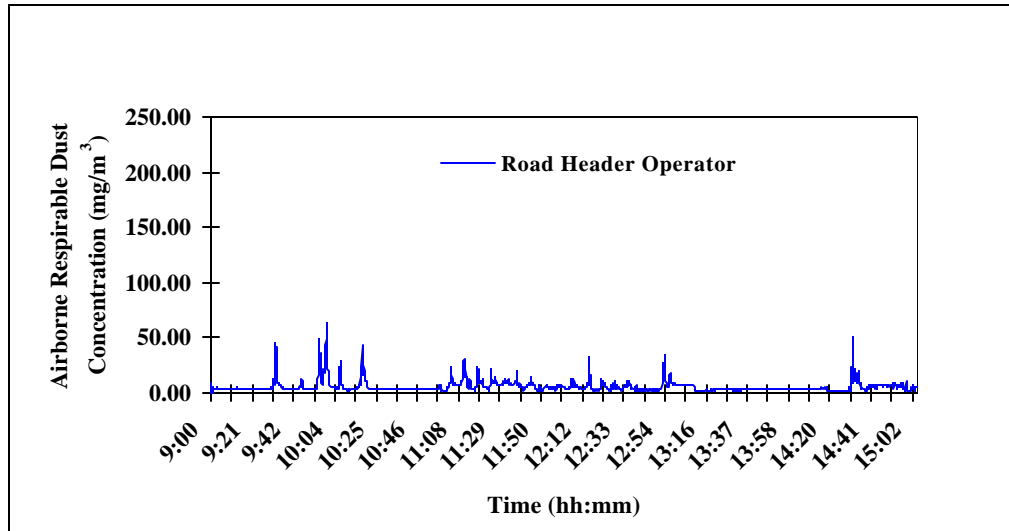

Figure A9: ARD concentration profile recorded by the real-time dust monitor (Hund Tyndallometer) at the road header operator and section return positions for Test # 9

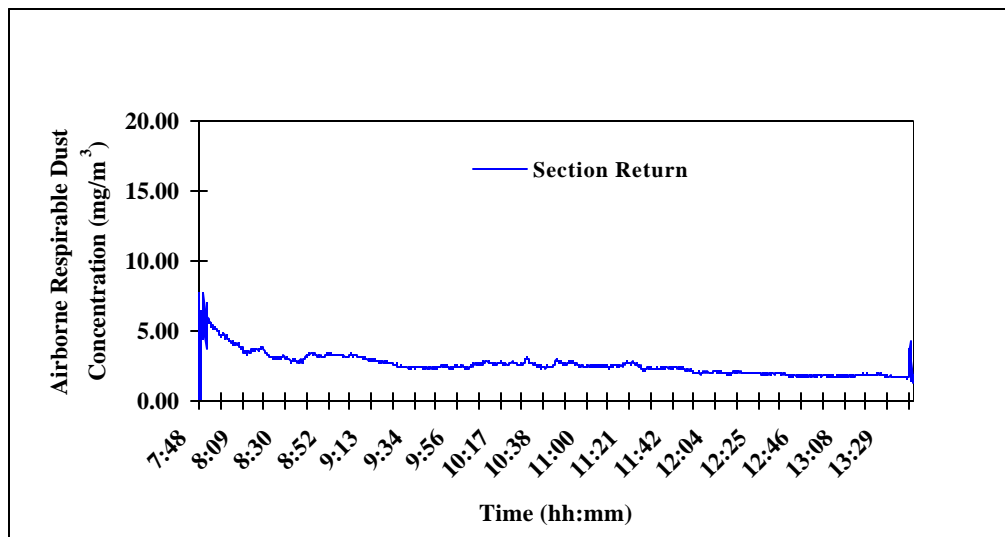
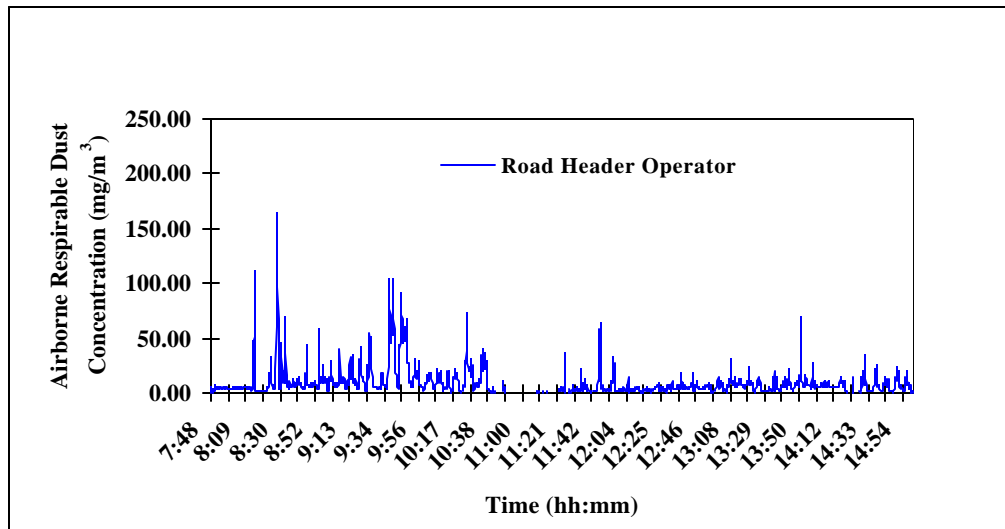

Figure A10: ARD concentration profile recorded by the real-time dust monitor (Hund Tyndallometer) at the road header operator and section return positions for Test # 10

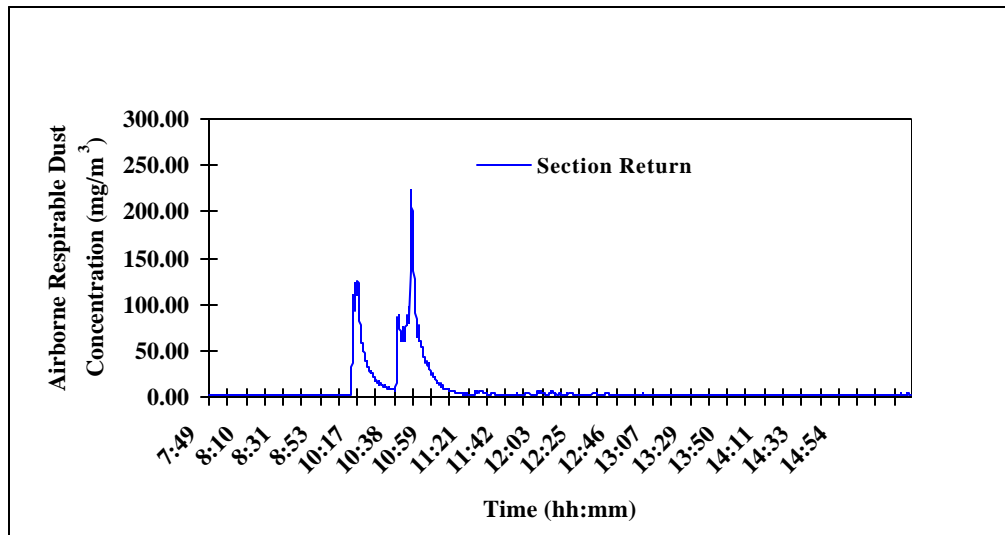
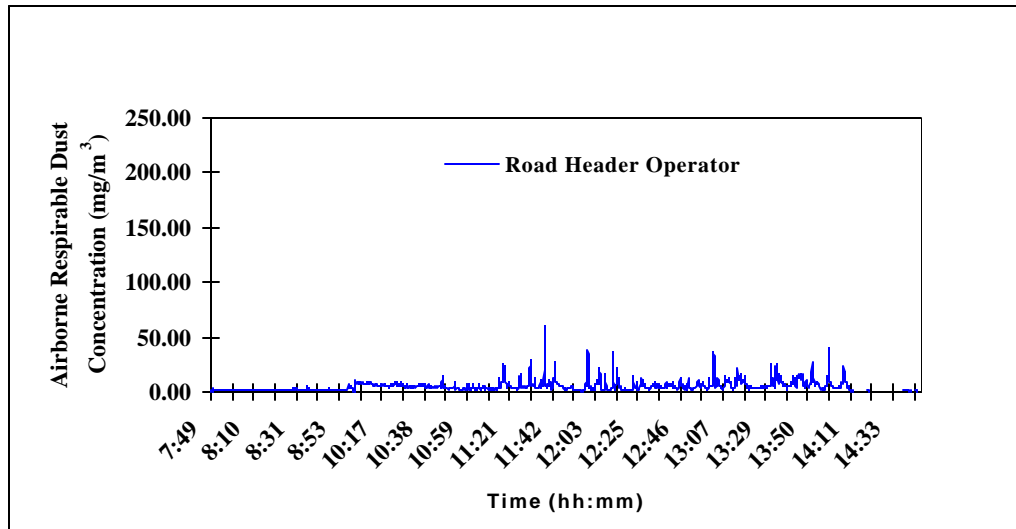

Figure A11: ARD concentration profile recorded by the real-time dust monitor (Hund Tyndallometer) at the road header operator and section return positions for Test # 11

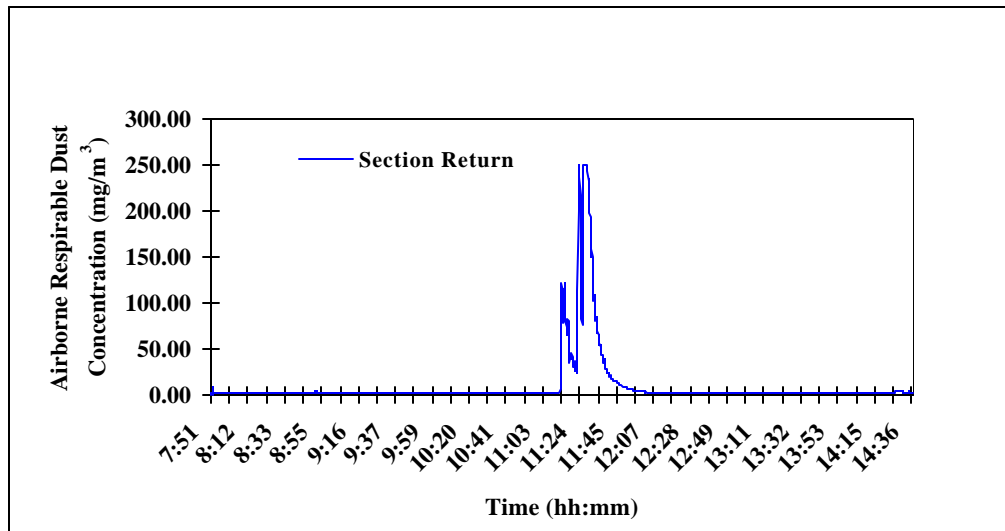
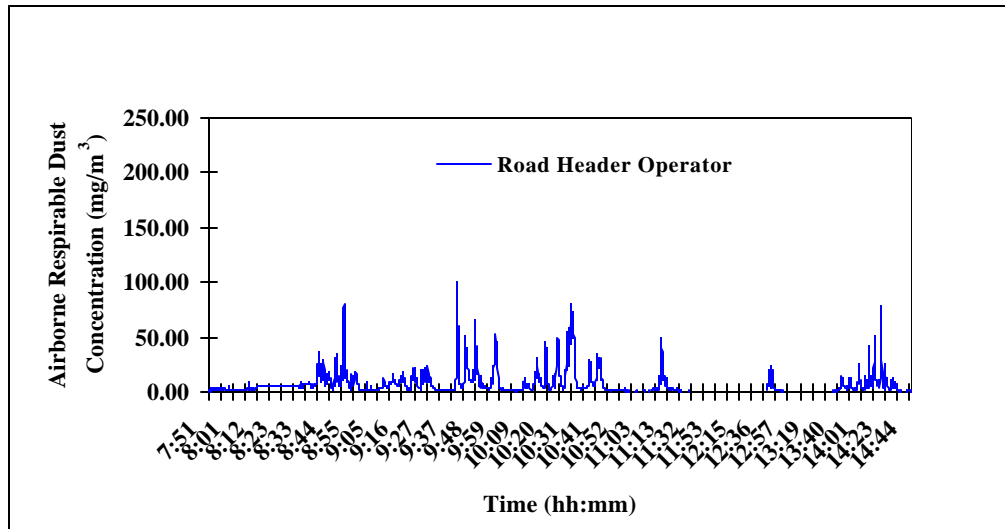

Figure A12: ARD concentration profile recorded by the real-time dust monitor (Hund Tyndallometer) at the road header operator and section return positions for Test # 12

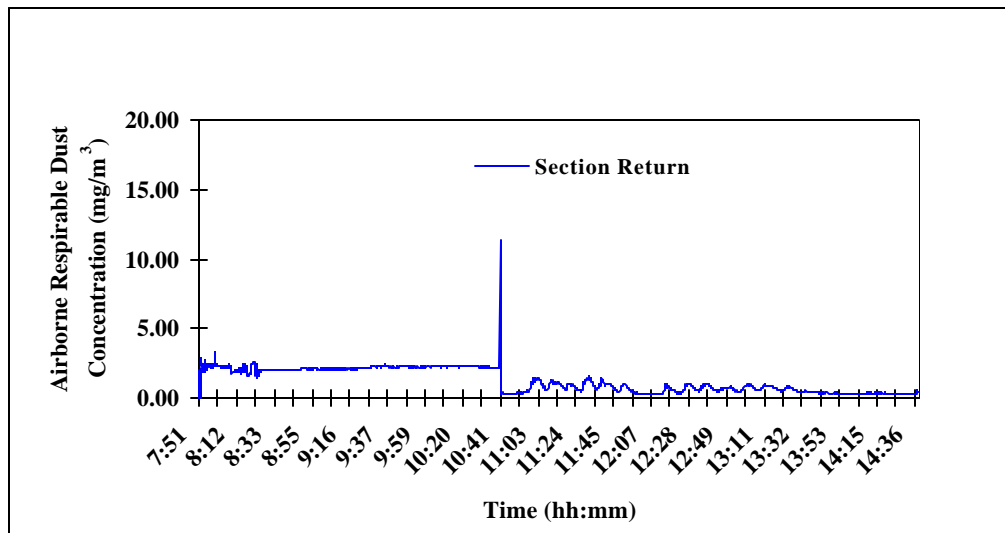
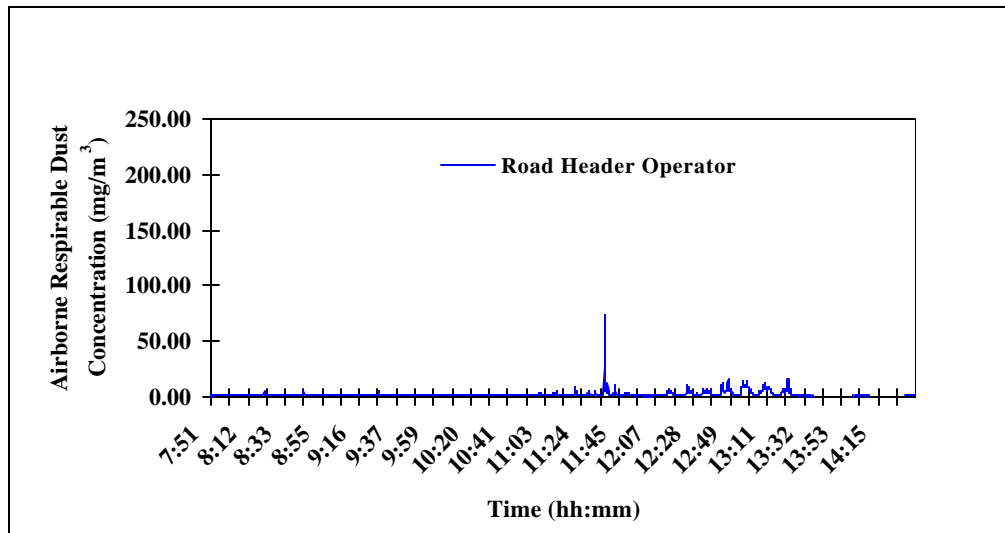

Figure A13: ARD concentration profile recorded by the real-time dust monitor (Hund Tyndallometer) at the road header operator and section return positions for Test # 13

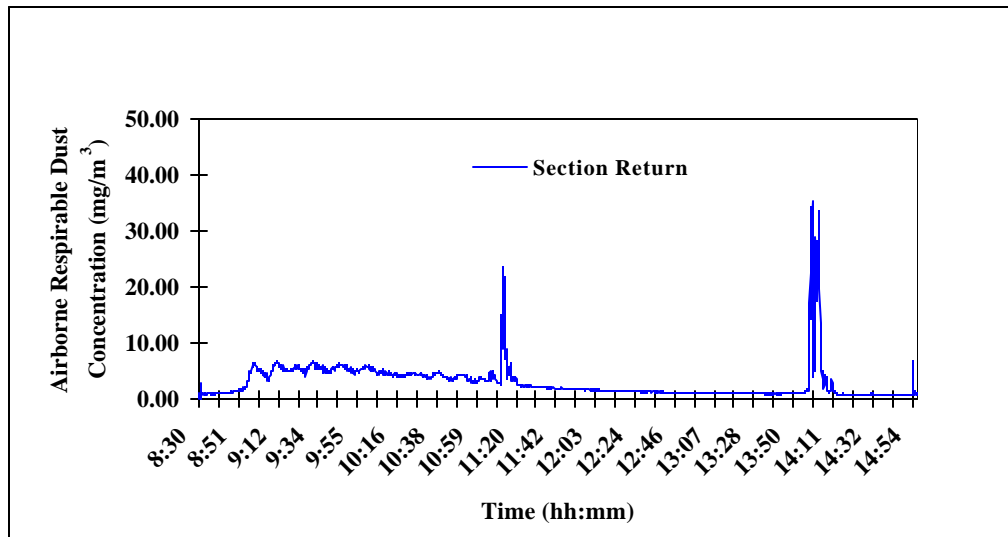
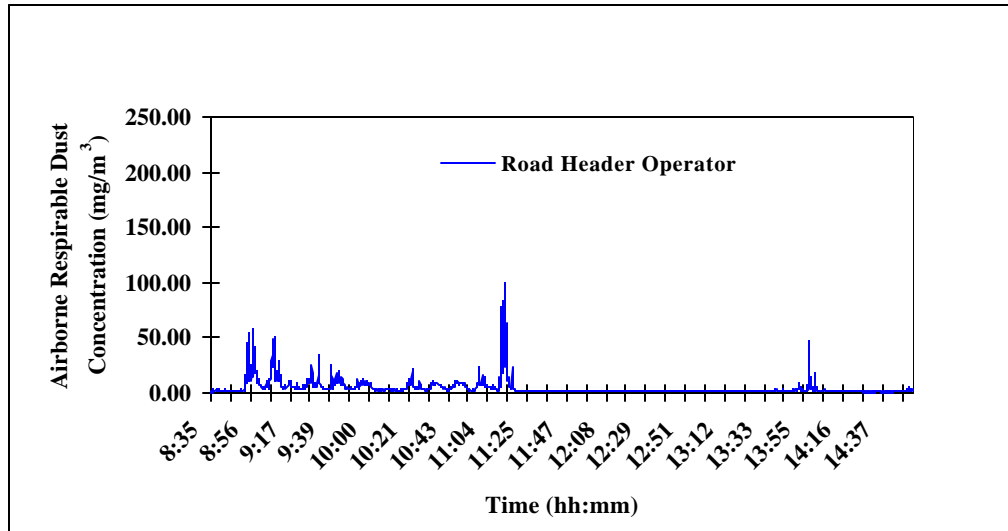

Figure A14: ARD concentration profile recorded by the real-time dust monitor (Hund Tyndallometer) at the road header operator and section return positions for Test # 14

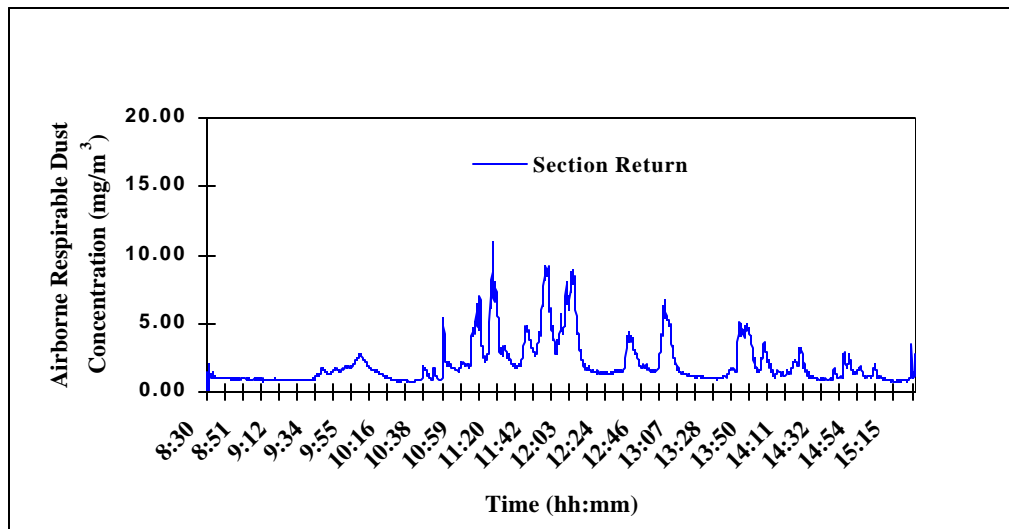
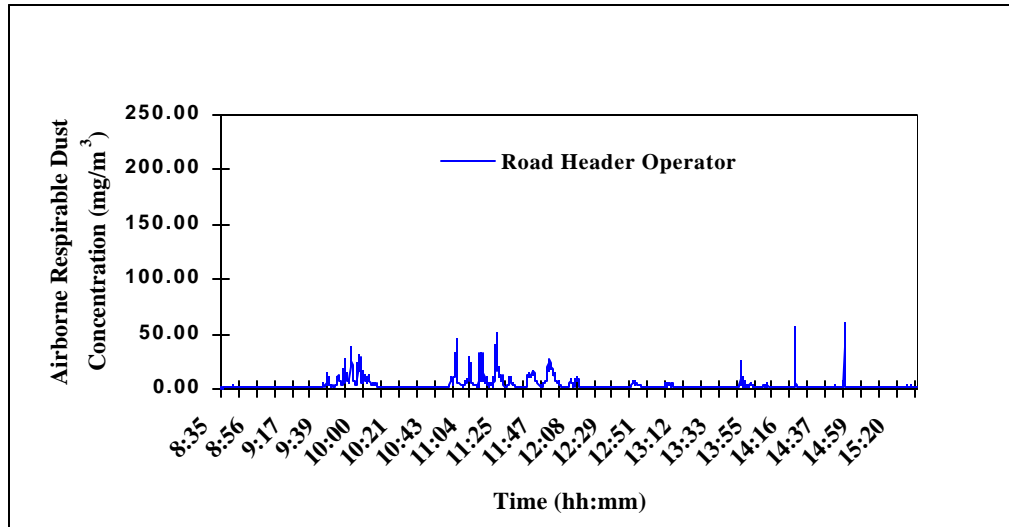

Figure A15: ARD concentration profile recorded by the real-time dust monitor (Hund Tyndallometer) at the road header operator and section return positions for Test # 15

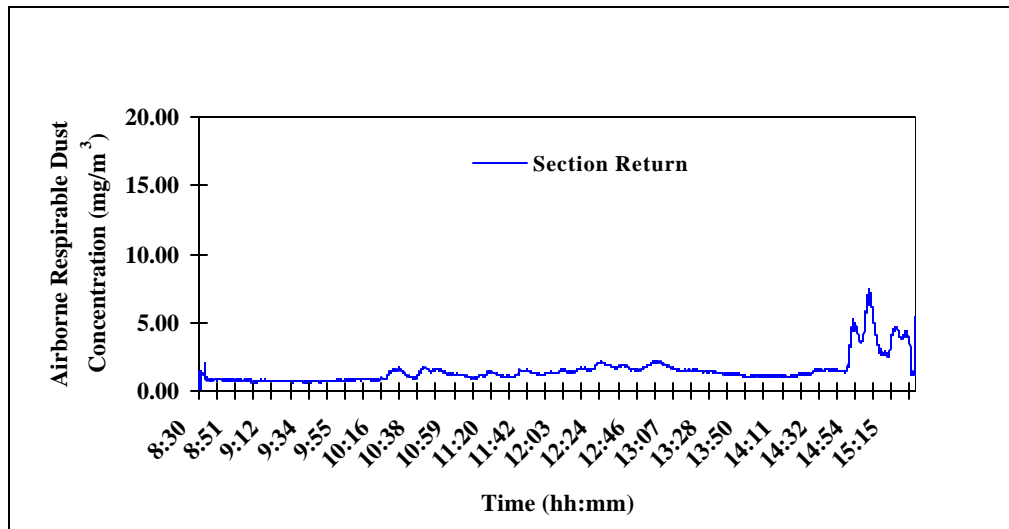
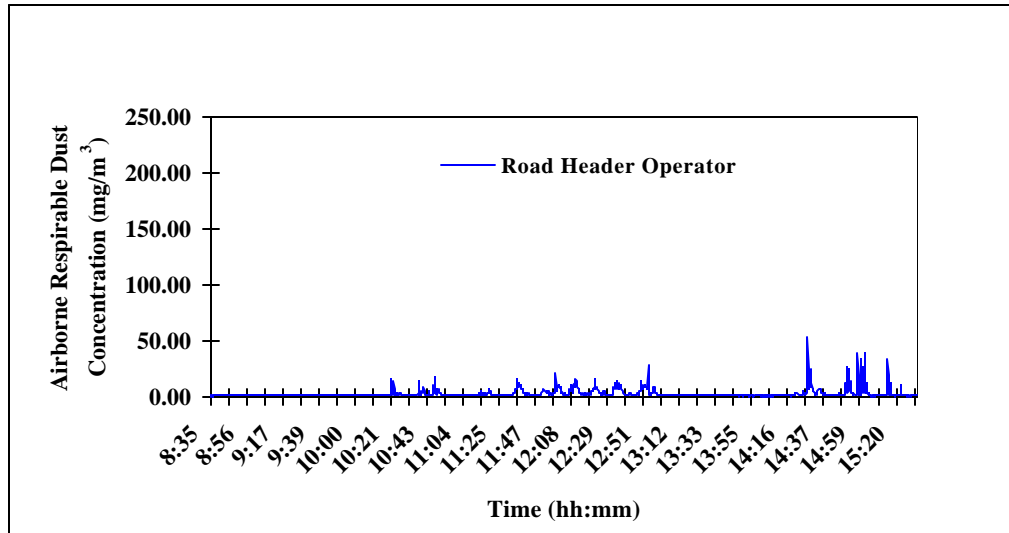

Figure A16: ARD concentration profile recorded by the real-time dust monitor (Hund Tyndallometer) at the road header operator and section return positions for Test # 16

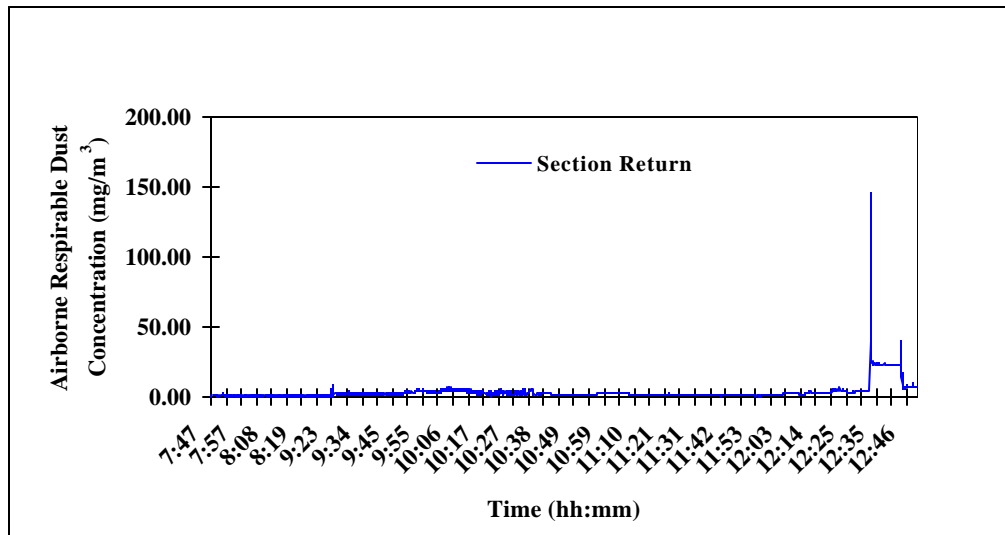
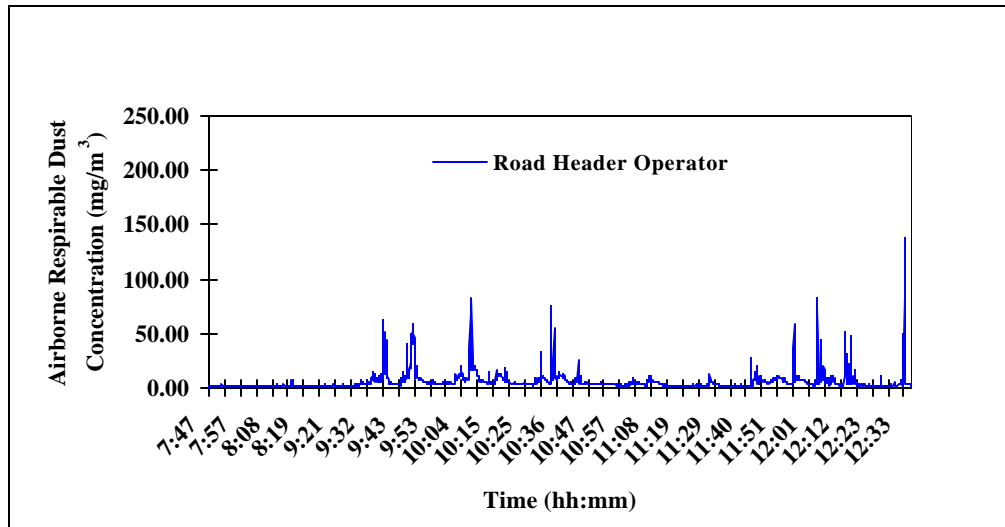

Figure A17: ARD concentration profile recorded by the real-time dust monitor (Hund Tyndallometer) at the road header operator and section return positions for Test # 17

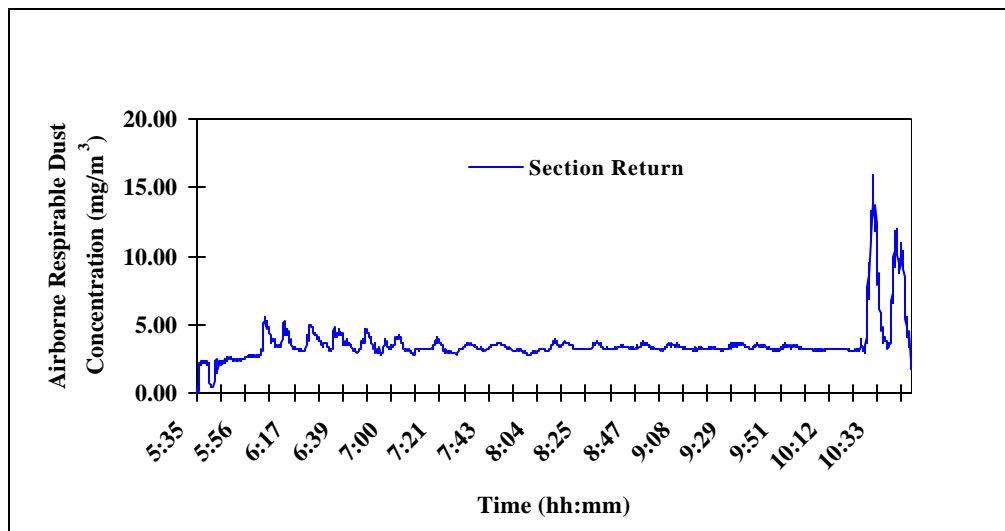
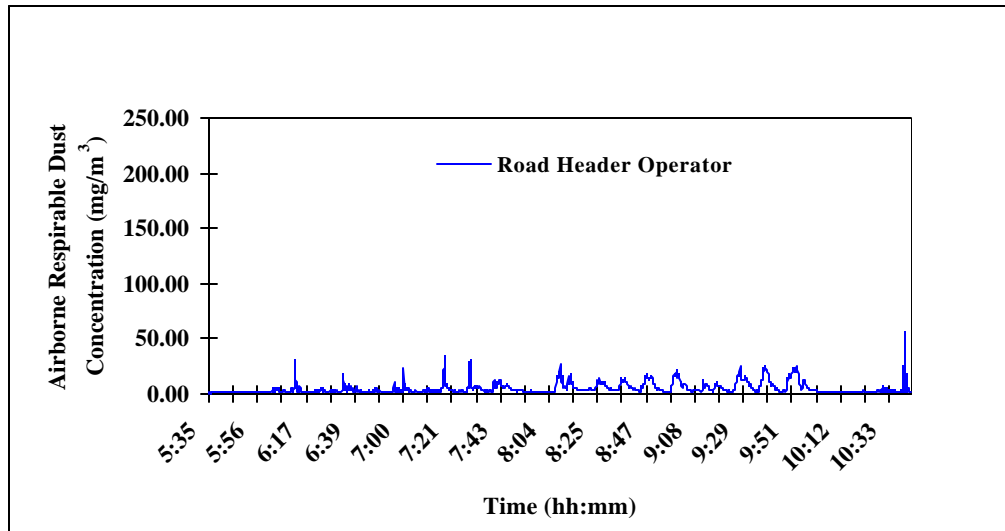

Figure A18: ARD concentration profile recorded by the real-time dust monitor (Hund Tyndallometer) at the road header operator and section return positions for Test # 18

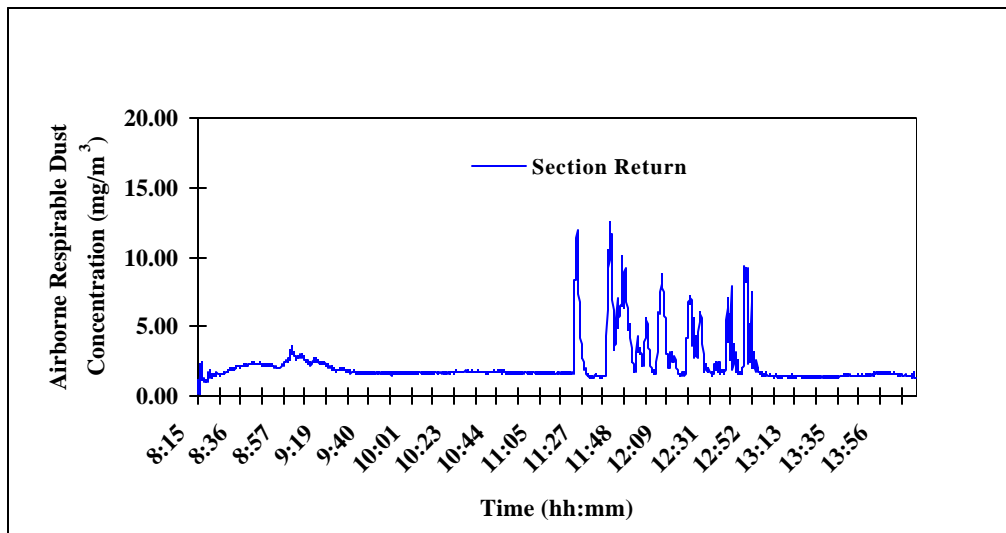
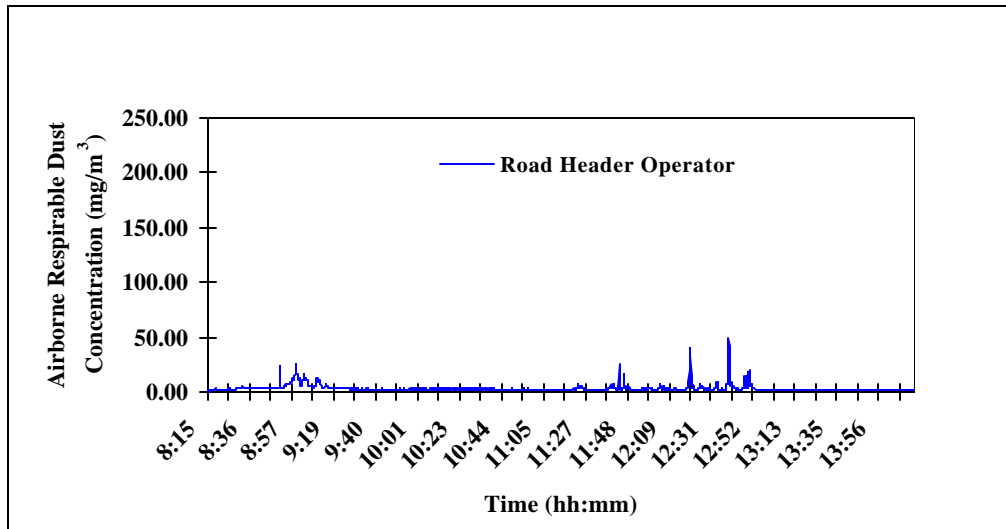

Figure A19: ARD concentration profile recorded by the real-time dust monitor (Hund Tyndallometer) at the road header operator and section return positions for Test # 19

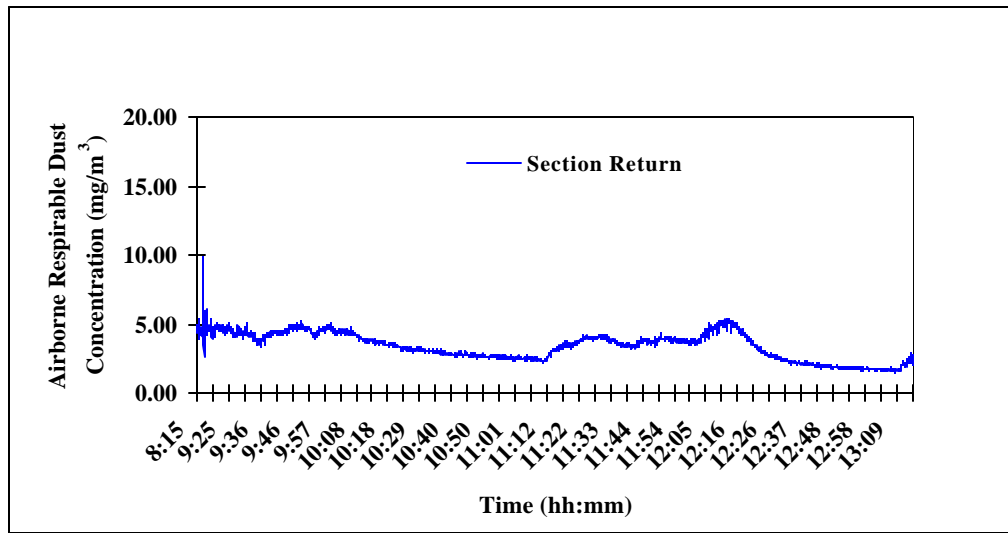
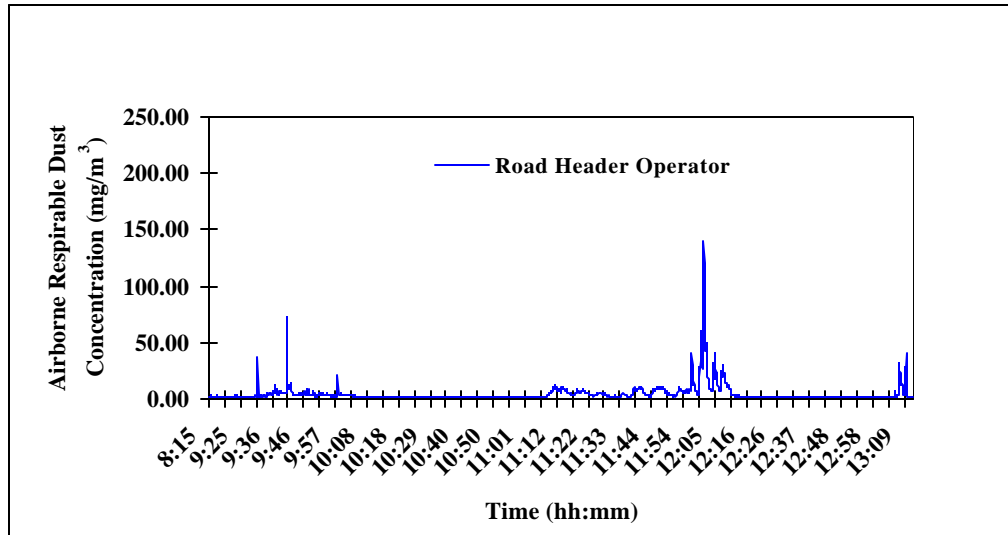

Figure A20: ARD concentration profile recorded by the real-time dust monitor (Hund Tyndallometer) at the road header operator and section return positions for Test # 20

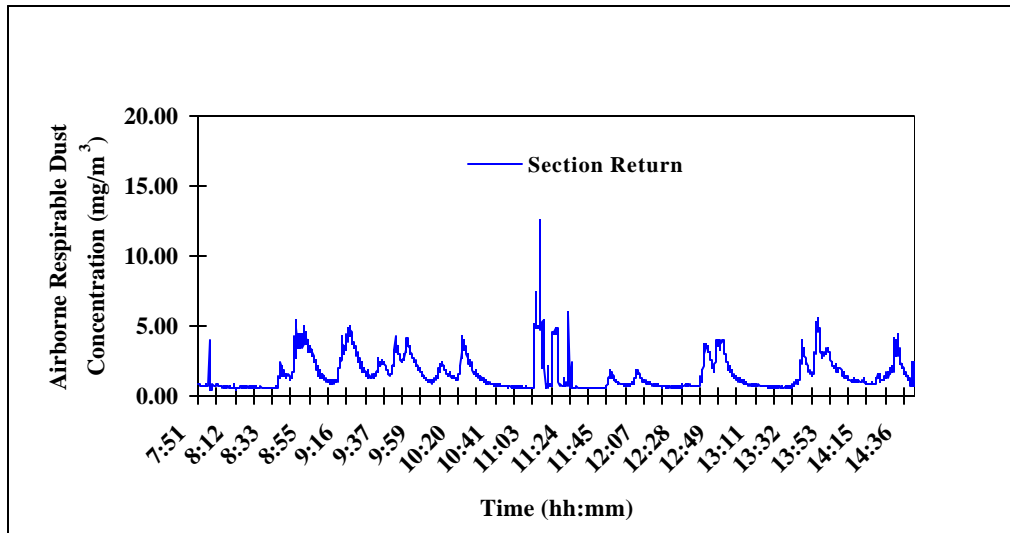
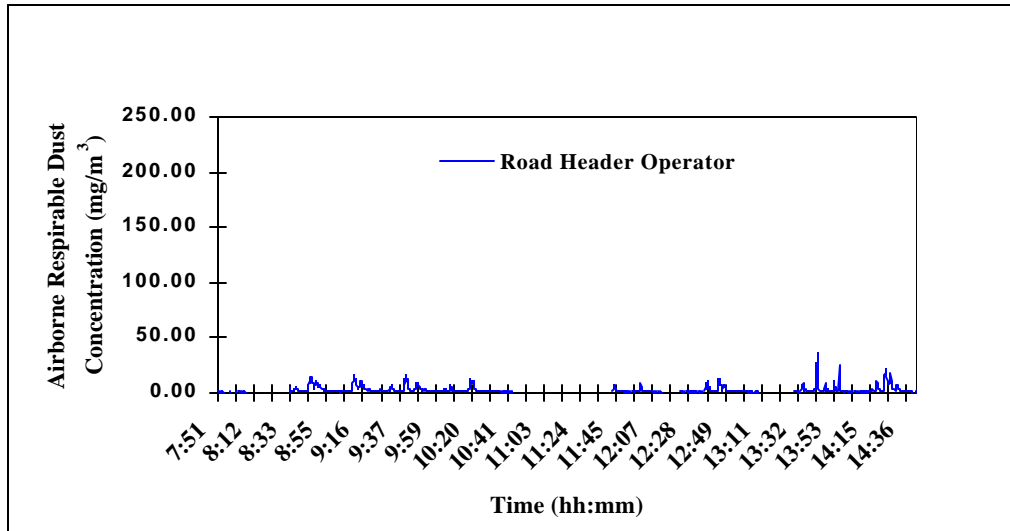

Figure A21: ARD concentration profile recorded by the real-time dust monitor (Hund Tyndallometer) at the road header operator and section return positions for Test # 21

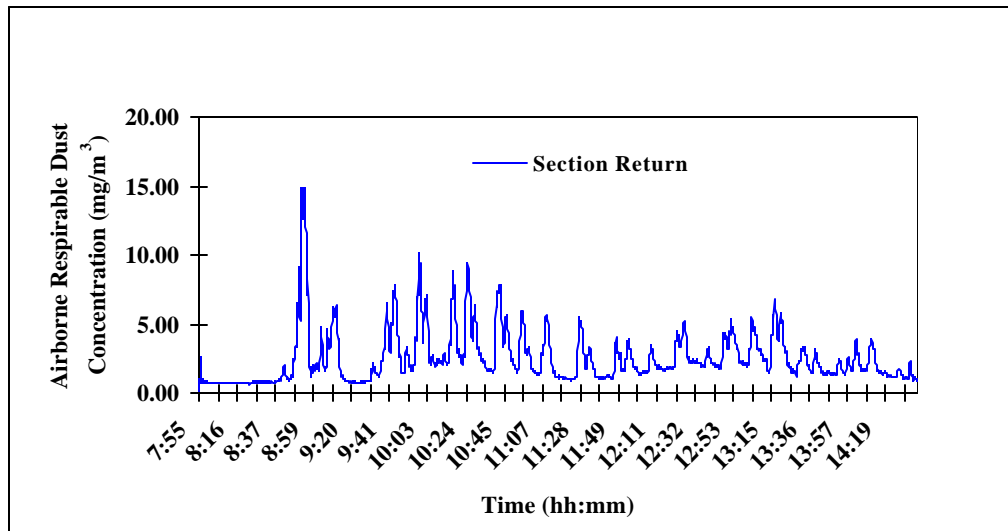
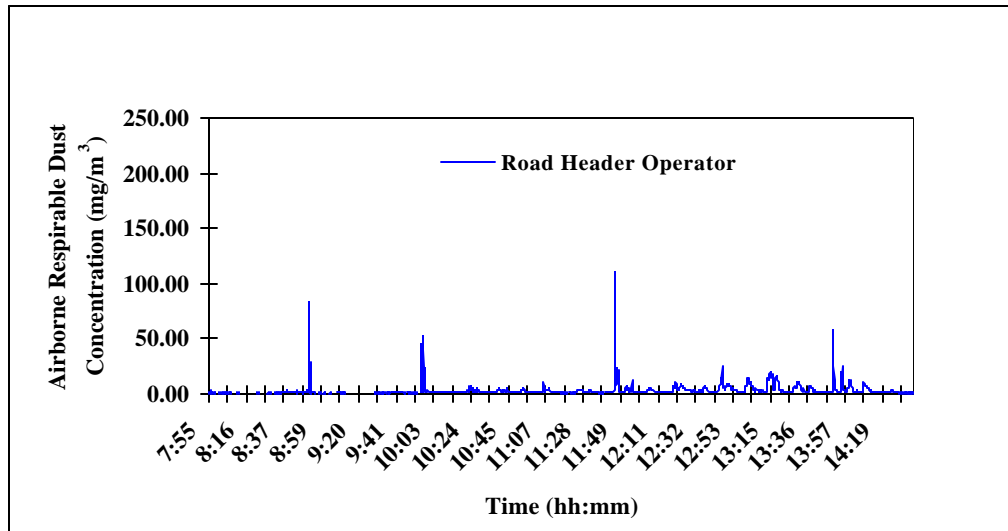

Figure A22: ARD concentration profile recorded by the real-time dust monitor (Hund Tyndallometer) at the road header operator and section return positions for Test # 22

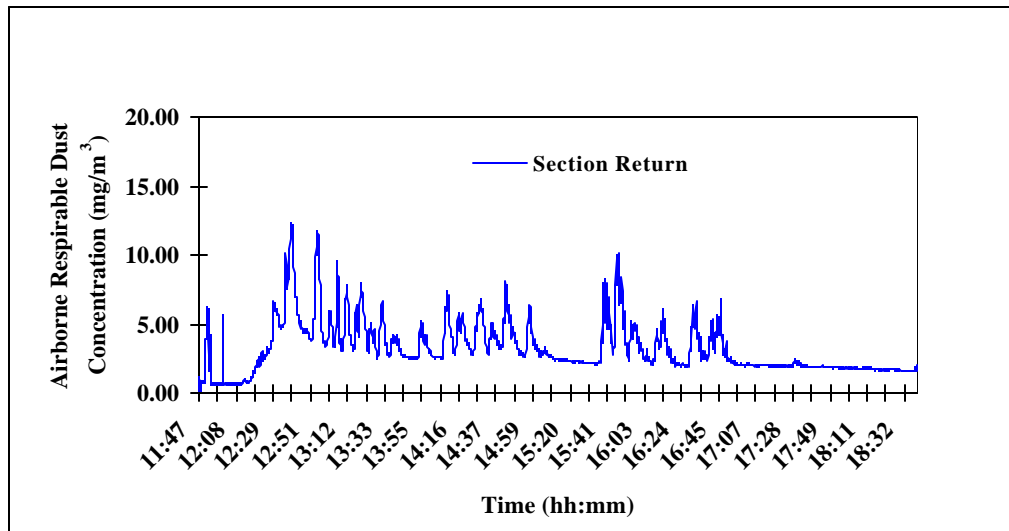
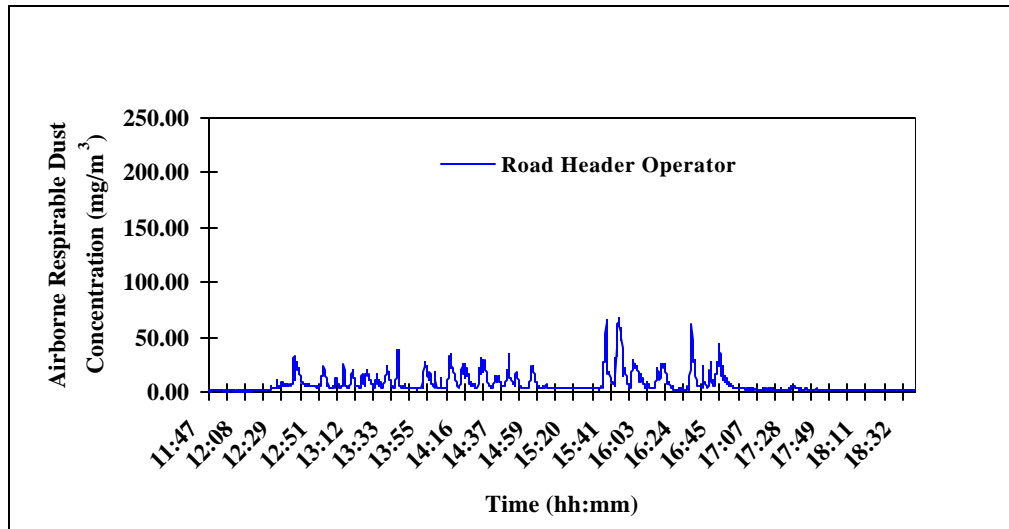

Figure A23: ARD concentration profile recorded by the real-time dust monitor (Hund Tyndallometer) at the road header operator and section return positions for Test # 23

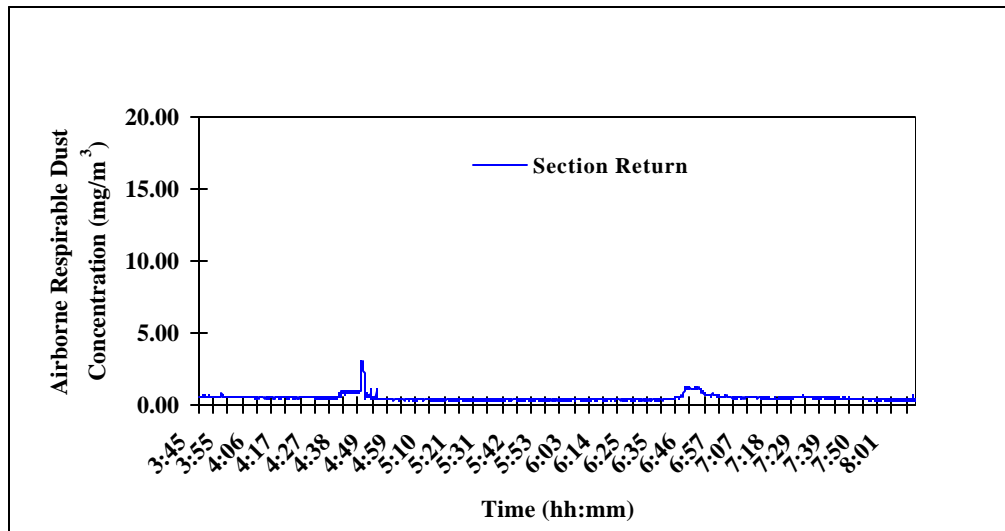
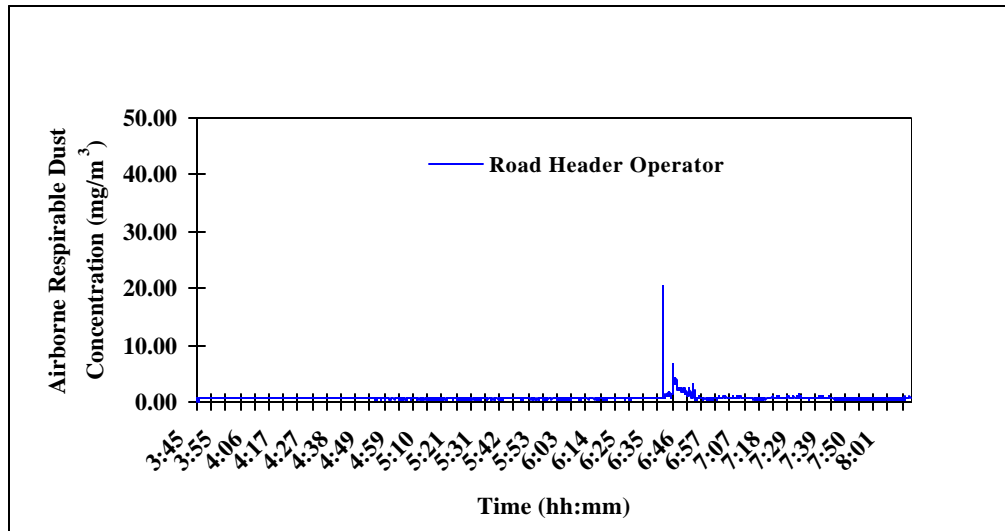

Figure A24: ARD concentration profile recorded by the real-time dust monitor (Hund Tyndallometer) at the road header operator and section return positions for Test # 24

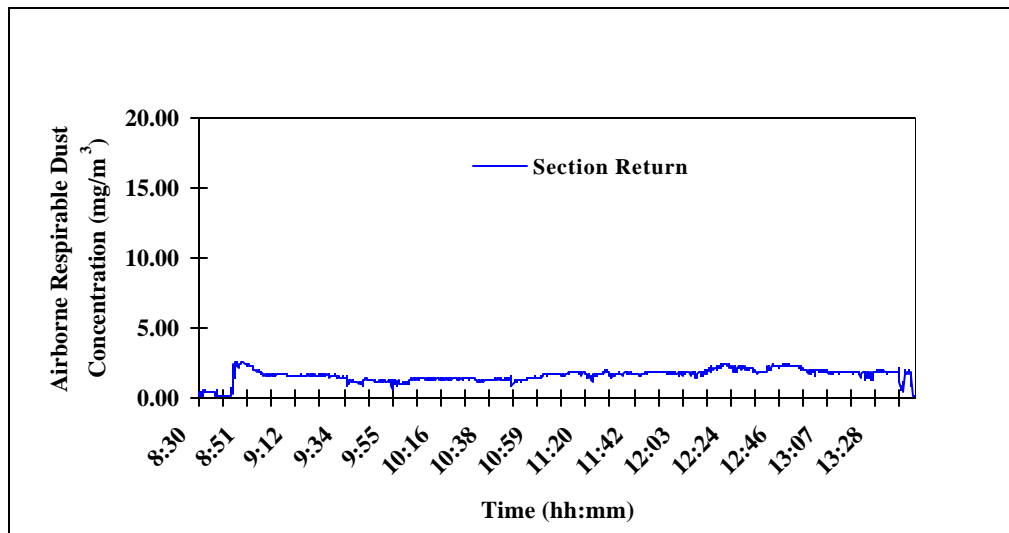
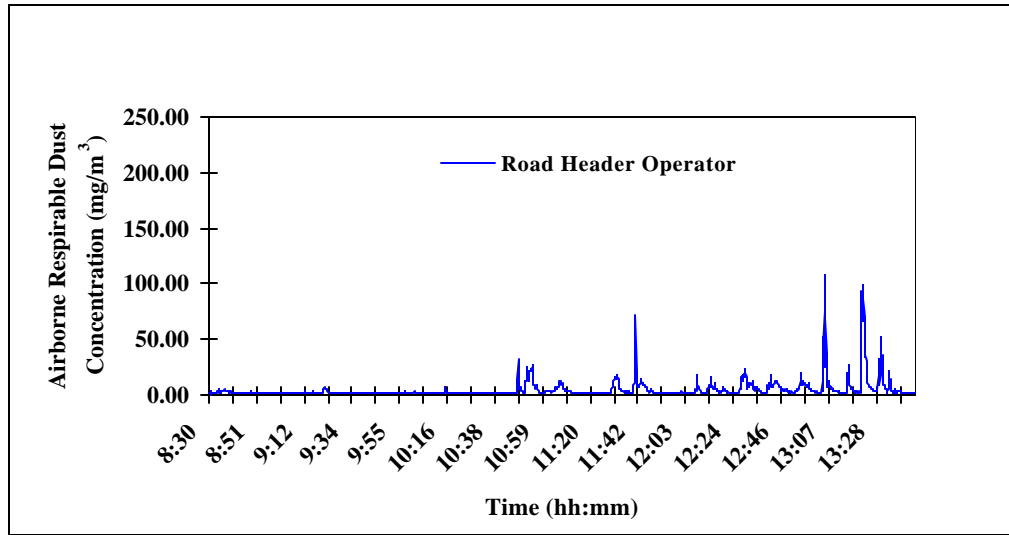

Figure A25: ARD concentration profile recorded by the real-time dust monitor (Hund Tyndallometer) at the road header operator and section return positions for Test # 25