

Biology at a single cell level



**Patience Mthunzi
National Laser Centre**

09 October 2012

***E-mail: pmthunzi@csir.co.za**

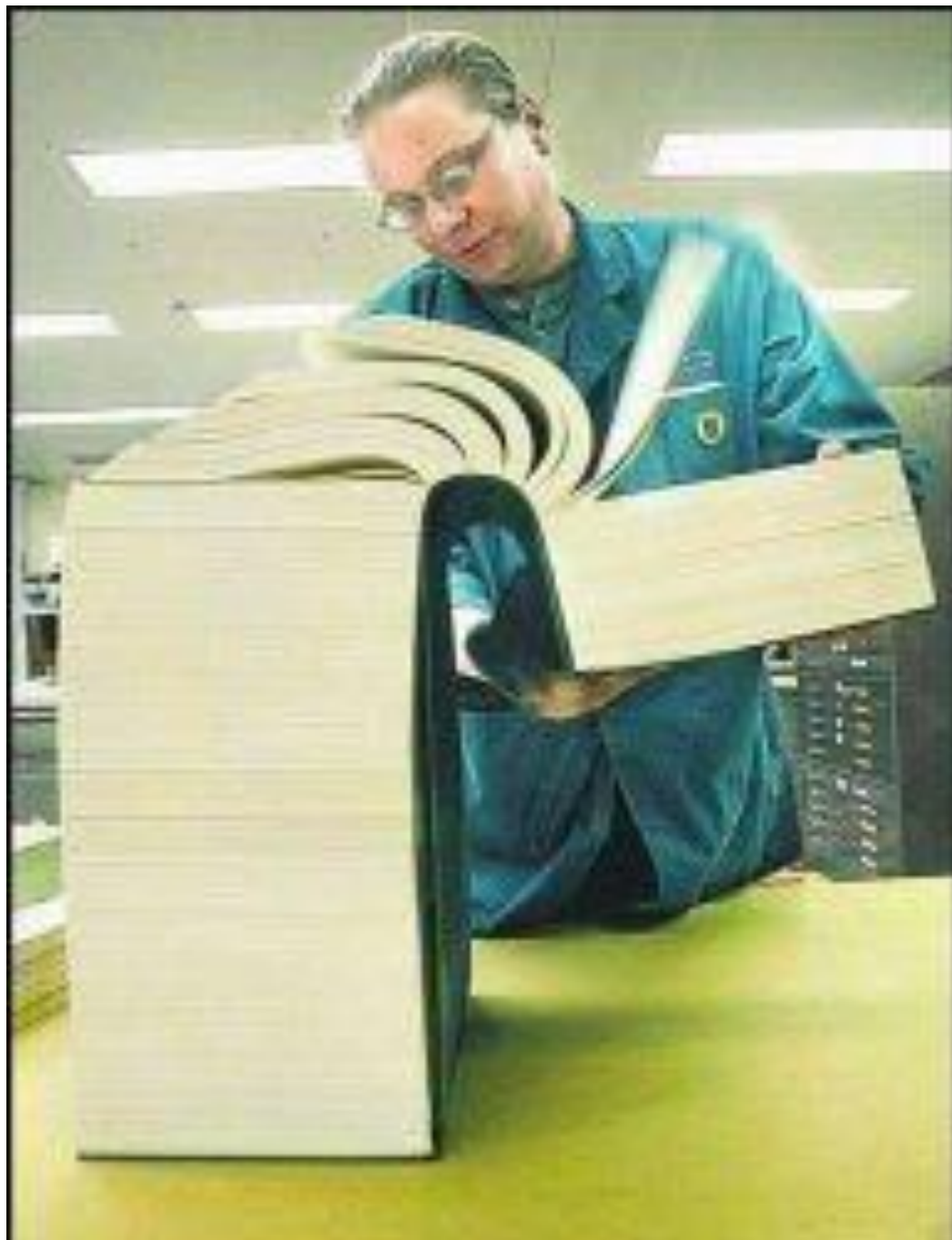

**The book
"Understanding
Women" has
finally arrived in
book stores.**

<http://www.traemcneely.com>

Living Organisms

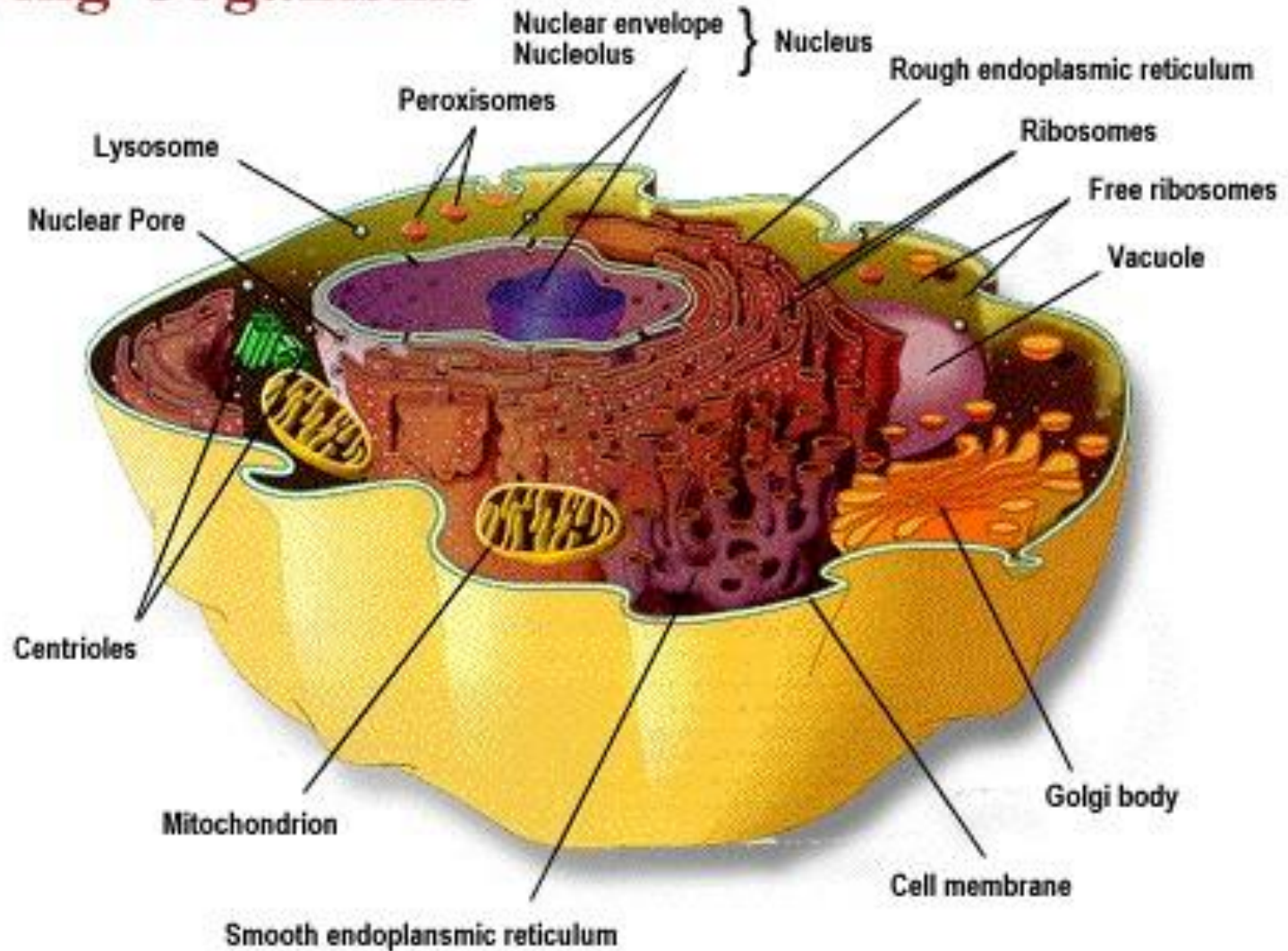

Animal Cell (eukaryote)

Lasers allow single cell micro-manipulation

- Optical cell transfection and differentiation in pluripotent stem cells
- Neuroblastoma cells are optical transfection
- Healthy cell optical tweezing
- Optically sorting cancer cells from mixed population



Stem cell research

Embryonic stem cells

Pluripotent Stem Cells

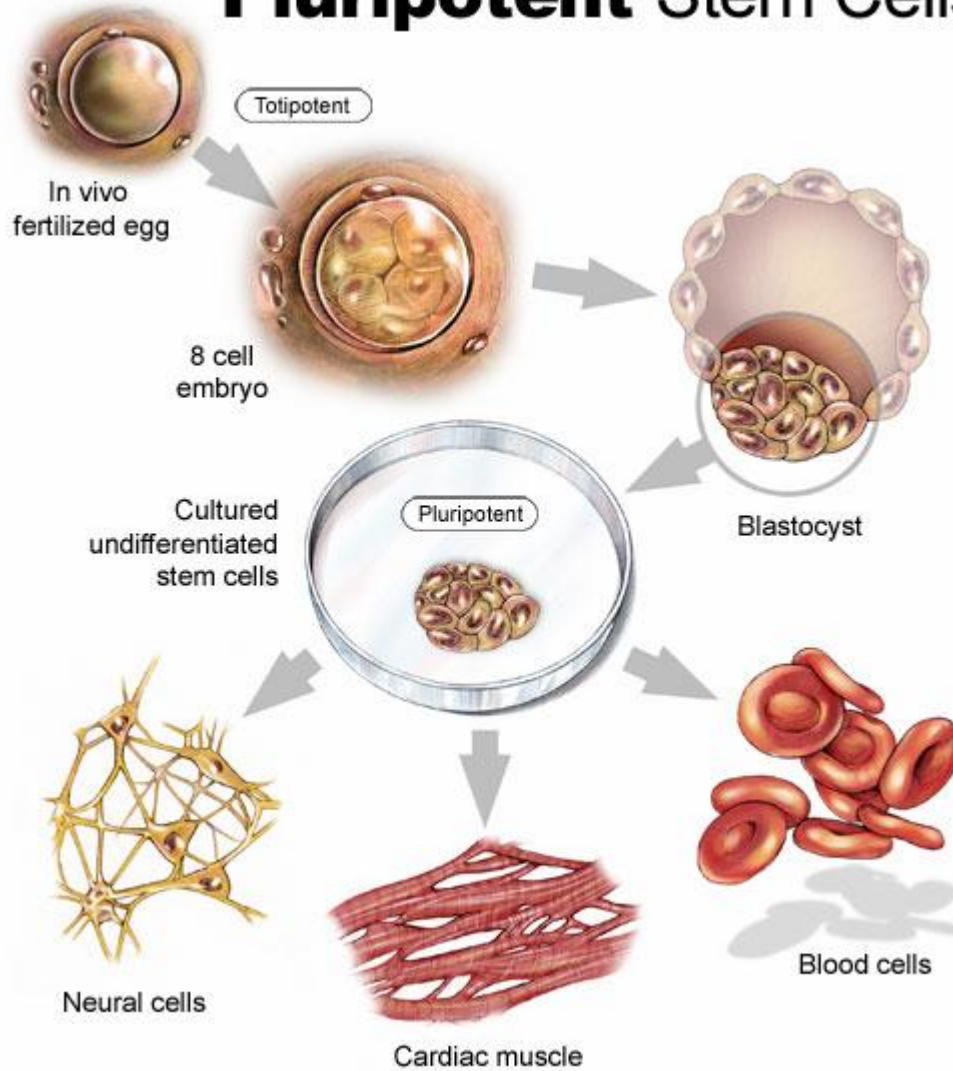

Stem cell research at NLC

Anatomy of the Knee

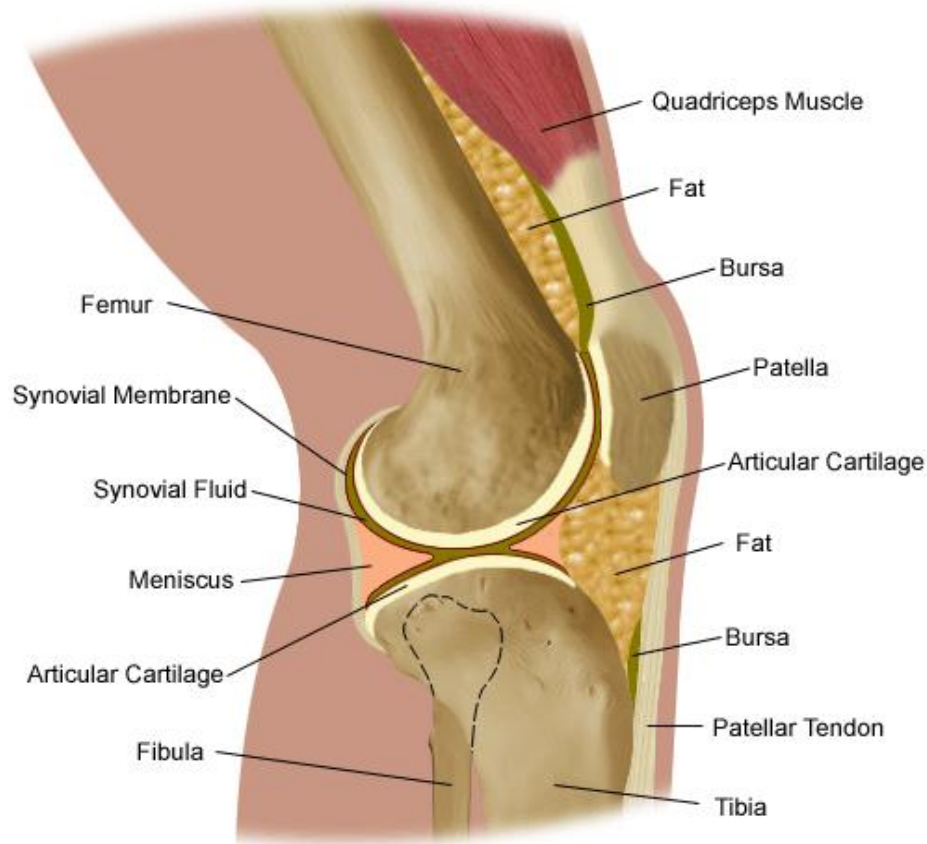

Knee Osteoarthritis



<http://www.eorthopod.com/content/osteoarthritis-knee>

<http://www.lpch.org/DiseaseHealthInfo/HealthLibrary/arthritis>

ES-E14TG2a mouse embryonic stem cells

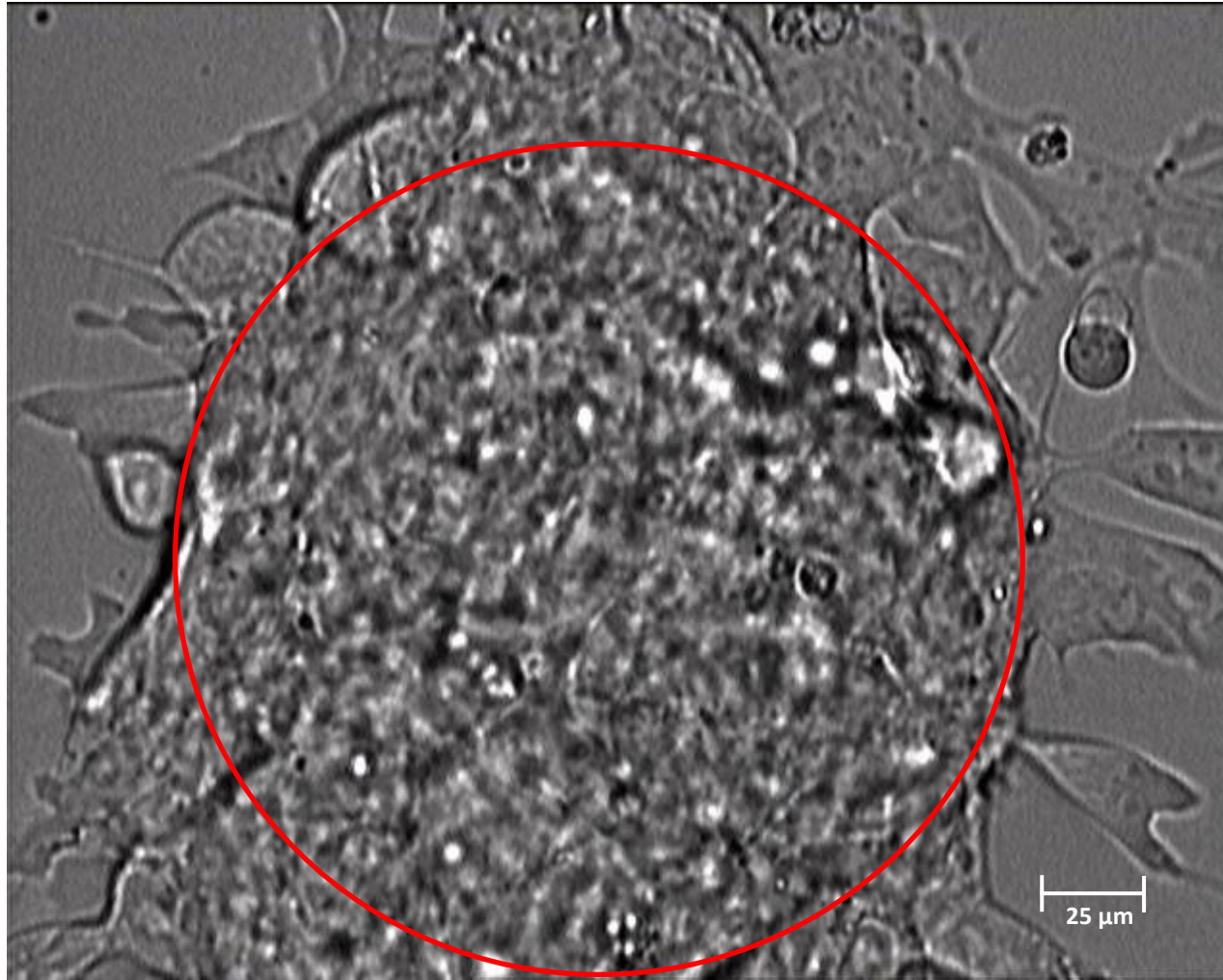

Optical Setup

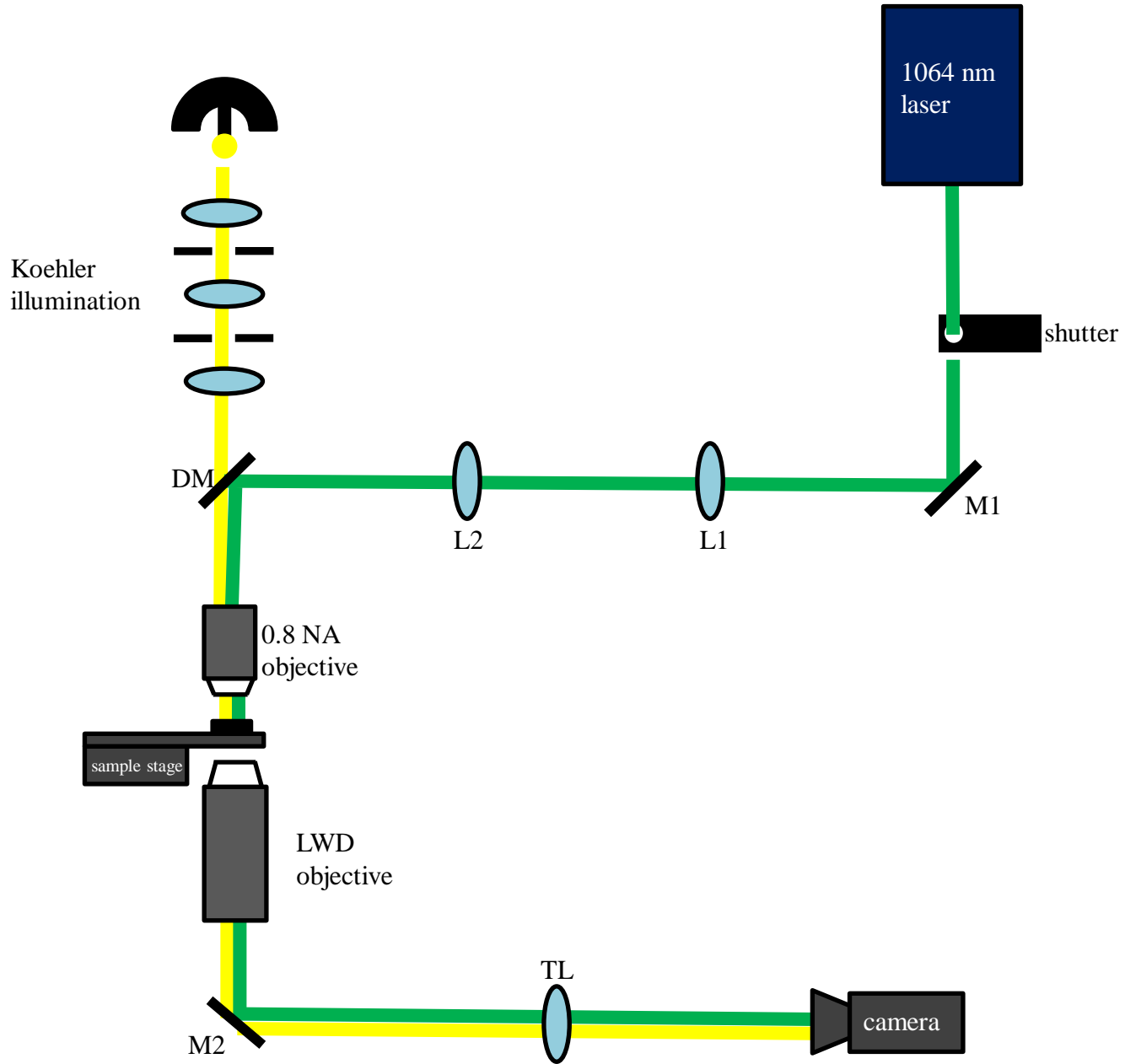

The Optical transfection experiment

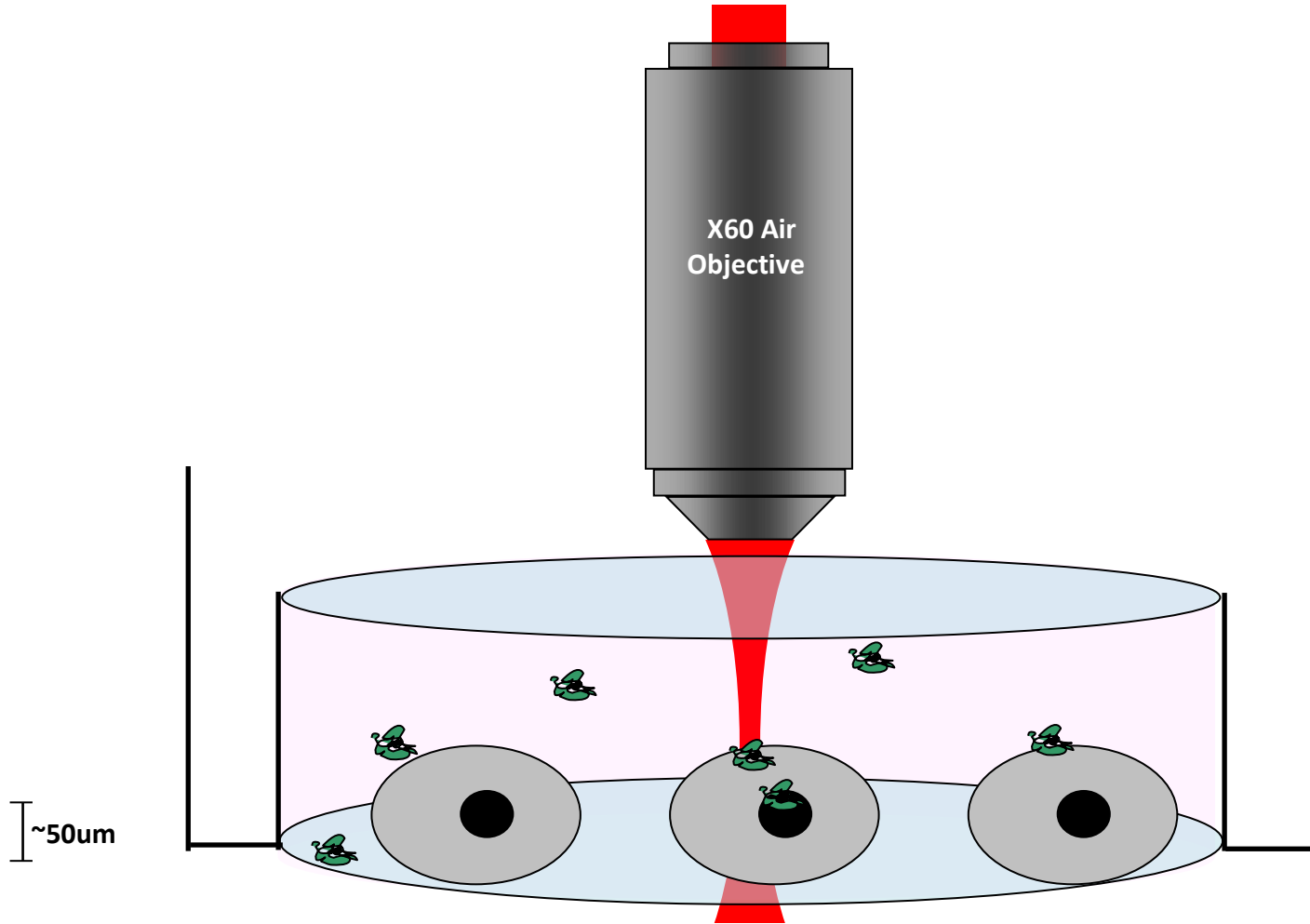

E14Tg2a transfection and differentiation

Optical Parameters: 1064 nm, 80 MHz, 300 fs, 60 mW, 40 ms



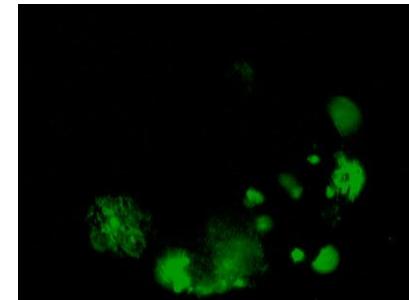
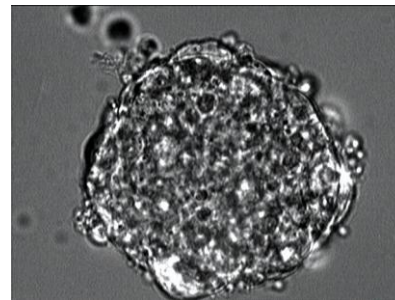

P. Mthunzi et. al, SPIE Proc., 8097, 809723-1 – 10, 2011

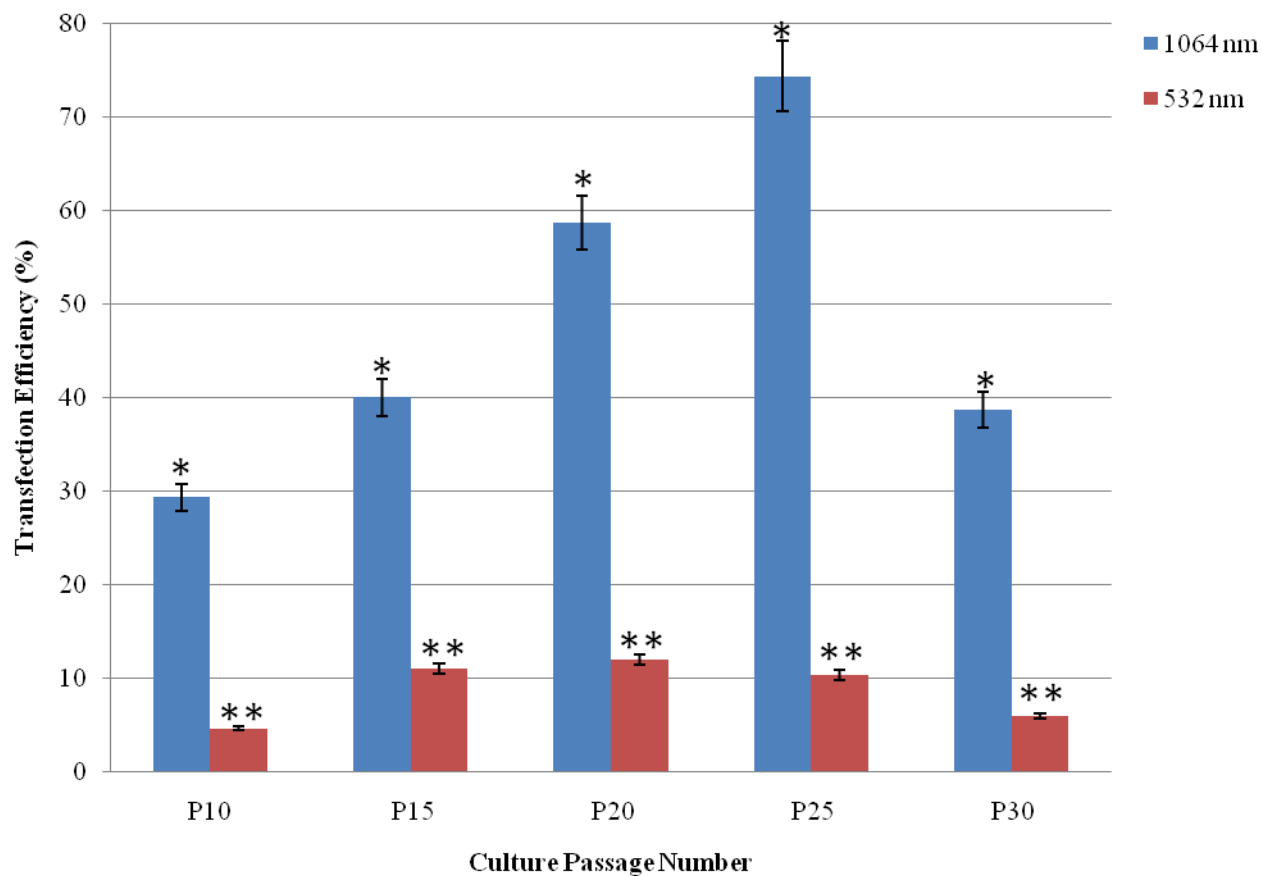

P. Mthunzi, SPIE Proc., 8458, 845822-1 – 6, 2012

Cells expressing the Gata-6 gene resistant to hygromycin

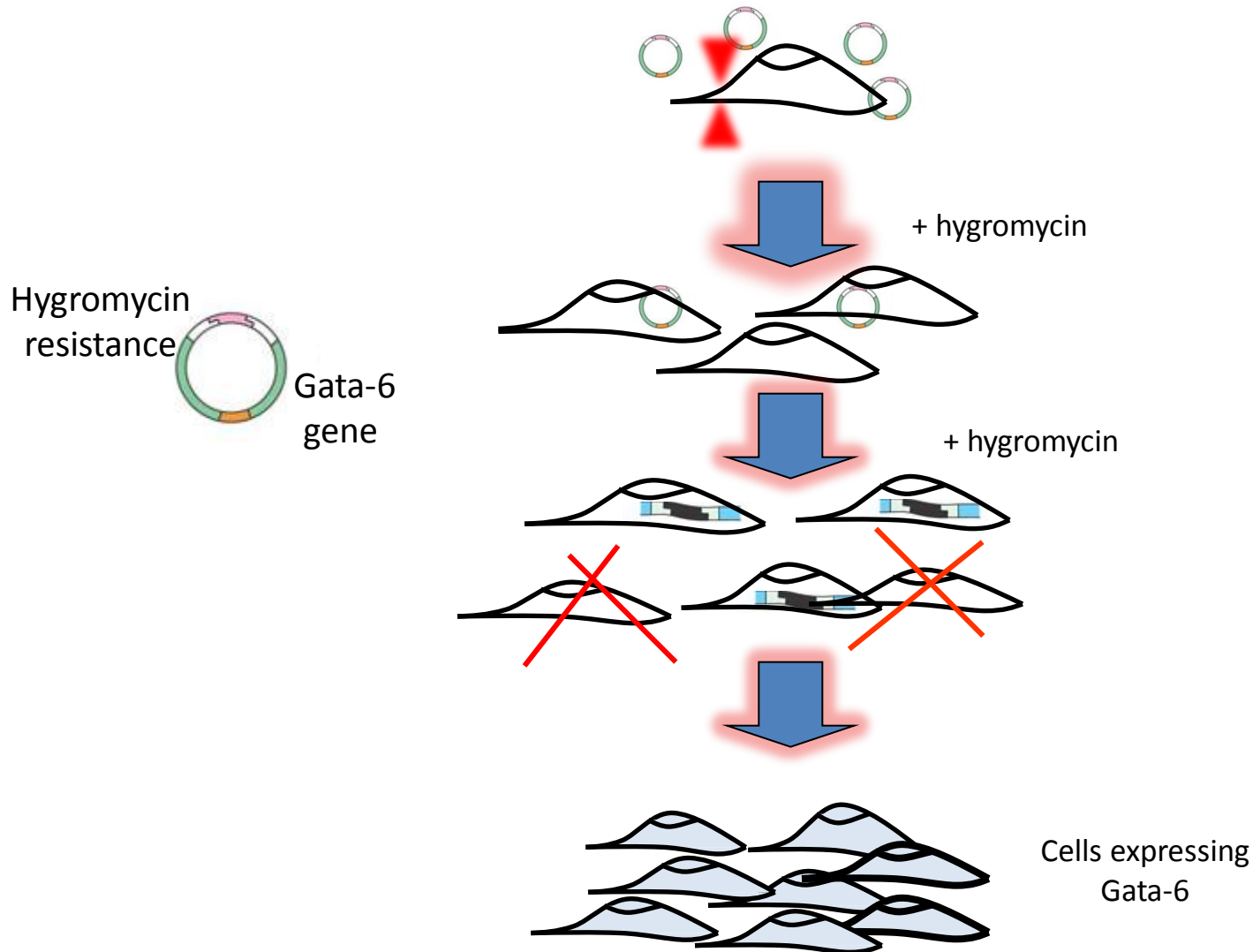

Embryonic stem cells expressing the Gata-6 gene

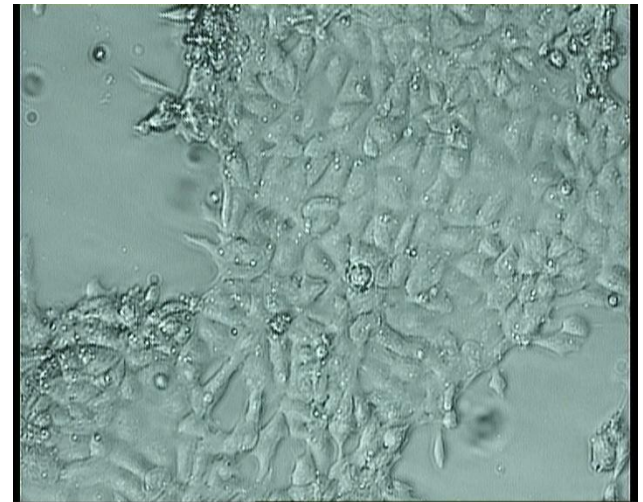
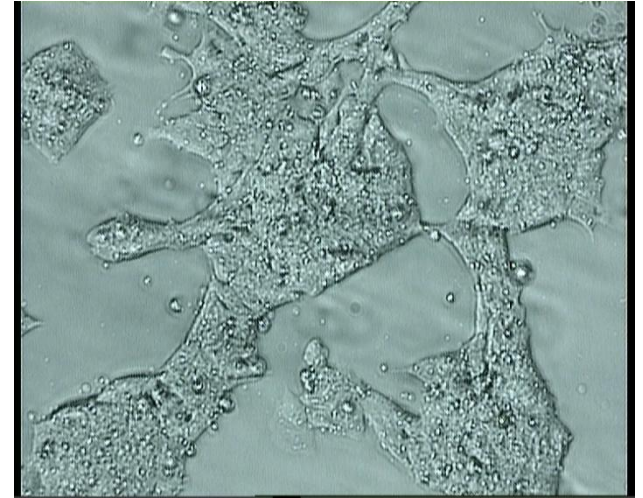
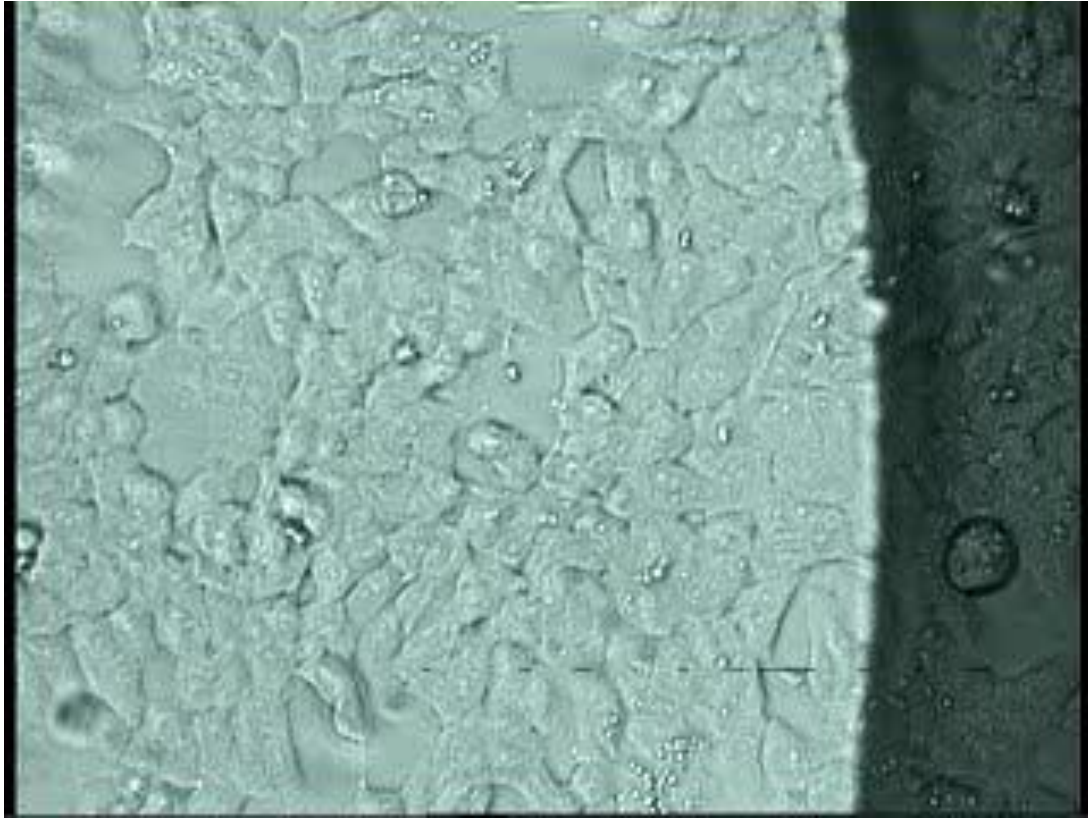

Induced pluripotent stem cells

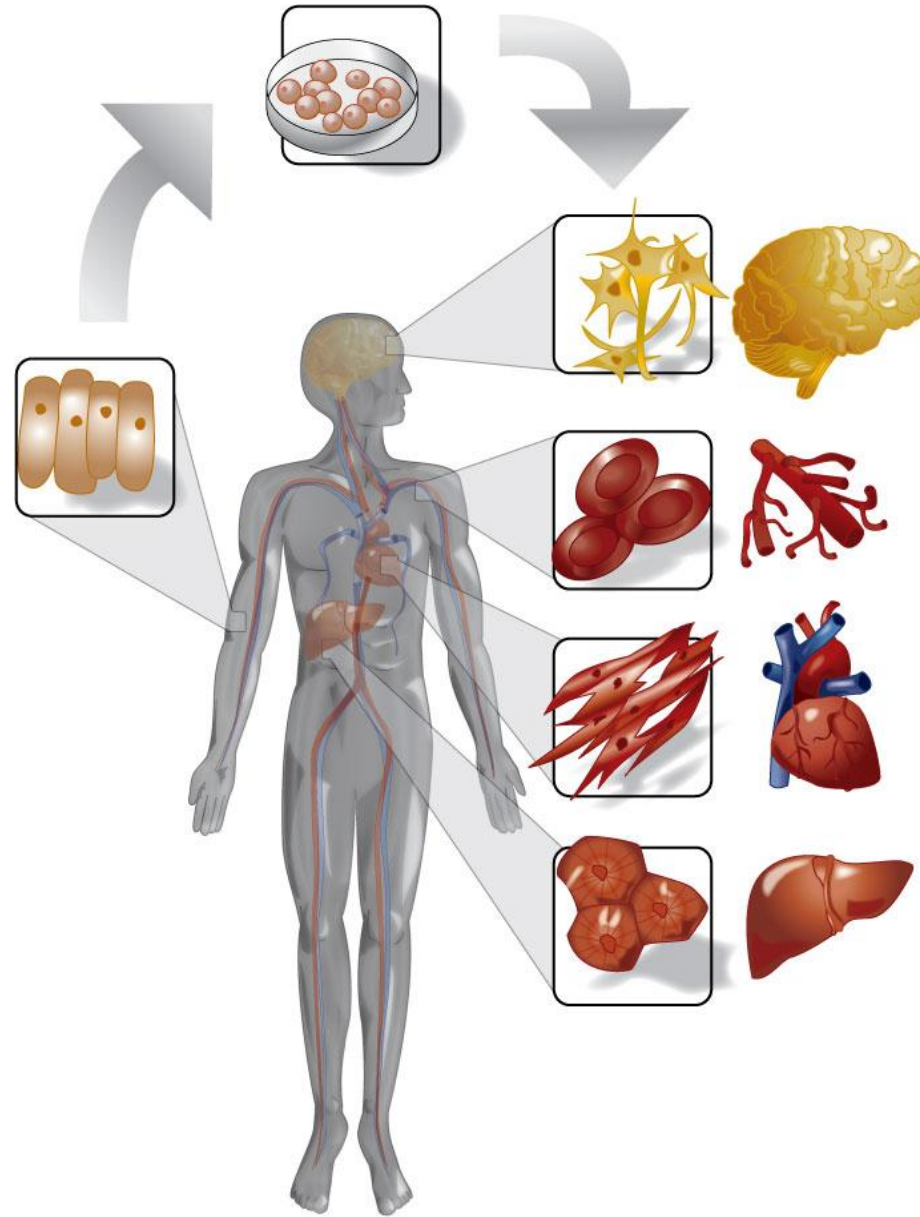

Induced pluripotent stem cells differentiated in culture



<http://www.youtube.com/watch?v=ECllrIzTKbA&feature=related>



Transfecting neuroblastomas

Neuroblastoma

- **Brain cells**
- **80 – 120 billion neurons in human brain**
- **Non- renewing cell type**
- **Neurons difficult to transfect with established protocols**
- **Susceptible to degenerative disorders:**
 - **Parkinson's disease**
 - **Multiple sclerosis**
 - **Alzheimer's disease**

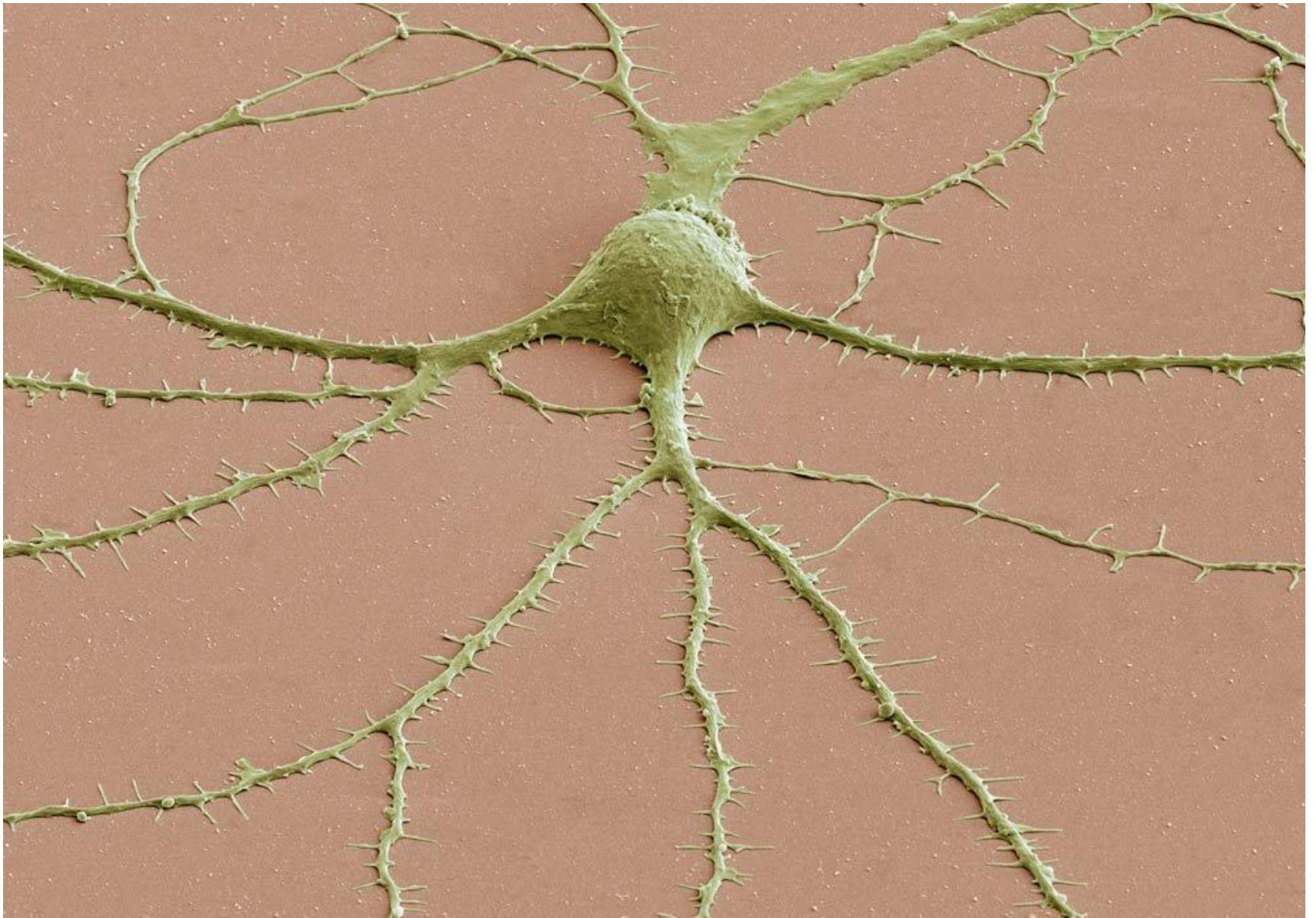

MIT neurite outgrowth video



http://www.youtube.com/watch?v=n_9YTeEHp1E&feature=related

NG108-15 optical transfection

Optical Parameters: 1064 nm, 80 MHz, 200 fs, 60 mW, 40 ms





Optical tweezing & sorting

Optical tweezers setup

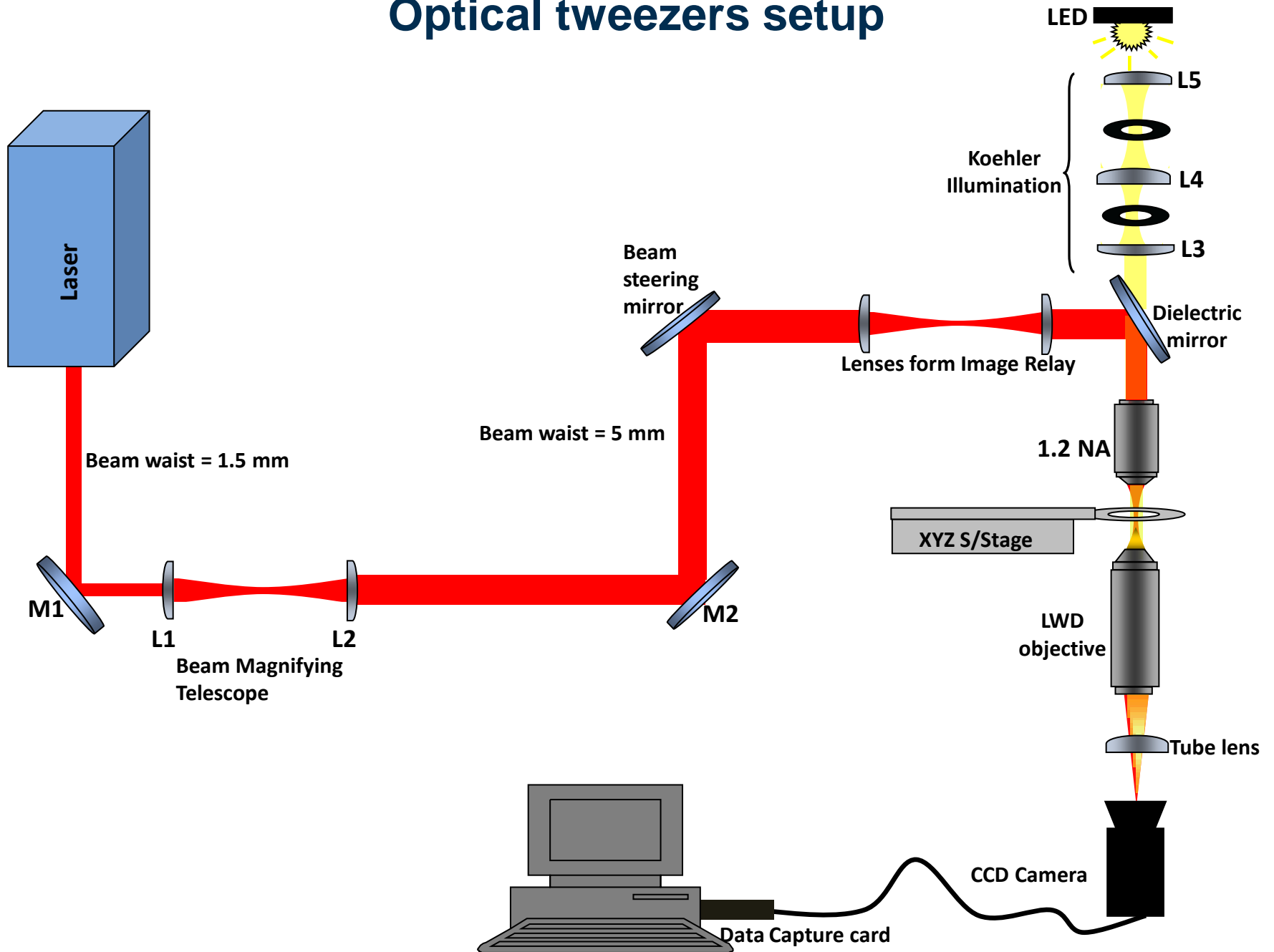

3D vs. 2D Trap

- High N.A. objective lens is required to produce strong axial gradients necessary for stable 3D trapping

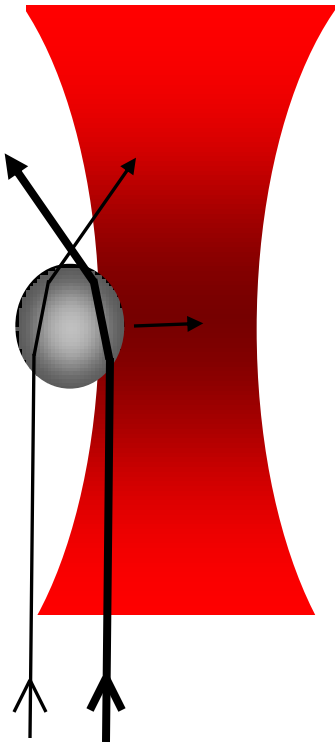

- Low N.A. objective lens create a diverging Gaussian beam

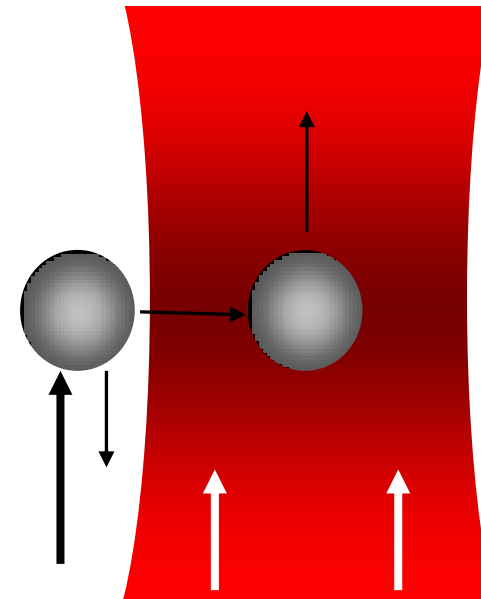

Optical cell sorting

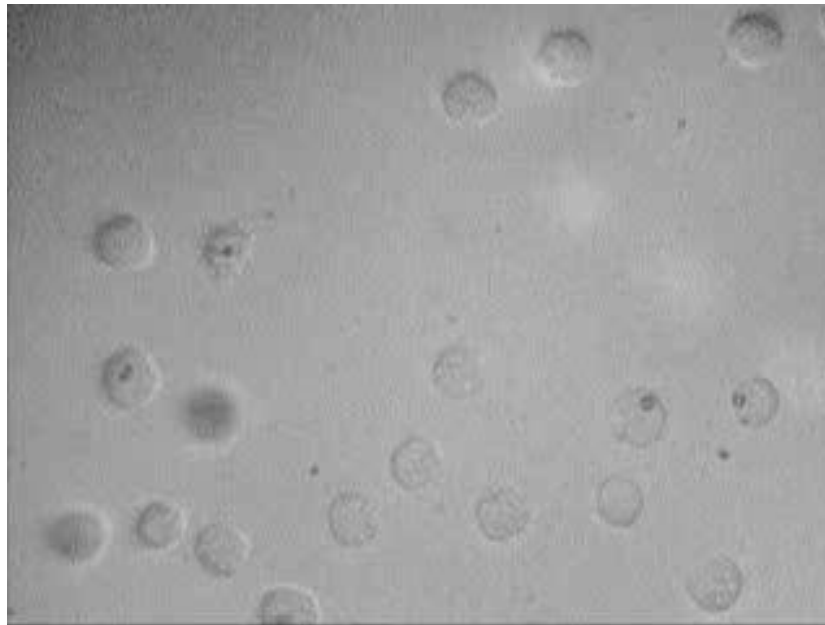
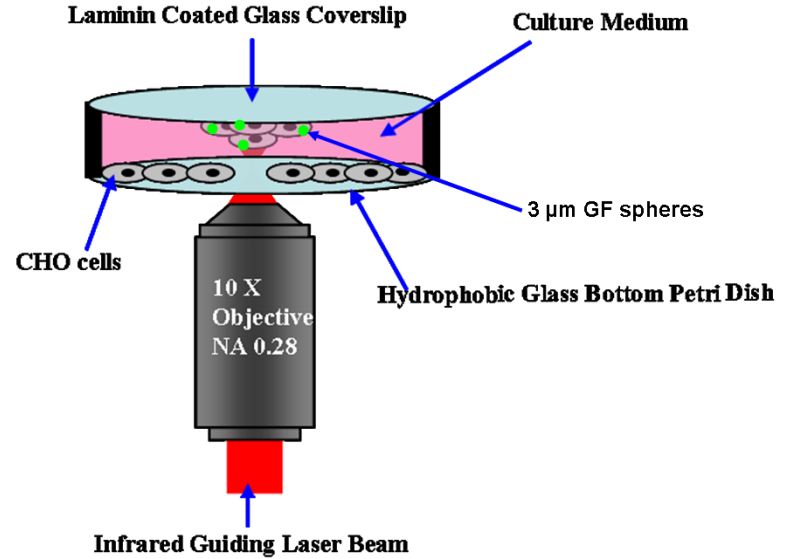
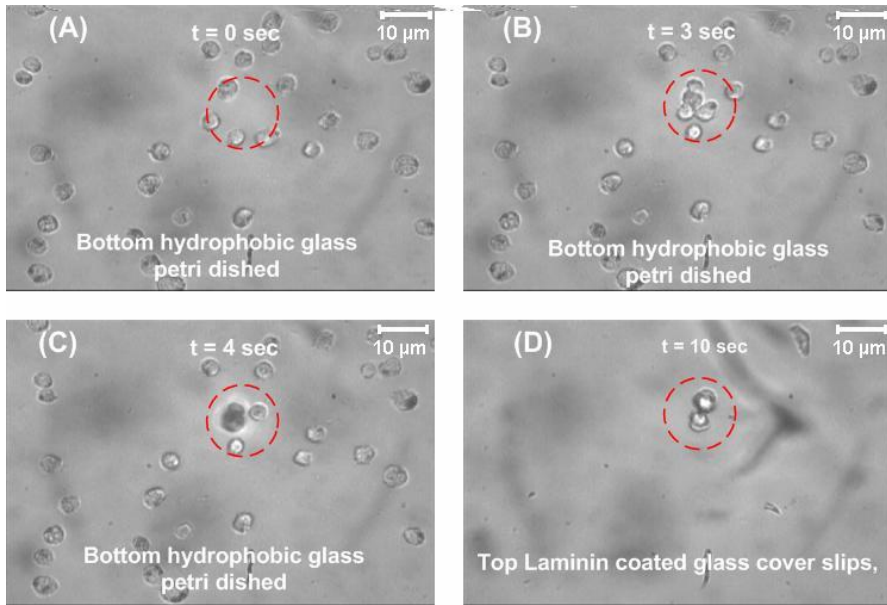

Conclusion



- Non-invasive optical stem cell transfection and differentiation
- 1064 nm femtosecond laser pulses used for the first time to efficiently transfect neuroblastoma cells
- Diseased cells can be optically sorted from healthy ones in a mixed population
- Optical techniques have potential for novel applications

Ngiyabonga!

