

# **SAFETY IN MINES RESEARCH ADVISORY COMMITTEE**

## **FINAL REPORT**

### **An evaluation of international and local magnetic rope testing instrument defect detection capabilities and resolution, particularly in respect of low rotation, multi-layer rope constructions**

**Martin Dohm**

**Research Agency:  
Project Number:  
Date:**

**AATS a Division of Anglo American Corporation of SA  
GAP 503 and GAP 535  
May 1999**

# Table of contents

	<b>Page</b>	
<b>1</b>	<b>Introduction and background</b>	<b>7</b>
1.1	Problem statement	10
1.1.1	Rope condition assessment in terms of broken wires	10
1.1.2	Rope condition assessment in terms of corrosion	10
1.2	Objectives of this study	10
1.2.1	Main objective	10
1.2.2	Other objectives	11
1.2.2.1	Awareness of instrument limits	11
1.2.2.2	Revision of the SABS: 0293 Code of Practice	11
1.2.2.3	Feedback to rope instrument manufacturers	11
1.2.2.4	Contribute to the knowledge pool for rope condition assessment	11
1.3	Research methodology	11
1.3.1	Broken wire detection (GAP 503)	11
1.3.2	Remaining strength estimated of a corroded rope (GAP 535)	12
1.4	Deployment of the study	12
1.5	Scope of the study	12
<b>2</b>	<b>Literature search</b>	<b>12</b>
2.1	Background	12
2.2	Literature search results	13
2.3	Conclusion drawn from the literature survey	16
<b>3</b>	<b>Research methodology</b>	<b>17</b>
3.1	Choice of methodology	17
3.2	Choice of NDE experts	18
3.3	Choice of testing laboratory	19
3.4	Choice of rope samples	19
3.4.1	Corroded rope sample	19
3.4.2	Broken wire rope sample	19
3.5	Test procedures	20
3.5.1	Corroded rope sample	20
3.5.1.1	Test 1	20
3.5.1.2	Test 2	20
3.5.2	Broken wire rope sample	21
3.5.2.1	Test 1	21
3.5.2.2	Test 2	21
3.5.2.3	Test 3	22
3.6	Actual physical condition of the ropes	23
3.6.1	Destructive test of corroded rope sample	23
3.6.2	Destraining and destructive testing of broken wire sample	23

3.7	Analysis	23
3.8	GAP 503 and 535 contractual obligation	23
3.8.1	Contractual requirements – GAP 503	24
3.8.2	Contractual requirements – GAP 535	24
<b>4</b>	<b>Results</b>	<b>25</b>
4.1	Corroded rope sample	25
4.1.1	Comments by the rope inspection experts on their results	26
4.1.1.1	Noranda	26
4.1.1.2	Lloyds Beal	28
4.1.1.3	DMT	28
4.1.1.4	NDT Technologies	28
4.1.1.5	University of Stuttgart	31
4.1.1.6	AATS	31
4.1.1.7	Meraster	32
4.1.1.8	Rotesco	32
4.1.2	Trace comparisons of corroded rope sample	35
4.2	Broken wire sample	36
4.2.1	Details of results: broken wire sample DS2 – 8m length	36
4.2.1.1	Noranda	36
4.2.1.1.1	Test 2 results	36
4.2.1.1.2	Test 3 results	38
4.2.1.1.3	Comments by Noranda	38
4.2.1.2	Lloyds Beal	40
4.2.1.2.1	Test 2 results	40
4.2.1.2.2	Test 3 results	42
4.2.1.2.3	Comments by Lloyd Beal	43
4.2.3.3	DMT	44
4.2.1.3.1	Test 2 results	44
4.2.1.3.2	Test 3 results	45
4.2.1.3.3	Comments by DMT	45
4.2.1.4	NDT Technologies	46
4.2.1.4.1	Test 2 results	46
4.2.1.4.2	Test 3 results	48
4.2.1.4.3	Comment by NDT Technologies	49
4.2.1.5	Universität Stuttgart	51
4.2.1.6.1.1	Test 2 results	51
4.2.1.5.2	Test 3 results	53
4.2.1.5.3	Comments by Stuttgart Universität	53
4.2.1.6	AATS	53
4.2.1.6.1	Test 2 results	53
4.2.1.6.1.1	Test 2 results – AATS instrument	53
4.2.1.6.1.2	Test 2 results – RMS instrument	55
4.2.1.6.2	Test 3 results	55
4.2.1.6.3	Comments by AATS	55
4.2.1.7	Meraster	56
4.2.1.7.1	Test 2 results	56
4.2.1.7.2	Test 3 results	57
4.2.1.7.3	Comment by Meraster	57

4.2.1.8	Rotesco	57
4.2.1.8.1	Test 2 results	57
4.2.1.8.2	Test 3 results	58
4.2.1.8.3	Comments by Rotesco	58
4.2.2	Results of test no 1	59
4.2.3	Remaining strength of section TP1	59
4.3	DMT experimental rope containing artificial defects	60
5	Analysis and discussion	60
5.1	Corroded rope sample	60
5.2	Assessment of the broken wire rope sample	62
5.3	Alternative instrument configurations	63
5.4	Effect of instrument velocity and direction on the output signal	63
5.5	Loss of breaking strength as a discard criteria	63
6	Conclusions	64
6.1	Corroded rope sample	64
6.2	Broken wire rope sample	64
6.3	General	65
7	Recommendations	65

Appendix 1: Details of the results of the NDE and destructive test of the broken wire rope sample.

Appendix 2: Summary of work funded by the Chamber of Mines and SIMRAC from 1985 to 1997.

Appendix 3: Detailed report of the destructive testing of the broken wire rope sample.

Appendix 4: Trace comparison of corroded rope sample

Appendix 5: Trace comparison of broken wire rope sample

Appendix 6: List of participants

# List of figures

		<b>Page</b>
Figure 1.1	Example of a six strand and a multi-layer, low rotation rope Construction	8
Figure 1.2	Position of broken wires within a multi-layer, low rotation rope sample	9
Figure 2.1	SMRE Test Rope Ø 38 mm – Locked coil winding rope containing artificial defects	16
Figure 3.5.1.1	Test head-to-rope airgap	20
Figure 3.5.1.2	Corroded rope sample	21
Figure 3.5.2.2	48 mm rope sample with broken wires	22
Figure 4.1.2	Trace comparison	35
Figure 4.2.1.1.1(a)	Noranda: Broken wire comparison for Test 2 at 100 mm intervals	37
Figure 4.2.1.1.1(b)	Noranda: Broken wire comparison for Test 2 at 200 mm intervals	38
Figure 4.2.1.1.3(a)	Noranda local fault trace for 48 mm fishback	39
Figure 4.2.1.1.3(b)	Noranda damage index computation over 48 mm fishback	40
Figure 4.2.1.2.1(a)	Lloyds Beal: Broken wire comparison for Test 2 at 100 mm intervals	41
Figure 4.2.1.2.1(b)	Lloyds Beal: Broken wire comparison for Test 2 at 200 mm intervals	41
Figure 4.2.1.2.2(a)	Lloyds Beal: Broken wire comparison for Test 3 at 100 mm intervals	42
Figure 4.2.1.2.2(b)	Lloyds Beal: Broken wire comparison for Test 3 at 200 mm intervals	43
Figure 4.2.1.3.1(a)	DMT: Broken wire comparison or Test 2 at 100 mm intervals	44
Figure 4.2.1.3.1(b)	DMT: Broken wire comparison for Test 2 at 200 mm intervals	45
Figure 4.2.1.4.1(a)	NDT Technologies: Broken wire comparison for Test 2 at 100 mm intervals	47
Figure 4.2.1.4.1(b)	NDT Technologies: Broken wire comparison or Test 2 at 200 mm intervals	47

Figure 4.2.1.4.2(a)	NDT Technologies: Broken wire comparison for Test 3 at 100 mm intervals	48
Figure 4.2.1.4.2(b)	NDT Technologies: Broken wire comparison for Test 3 at 200 mm intervals	49
Figure 4.2.4.3	NDT Technologies: LMA and LF traces and relative number of Broken wire $N/N_{\max}$	51
Figure 4.2.1.5.1(a)	Stuttgart Universität: Broken wire comparison for Test 2 at 100 mm intervals	52
Figure 4.2.1.5.1(b)	Stuttgart Universität: Broken wire comparison for Test 2 at 200 mm intervals	52
Figure 4.2.1.3.2	DMT – 3D scan	53
Figure 4.2.1.6.1(a)	AATS: Broken wire comparison for Test 2 at 100 mm intervals	54
Figure 4.2.1.6.1(b)	AATS: Broken wire comparison for Test 2 at 200 mm intervals	54
Figure 4.2.1.6.1.2	AATS – RMS: Broken wire comparison for Test 2 at 200 mm Intervals	55
Figure 4.2.1.7.1(a)	Meraster: Broken wire comparison for Test 2 at 100 mm intervals	56
Figure 4.2.1.7.1(b)	Meraster: Broken wire comparison for Test 2 at 200 mm intervals	56
Figure 5.5	Rope deterioration over time	63

## List of tables

Table 3.8.1	Contractual obligations – GAP503	24
Table 3.8.2	Contractual obligations – GAP 535	25
Table 4.1(a)	Corroded sample: TP1 results	25
Table 4.1(b)	Corroded sample: TP2 results	26
Table 4.2.3	Remaining strength comparison of 48 mm rope, TP1	60

# 1 Introduction and background

Many miners have died and major financial losses have been incurred over the centuries as a consequence of the catastrophic failure of mine hoisting ropes. Rope condition assessment, in the form of visual inspections, has been practised since the development of the first rope. The inspection of vegetable fibre ropes was difficult and unexpected rope failures were common. The development of stranded, iron wire ropes in the 1830's led to enhanced rope lives and made the visual inspection of ropes easier which in turn resulted in safer hoisting practices. Unfortunately in-service rope failures still occurred.

In the 20th century governments around the world passed legislation requiring operators to discard hoisting ropes which had lost a certain percentage of their original breaking strength during service. The South African Minerals Act and Regulations – section 16.33 states that “A winding rope, balance rope or tail rope shall not be used if the breaking force at ANY POINT in the rope is less than nine tenths of the original breaking load”. The aim of such legislation is obviously to enhance safety and to minimise the risk of catastrophic rope failures.

The question of establishing the remaining strength accurately at any point along a rope, using non-destructive methods, has been a point of debate for many decades.

Initially it was assumed that a direct relationship existed between the loss of steel area in a rope due to wear and broken wires, and the breaking strength of the rope. Numerous rules and guidelines were drawn up to assist operators to determine when a rope had come to the end of its useful life. Initially all assessments were based on visual examinations and physical measurements of the rope.

In 1906 the first patent was issued to McCann and Colson for a magnetic rope test instrument in Germany. The development of instruments to non-destructively test ropes has continued to this day in various countries around the world.

In 1956 Semmelink reported that the actual breaking strength of ropes was different to the breaking strength determined by using magnetic test instrument results<sup>1</sup>. Harvey and Kruger conducted experiments during the 1950's in South Africa to establish the effects of cut wires, loss of steel area and corrosion on the breaking strength of ropes<sup>2</sup>. This work, published in 1959, formed the basis for rope condition assessment in South Africa for the next 30 years.

In the 1980's mining houses in South Africa started assessing ways of hoisting greater tonnages from existing facilities as well as hoisting economical payloads from very deep shafts. One of the issues raised during these investigations was the efficacy of current rope condition assessment globally and particularly in South Africa. Further investigation indicated that no common standard existed in this country for rope condition assessment and that the remaining strength of discarded ropes varied greatly. This indicated the need for a South African standard for rope condition assessment.

Numerous projects were funded, initially by the Chamber of Mines, later by SIMRAC, which addressed mine hoisting ropes in general and the condition assessment and discard criteria of ropes, particularly six stranded ropes. See Appendix 2 for details.

Note: The majority of winding ropes employed in the South African mining industry are of the six-stranded construction.

Some of this work culminated in the publication of the SABS 0293: 1996: Code of Practice: Condition Assessment of Steel Wire Ropes on Mine Winders. This code is now applied throughout the South African mining industry by rope inspectors certificated in terms of the code by the South African Qualification and Certification Committee (SAQCC). Application of the code has led to enhanced safety and a reduction in operating costs.

Parallel research has indicated that six stranded rope constructions, so commonly used in South Africa, may not be suitable for hoisting from great depths and that multi-layer, low rotation ropes may be required for this application.

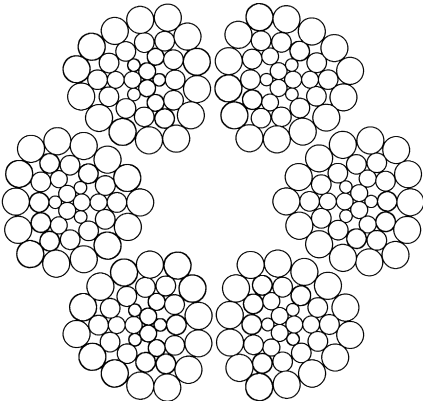

Six strand rope construction

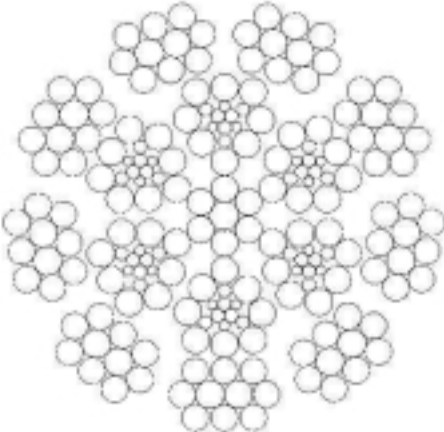

15 strand, multi-layer, low rotation, fishback rope construction

**Figure 1.1 Example of a six strand and a multi-layer, low rotation rope construction**

Rope trials, funded by the Anglo American Corporation of South Africa Limited, Gold Division, employing four, 48 mm diameter, low rotation, 15-strand fishback ropes were conducted at Vaal Reefs 9# during the period December 1990 to April 1993. These ropes were non-destructively tested at monthly intervals. In the final report relating to this rope trial the following was stated: *“Internal deterioration was suggested by anomaly indications appearing where no rope outer wire fractures were visible. Since the nature of this deterioration was unknown the condition of the ropes could not be assessed accurately on the basis of the non-destructive, magnetic rope tests”*.<sup>3</sup>

Numerous samples were cut from the ropes after discard. Three pieces cut from these samples were de-stranded to ascertain the actual condition of the ropes. It is interesting to note that no broken wires had occurred on the 9 outer strands of any of the rope samples. *It was however disturbing to find 148 broken wires on the inner six strands of two of the 2-m long samples. In one sample 21 broken wires were found in an axial rope length of 100 mm. Figure 1.2 indicates the positions of the broken wires.*



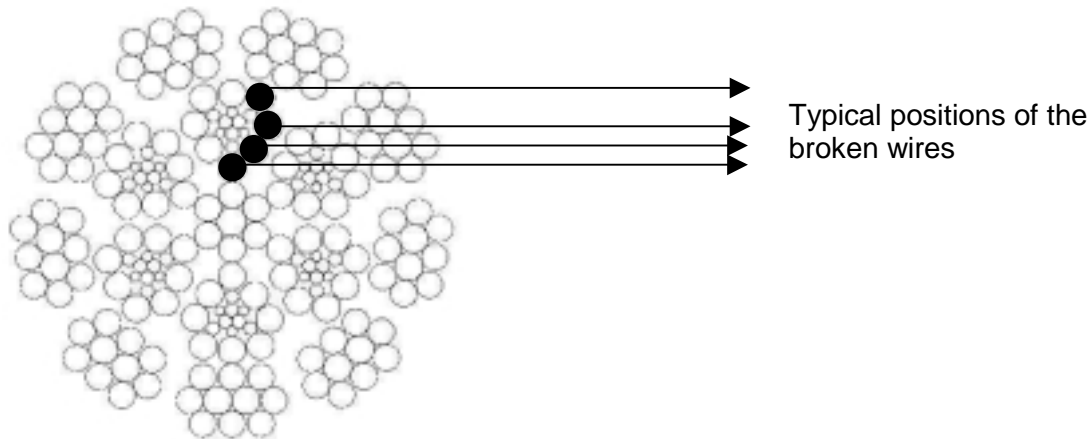

**Figure 1.2 Position of broken wires within a multi-layer, low rotation rope sample**

These results clearly indicated that the non-destructive testing methods employed by the South African mining industry at that time were not able to detect broken wires located on the inner strands of multi-layer ropes.

This has serious implications for operators employing or wishing to employ multi-layer, low rotation ropes in hoisting shafts.

In its current form SABS: 0293: 1996 does not adequately describe discard criteria for multi-layer, low rotation ropes. The reason for this is that the in-depth knowledge regarding this type of rope construction was not available during the drafting process of this code. The GAP324 Volume 1, GAP 439 and GAP 502 projects are aimed at establishing and defining discard criteria for such multi-layer, low rotation ropes.

It must be noted that the effective application of these discard criteria in the condition assessment of multi-layer, low rotation ropes is based on the premise that broken wires, on the inner strands of the rope, can be identified accurately by non-destructive testing methods as applied in the field.

The results of the Vaal Reefs 9 shaft experiment, mentioned above, cast doubt on the effectiveness of using non-destructive testing techniques and the discard criteria established in GAP 502 for the effective condition assessment of multi-layer ropes.

Representatives from the mining industry debated the problem and subsequently forwarded a proposal to SIMRAC. The proposed project focussed on ascertaining the defect detection capabilities of magnetic rope test instruments in respect of multi-layer, low rotation rope constructions on an international basis. This resulted in the project GAP 503 with the title "Magnetic Rope Testing Performance" which commenced in January 1998.

During the course of the project the GAP(EAG) advisory committee identified the opportunity of including the non-destructive testing of a corroded, multi-layer, low rotation rope into the programme. Accurate condition assessment of corroded, six stranded ropes has been problematic and the procedure for testing such ropes is laborious and time consuming. The advisory committee deemed it to be an ideal opportunity to request expert rope inspectors from around the world to non-destructively establish the remaining strength of a corroded, multi-layer, low rotation rope sample. A second contract, GAP 535, was awarded to the researcher during May 1998 to pursue this work.

This document reports on the methodology employed during the project, the results, conclusions and recommendations.

## 1.1 Problem statement

The South African mining regulations call for winding ropes, balance ropes or tail ropes to be discarded if the breaking force at ANY point in the rope is less than nine tenths of the original breaking load.

### 1.1.1 Rope condition assessment in terms of broken wires

Research over the past 12 years has culminated in the SABS: 0293: 1996. Application of this code has had a marked impact on meeting the requirements of the regulations for six stranded, single layer ropes.

Current indications are that six stranded rope constructions are not suitable for deep hoisting applications and that multi-layer, low rotation type ropes will be required for these applications.

Recent SIMRAC funded research has led to the formulation of discard criteria for multi-layer, low rotation ropes which are to be incorporated into a revision of the SABS: 0293. **The basic premise on which the condition assessment of multi-layer, low rotation ropes is based is that magnetic rope test instruments are capable of detecting each broken wire (both externally and internally) within such rope constructions.**

Results of a trail of multi-layer, low rotation ropes during the period 1990 to 1993 indicated that magnetic rope test instruments employed in South Africa during this time were not able to identify internal broken wires within this type of rope construction.

This impacts on the safety of installations using such rope constructions as accurate condition assessment of such ropes is not possible. The requirements of the Regulations, Section 16.33 are also not met.

### 1.1.2 Rope condition assessment in terms of corrosion

Effective rope condition assessment of corroded six stranded ropes is a time consuming and laborious process. Little information is available to determine the remaining strength of multi-layer, low rotation ropes which exhibit corrosion.

## 1.2 Objectives of this study

### 1.2.1 Main objective

The main objective of this study is to enhance the safety of winding installations employing multi-layer, low rotation rope constructions by establishing the defect detection capabilities of magnetic rope test instruments, on a world wide basis, to identify broken wires within such ropes.

The second main objective is to establish the accuracy to which rope inspection authorities world-wide, are able to predict the remaining strength of a corroded section of a multi-layer, low rotation rope. This too can lead to enhanced safety in hoisting installations.

## **1.2.2 Other objectives**

### **1.2.2.1 Awareness of instrument limits**

An further objective of this study is to make rope inspectors aware of the capabilities of the instruments being used, especially the limitations of the instruments employed. This knowledge is crucial in the execution of a rope inspectors duties.

### **1.2.2.2 Revision of the SABS: 0293 Code of Practice**

SABS: 0293 addresses the discard criteria for multi-layer, low rotation ropes only very superficially. An objective of this study is to provide the information necessary to enhance the current document.

### **1.2.2.3 Feedback to rope instrument manufacturers**

Another objective is to provide feedback to magnetic rope instrument manufacturers and suppliers regarding the defect detection capabilities of their instruments. It is expected that this information will lead to the enhancement of instruments in the long term and hence improvements in rope inspection and rope condition assessment.

### **1.2.2.4 Contribute to the knowledge pool for rope condition assessment.**

It has been said that rope condition assessment is more of an art than a science. This work will contribute to the knowledge base of rope condition assessment and hence a better understanding of the subject.

## **1.3 Research methodology**

### **1.3.1 Broken wire detection (GAP 503)**

During the early stages of the project a number of different methodologies were identified to establish the broken wire detection capability and resolution of various instruments. After due consideration it was decided to obtain a rope sample from a discarded rope from the field, with an unknown number of broken wires, and to contract various well known wire rope non-destructive examination experts to examine the sample in great detail. Inspectors were tasked to examine the rope sample in terms of a laid down procedure. After the initial examination, inspectors were given the opportunity to examine the rope sample in any other way employing non-destructive means.

After the non-destructive examination an expert destranded the rope sample and established the exact position of each wire break.

The NDE results from the various inspection authorities were then compared with the actual location of each broken wire identified in the rope sample to establish a correlation between the broken wires identified by means of non-destructive testing methodologies and the actual broken wires in the rope. By this means it was hoped to establish the resolution of various instruments to detect internal broken wires.

Eight non-destructive rope testing authorities (two from Canada – Rotesco and Noranda, one from the USA – NDT Technologies, one from the UK – Lloyds Beal, two from Germany – Stuttgart University and DMT, one from Poland – Meraster and one from RSA – AATS, were contracted to perform the non-destructive examination of the rope sample. Haggie Rand Limited was contracted to physically dismantle the rope and to record each broken wire.

### **1.3.2 Remaining strength estimate of a corroded rope (GAP 535)**

The eight rope testing authorities were also contracted to non-destructively examine a rope sample which was generally in a good condition except for an approximately 3,5 m long section which was heavily corroded. The contract required that the inspection authorities had to establish the remaining strength of a good section of the rope as well as the corroded section.

After the NDE the two sections were cut from the rope sample and destructively tested by the CSIR rope testing laboratory in Cottesloe to establish the remaining strength of the two rope sections.

The actual rope strengths were then compared to the predicted values to establish a correlation.

## **1.4 Deployment of the study**

Section 1:	Introduction and background
Section 2:	Literature search results
Section 3:	Research methodology
Section 4:	Results of the experiment – non-destructive examinations vs actual condition of the rope
Section 5:	Analysis and discussions
Section 6:	Conclusions
Section 7:	Recommendations.

## **1.5 Scope of the study**

The study was limited to establishing the ability of 8 expert non-destructive rope testing organisation to identify the broken wires present within a multi-layer, low rotation rope sample as well as the remaining strength of a corroded rope sample.

These results were then to be used in establishing the resolution of the various instruments to detect internal broken wires.

# **2 Literature search**

## **2.1 Background**

Although not part of the contract, a literature search was conducted to establish the current status of NDE of ropes.

A great deal has been written about ropes and the non-destructive examination of ropes. Searches were conducted on the world wide web resulting in a limited number of publications being identified.

The greatest source of information is contained in the OIPEEC (Organisation Internationale Póur L'Etude De L'Endurance des Cables) bulletins. The OIPEEC bulletins contain regular reviews of internationally published wire rope publications and are compiled by Dr Isabel Ridge and Prof Richard Chaplin of the University of Reading. Summaries of papers dating from January 1993 to 1999 were scanned.

The researcher also visited various overseas institutions in an attempt to obtain information regarding the discard criteria and non-destructive examination of multi-layer low rotation ropes.

Close contact is also maintained with South African organisations and persons involved in rope NDE and rope research.

## 2.2 Literature search results

Numerous papers regarding rope non-destructive examination, by authors from Poland, Canada, USA, China, France, Germany, South Africa and Italy, have been presented over the past years. Papers cover the development of new algorithms, neural networks theories to detect and enhance the sensitivity of instruments to detect and size internal broken wires, theoretical analyses, standards and practical guidelines for rope NDE and a number of theoretical treaties.

Four PhD theses (from Stuttgart University <sup>4,5,6</sup> and one from RAU <sup>7</sup>) regarding non-destructive rope testing were reviewed.

The above work shed little light on the actual detection capabilities of instruments for multi-layer, low rotation ropes.

A paper published in the CIM Bulletin of December 1990 by the authors Geller and Udd titled "How accurate are non-destructive testing based estimates of mine shaft rope breaking strength losses? Up date" reports the following:

- While there is no doubt that improved safety has resulted from the mandatory use of these EM wire-rope testers, several factors contributed to CANMET's decision to undertake an extensive review of the relative performance levels of a range of EM instruments
  - \* failures continued to occur in wire ropes that had been routinely tested....
  - \* an in depth study had not been undertaken before ....
- The principle objective was to evaluate comparatively the level of accuracy with which loss of breaking strength (LBS) in mine shaft ropes can be estimated on the basis of non-destructive testing with EM instruments.
- A range of rope sizes (from 7/8 in to 2¼ cm) and constructions were tested both in situ and on the shop floor. In addition, special test ropes with artificial defects were designed and fabricated.
- .... it was concluded that, at the time of removal, many mine shaft ropes had lost much more of their original breaking strength than had been estimated on the basis of EM testing, or than had been allowed by the regulations.
- **The authors believe the results are a consequence of the great complexity of the NDT estimating routine as a whole.**
- The essential factor of success, in the author's opinion, involves the presence in the field of a thoroughly competent and committed operator with a thorough understanding of
  - (i) the procedures to be followed
  - (ii) the technical and operational background of the ropes to be tested
  - (iii) the basic physical and operational characteristics of the EM instrument being used.
- The paper concludes that: "the desired accuracy level has not been attained"<sup>8</sup>.

A paper titled "Inspection of Wire ropes for offshore Applications" by Weischedel and Chaplin – March 1991 reports as follows:

- In contrast (to visual examination) electromagnetic inspection can detect and measure external and **internal** rope deterioration quickly and is not impeded by mud or marine

growth ... EM inspection of offshore ropes promises significant savings by extending safe service life and avoiding rope failures.

- The inspector of torque-balanced, multi-strand ropes (used for offshore cranes and diving bells) faces a dilemma. In these multi-layered constructions, the combined effects of interwire and innerstrand nicking, fatigue, corrosion and lubricant degradation can produce rapid internal deterioration. If undetected, this can lead to very dangerous situations. Because internal deterioration commonly occurs with no externally visible signs visual inspection becomes ineffective.
- EM wire rope inspection gives **detailed** insight into the condition of a rope. Its reliability has made EM testing a universally accepted method for inspection of wire ropes in mining and other applications .....
- EM inspection of multi-strand ropes:
  - As discussed above, multi-strand ropes can develop serious internal deterioration that cannot be detected by visual inspection ....
  - EM inspection can detect external as well as internal rope deterioration and can replace the present, inherently wasteful, statutory life policy with a more rational and economical retirement - for cause approach.<sup>9</sup>

The same authors made similar statements to the above in a paper titled "The inspection of offshore wire ropes: the state-of-the-art" at the Offshore Technology Conference in May 1992.

The paper adds the following:

- .... multi-strand ropes are prone to develop internal broken wires. This break-up occurs primarily on the interface between the outer and second layer of strands, usually with no externally visible signs.
- Corrosion is a serious hazard to a wire rope ....
- EM inspections help the inspector in several ways:
  - (i) they assist in identifying visible local flaws ....
  - (ii) they can identify hidden internal damage.
- These ideas are generally being accepted by the wire rope community. For example, the proposed US Code of Federal regulations uses LMA to formulate retirement criteria. The Lloyd's Code for Lifting Appliances recognises the value of EM inspection in discard criteria.<sup>10</sup>

Herbert R Weischedel was the author of numerous other papers published between 1985 and 1997. Extracts follows:

- While all modern LMA/LF instruments offer greatly improved testing reliability as compared to previous state of the art, main flux instruments have superior resolving power, which makes interpretation easy and very reliable.<sup>11</sup>
- EM rope inspections are valuable and cost effective .... However, the use of wire rope test instruments with insufficient resolution (or low inspection accuracy) leads to premature rope retirement .... More over, insufficient resolution can cause dangerous rope operating conditions. Rope testers with better inspection accuracy (or resolution) minimise these problems.<sup>12</sup>.

- .... the US Mine Safety and Health Administration (MSHA) has performed many carefully conducted field and laboratory investigations using LMA-Test™ instrumentation. These experiments have demonstrated that, because of their superior quantitative resolution, rope testers from the LMA-Test™ series usually show the true rope condition with sufficient accuracy, well within the accuracy limits of the entire EM wire rope inspection method. In other words, for LMA-Test™ **instruments a correction factor of “1” can be used, and the LMA reading can be directly used as the loss-of-strength estimate.**<sup>14</sup>.

The above literature indicates that instruments are commercially available which exhibit high resolution which result in acceptable non-destructive rope inspection results.

At the Mine Hoisting 93 Conference in London the following was reported: “In conclusion it may be said that the goals of both the 1986 - 1990 CANMET projects, and those of the 1990 – 1992 follow up work, undertaken jointly by CANMET and NORANDA, have been met. It was confirmed that inspections with EM instruments is a practical and reliable technique for non-destructive testing of wire ropes. It was also found that while instruments per se, operated very satisfactorily within their physical design given limitations, some 30% of the reported results were considered to be unacceptable. In general, the relevant problems were related to:

- (a) difficulties with the instrument’s setting up procedure
- (b) chart-evaluation related difficulties
- (c) lack of well founded algorithms for converting the instruments’ LMA and LF data into reliable LBS estimates.

Several recommendations were made to overcome these difficulties. Some have already been acted upon, such as:

- (a) the finite element analysis of a permanent magnet cum Hall-sensors head’s operational characteristics leading to
- (b) the computerisation of such an instrument’s calibration and general signal processing functions”<sup>15</sup>.

A paper published in NDT Solutions – during March 1998 states that new computerised techniques allows the amplitude of LF signals to be linked to specific ropes and specific wire breaks. “On the basis of theoretical considerations and laboratory testing, it could always be shown that LF signals shape and amplitude are functions of several basic parameters, including the rope’s weight and size, the broken wire’s size and the location within the rope, and the gap size of the break. With the computerised system the history of the signal voltages during the entire test process can now be recorded and displayed. Therefore, the influence of the parameters can be quantified ..... The same type of tests can be performed for the LF signal patterns in the field, thus establishing quantified benchmarks for very specific rope sizes and constructions, for specific anomalies and corrosion severity, and for quite specific operational conditions. These LF patterns are known to be remarkably consistent and repeatable.”<sup>16</sup>.

Martyna comments that “the magnetic leakage fields for faults located close to one another have a disturbing influence on one another.... The result of measurements for faults situated close to one another is smaller than the sum of the results for distributed faults of wires”.<sup>17</sup>.

In a paper at the OIPEEC Round Table in 1997 Hamlin stated “the LF base signals get progressively “noisier” as the wire rope ages with the increasing number of fatigue cycles. The LF chart visually indicates the degradation of the rope, but it is hard to draw clear conclusions from it, as to the remaining service life of the wire rope in question.”<sup>18</sup>.

In the late 1970's early 1980's, the Health and Safety Laboratory in Sheffield, an agency of the United Kingdom's Health and Safety Executive, conducted tests on full lock coiled ropes with artificial defects. The aim of the project was to establish the resolution of various instruments at that time. Grooves were cut into the wires of a layer, to half the wire diameter, as indicated in figure 2.1.

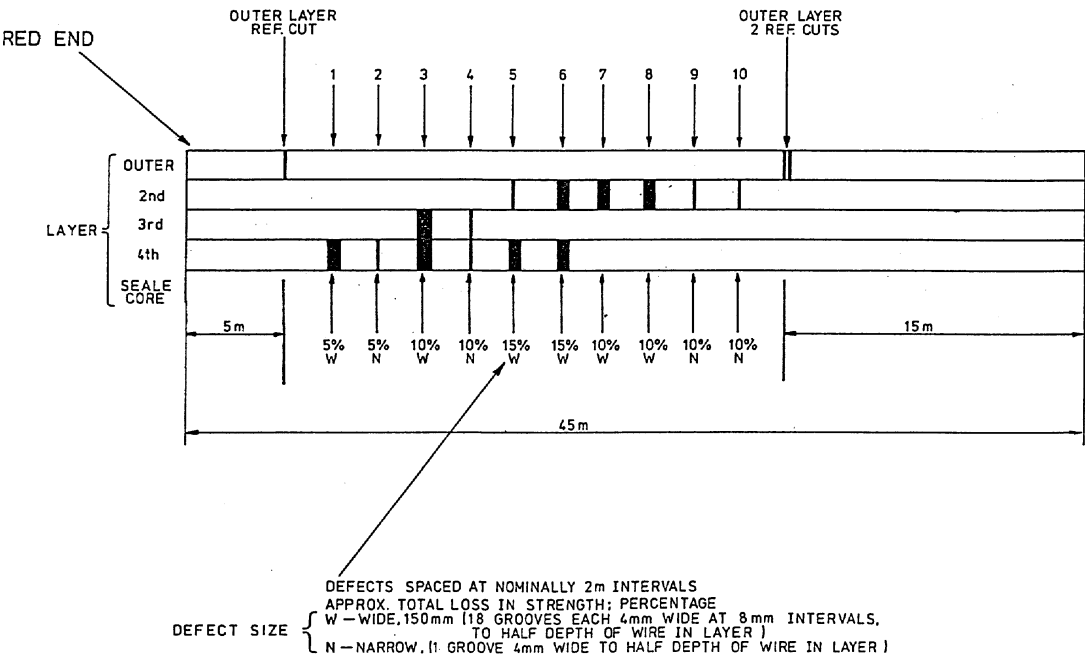

Fig. 5.2 Diagram showing artificial defects in the SMRE Test Rope

**Figure 2.1 SMRE Test Rope Ø 38 mm – Locked coil winding rope containing artificial defects**

Seven rope test instruments were used in the trial. Dr Christopher H H Corden related to the researcher at a meeting in the United Kingdom, that the instruments were not able to identify each anomaly accurately. Only a German instrument using a very small airgap, was successful in identifying most of the defects. It is however impractical to use such small airgaps in the field. The researcher was unfortunately unable to obtain a copy of the final report.

**2.3 Conclusion drawn from the literature survey**

Of the literature surveyed little reference was found to the actual resolution obtained by magnetic rope test instruments in the non-destructive testing of multi-layer, low rotation ropes.

While some of the papers suggest that internal broken wires can be identified accurately by means of magnetic rope test instruments, others seem to indicate that this is problematic, especially where a multitude of broken wires exist within a multi-layer, low rotation rope.

Similarly there are varying opinions regarding the remaining strength of corroded ropes. In some quarters there is the belief that sophisticated algorithms built into the instruments can lead to accurate predictions of the condition of corroded ropes. There are claims that LMA readings of



highly sophisticated instruments can be used directly to estimate the loss-of-strength of ropes. On the other hand different authors are of the opinion that it is very difficult, if not impossible, to predict the remaining strength of ropes. These experts propose different discard criteria based on loss of metallic area of the ropes.

The literature survey clearly indicated that there is no simple solution to the accurate identification of internal broken wires and the estimation of remaining strength of multi-layer, low rotation ropes.

The literature survey indicated to the researcher that the only way of establishing the resolution of magnetic rope test instruments with regard to multi-layer, low rotation ropes was to conduct a controlled experiment in which world experts were tasked to non-destructively examine rope samples and then to physically determine the actual number of internal broken wires and the remaining strength of the rope by destructive tests.

## **3 Research methodology**

### **3.1 Choice of methodology**

The basic methodology proposed for the experiment was to fit a rope sample into a tensioning device and to then have the rope examined non-destructively in great detail by various rope inspectors. After the non-destructive examinations had been completed the rope would either be destranded into its individual components to establish the position of each broken wire or destructively tested to ascertain its remaining strength. The NDE results would then be compared to the actual condition of the rope sample to establish the detection capabilities and resolution of the instruments.

There are several variations in choosing the rope samples for the test and conducting the non-destructive rope examination.

In the choice of rope sample the researcher could either employ a discarded rope from the field with an unknown distribution of internal broken wires or corrosion, or alternatively request a rope manufacturer to produce a rope sample with known internal defects.

The manufacture of rope samples with known defects is possible but time consuming. The resultant defects are manufactured and not necessarily a replica of the wire breaks experienced under operating conditions. The choice of rope sample was discussed at a GAP(EAG) meeting and it was unanimously decided that rope samples from the field should be employed.

Furthermore, the non-destructive examination could either be conducted by an expert using his own instrument and performing the analysis of the instrument output signals himself whereafter the expert would submit a detailed report regarding the condition of the rope sample, or the researcher could subject each instrument to a series of pre-defined tests and then analyse the outputs from the various instruments and draw conclusions for each instrument tested.

From the literature survey it is quite clear that the efficiency of rope NDE is to a large degree dependant on the technician using the instrument and his experience plus understanding of the instrument. It was therefore decided to contract world class rope NDE experts to conduct the examinations and for them to submit detailed reports.

## 3.2 Choice of NDE experts

Initially seven organisations were identified as having expert knowledge in the field of rope NDE. Several of these organisations produce the rope test instruments used for the examinations as well. Most have produced several papers in the field of rope NDE and have conducted research in this field. The SIMRAC contract was concluded on the basis of having seven organisations participate in the experiment.

The following were invited and accepted:

- (i) NORANDA, from Canada, were intimately involved in the CANMET/NORANDA funded rope-testing project between 1986 and 1992. NORANDA also supplies rope testing instruments to the mining industry. Employees of these organisations have published a large number of papers on rope inspection.
- (ii) Lloyds Beal Limited, from the United Kingdom. This company bought the rope testing unit and expertise from the Mines Health and Safety Executive several years ago. Lloyds Beal is responsible for examining the hoisting ropes in the UK mining industry. The chief inspector has published papers regarding rope NDE.
- (iii) DMT – Gesellschaft für Forschung and Prüfung, from Germany are responsible for the NDE of all mine hoisting ropes employed in Germany and the DMT produce their own instruments. A number of papers have been presented at international conferences by staff members.
- (iv) NDT Technologies, Inc from the USA, have produced and sold instruments to the USA armed forces and rope users world-wide. Dr Weischedel has authored numerous papers published in the international rope inspection arena.
- (v) Universität Stuttgart – Institut für Fördertechnik, from Germany tests ropes on ski lifts, cable cars and cranes. A number of papers and PhD theses have been published under the auspices of the university regarding rope NDE. This organisation also produces and sells its own instruments.
- (vi) AATS – from South Africa, test a large number of ropes in the Southern African mining and other industries. Personnel have presented papers at international conferences and AATS made a significant input into the SABS Code of Practice for rope condition assessment. This organisation also produces rope test instruments.
- (vii) The University of Mining and Metallurgy in Cracow, Poland. Dr Tytko and the University have conducted numerous studies into effective rope condition assessment and assist in rope condition assessment in Poland.

Dr Tytko withdrew from the project during the year because of high workload. The Polish instrument supplier Meraster was identified as a substitute.

During discussions with the GAP(EAG) committee the researchers were requested to include the Rotesco company as well. This request was accommodated with no increase to the contract value.

- (viii) Meraster from Poland are a well known manufacturer of rope test instruments having supplied instruments to Poland, England, Australia and Zambia.
- (ix) Rotesco Inc from Canada supply rope test instruments to the market and have provided rope condition assessment service to the mines for the past 30 years.

Contracts were placed on the eight organisations mentioned above to conduct rope condition assessments on a multi-layer, low rotation rope with internal broken wires as well as a multi-layer, low rotation rope with severe corrosion. The contractors were provided with all the relevant rope details and test procedures long before the tests commenced.

### **3.3 Choice of testing laboratory**

Several test facilities were identified in Europe, South African and the United Kingdom. The researcher decided to conduct the experiment at the DMT – Testing and Transport Technology Laboratories in Bochum, Germany because two tensile testing machines of suitable capacity and length were available in one hall at the DMT at a reasonable fee. This facility allowed the NDE to progress in quick succession. The location is also convenient from a logistics point of view. Four of the NDE organisations were able to travel by car to Bochum.

The two rope samples of approximately 18 m length could be accommodated in the tensile testing machines and pre-tensioned to the correct values.

Facilities were installed at both tensile test benches which allowed the test heads to be pulled back and forth over the ropes at various pre-determined speeds in a controlled manner.

### **3.4 Choice of rope samples**

As stated earlier, it had been decided to employ discarded rope samples from the field for the experiment.

#### **3.4.1 Corroded rope sample**

The researchers were able to source a unique 36 mm diameter, 21 strand – 21 (9 x 6 x 6) construction, multi-layer, low rotation rope of some 23 m length in very good condition except for an approximately 3 m length exhibiting heavy corrosion. This was an ideal sample because there were no broken wires in the sample and the bulk of the rope was in excellent condition, allowing for the calibration of the instruments on a good portion of the rope.

#### **3.4.2 Broken wire rope sample**

There were a number of 48 mm diameter, 15 strand 9 x 10 (8/2)/6 x 14 (8/6 + 3T)/WMC fishback, low rotation, multi-layer rope samples available from the experiment conducted at Vaal Reefs number 9 shaft during the period 1990 to 1993. Details of the rope and the winding plant are stated in Appendix 3, in the report prepared by M Borello of Haggie Rand.

After discussions with experts in the rope testing field and taking cognisance of the information obtained in the literature search, the researcher decided to use a rope sample exhibiting the least amount of damage. In theory, the fewer the number of clusters of broken wires contained within the rope under test the better the chances of accurate detection of the broken wires.

The rope samples were examined, non-destructively, in great detail by AATS rope inspection personnel at the CSIR premises at Cottesloe. The “best” rope sample, showing the least number of internal broken wires and “noise”, was identified and prepared for shipping to Bochum.

The two samples were airfreighted to Germany for preparation and installation into the two tensile testing machines.

## 3.5 Test procedures

### 3.5.1 Corroded rope sample

The 36 mm diameter rope was installed into the tensile testing machine and pre-tensioned to 9,6 tons, which is 10% of the ultimate breaking strength of a new rope. The reason for tensioning the rope is to simulate rope conditions in-service.

Each contractor was required to fit his instrument to the rope and prepare for the following tests:

#### 3.5.1.1 Test 1:

The contractor was required to obtain instrument traces of the rope, using a minimum instrument to rope air gap of 5 mm, as depicted in figure 3.5.1.1 for the following conditions:

- (a) At an instrument velocity of 0,5 m/s in both directions
- (b) At an instrument velocity of 1,5 m/s in both directions
- (c) At an instrument velocity of 2,0 m/s in both directions
- (d) At an instrument velocity of 2,5 m/s in both directions

The traces were to be handed to the researcher directly after the test.

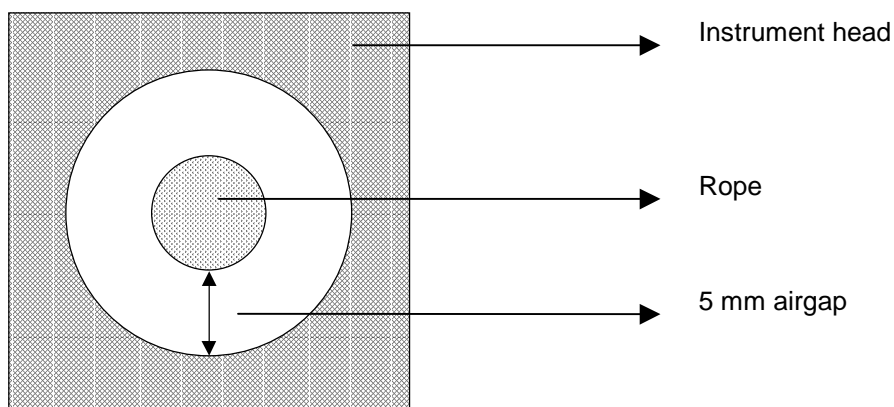

**Figure 3.5.1.1 Test head-to-rope airgap**

The reason for this test is to establish the differences, if any, of instrument output at various velocities and in different directions. Any differences could have an effect on the final interpretation of the rope condition.

The 5 mm air gap was specified in order to simulate real conditions in the field. Ropes installed on double drum winding plants are generally covered with a thick layer of rope dressing.

#### 3.5.1.2 Test 2:

The rope sample, some 21 metres in length, had a magnetic marker consisting of one 1,72 mm diameter wire, 50 mm long taped 5,35 m from one end of the rope. The wire was of the same tensility and composition as the steel used in the rope. Two portions of the rope sample, each 3,75 m long were marked off. The one portion was in the good section of the rope (test piece 1 or TP1) while the other covered the badly corroded section (test piece 2 or TP2). See Figure 3.5.1.2 for details.

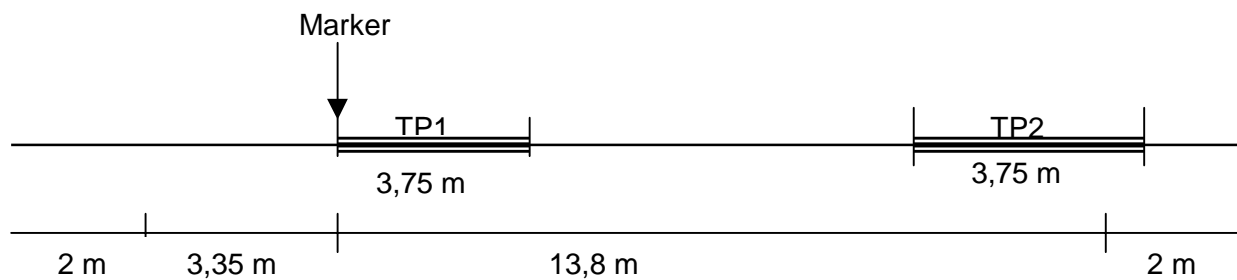

**Figure 3.5.1.2 Corroded rope sample**

The contractors were required to establish the remaining breaking strength of the rope at TP1 and TP2, where TP1 should reflect a breaking strength very close to the breaking strength of the new rope.

The contractors were also required to give an indication of the methodology employed during the test to establish the remaining strength of the rope and to substantiate the remaining strength estimates with calculations, calibration procedures, instrument traces, etc.

The contractors were further requested to comment on the effectiveness of using the remaining strength, as determined by non-destructive testing methods, as a criteria for rope discard. If possible, the contractors were to propose and substantiate a more effective method and discard criteria for the analysis of corroded ropes.

### 3.5.2 Broken wire rope sample

The 48 mm diameter rope was installed into the tensile testing machine and pre-tensioned to 20,8 ton (15% of the ultimate breaking strength of the new rope).

Each contractor was required to fit his instrument to the rope and prepare for the following tests:

#### 3.5.2.1 Test 1:

The contractor was required to obtain instrument traces for the rope, using a minimum instrument to rope air gap of 5 mm for the following conditions:

- (a) At an instrument velocity of 0,5 m/s in both directions
- (b) At an instrument velocity of 1,5 m/s in both directions
- (c) At an instrument velocity of 2,0 m/s in both directions
- (d) At an instrument velocity of 2,5 m/s in both directions

The traces were then to be handed to the researcher.

The same reasons as described above apply to this test.

#### 3.5.2.2 Test 2:

The rope sample, approximately 18 m in length, had a magnetic marker consisting of 2 mm diameter wires (of the same grade of steel as used in the rope), 300 mm in length with a gap of 25 mm between the wires taped to the rope at a distance of approximately 6,8 m from one end of the rope. The contractors were instructed to reference all broken wires identified in the rope by the NDE to the centre of this marker.

Three sections of the rope were marked off for specific analysis (see figure 3.5.2.2 for clarity).

- (a) From the left termination a section of 700 mm in length, defined as DS1 (destrand section 1).
- (b) To the right of DS1 a 3,75 m section was marked off and named TP1 (test piece 1) and
- (c) Immediately to the right of TP1 an 8 m long section was marked off and defined as DS2 (destrand section 2).

Contractors were required to examine the marked off sections of the rope in great detail using NDE methods. Again an airgap of at least 5 mm was specified. Contractors were however allowed to use any instrument velocity deemed necessary to conduct their tests.

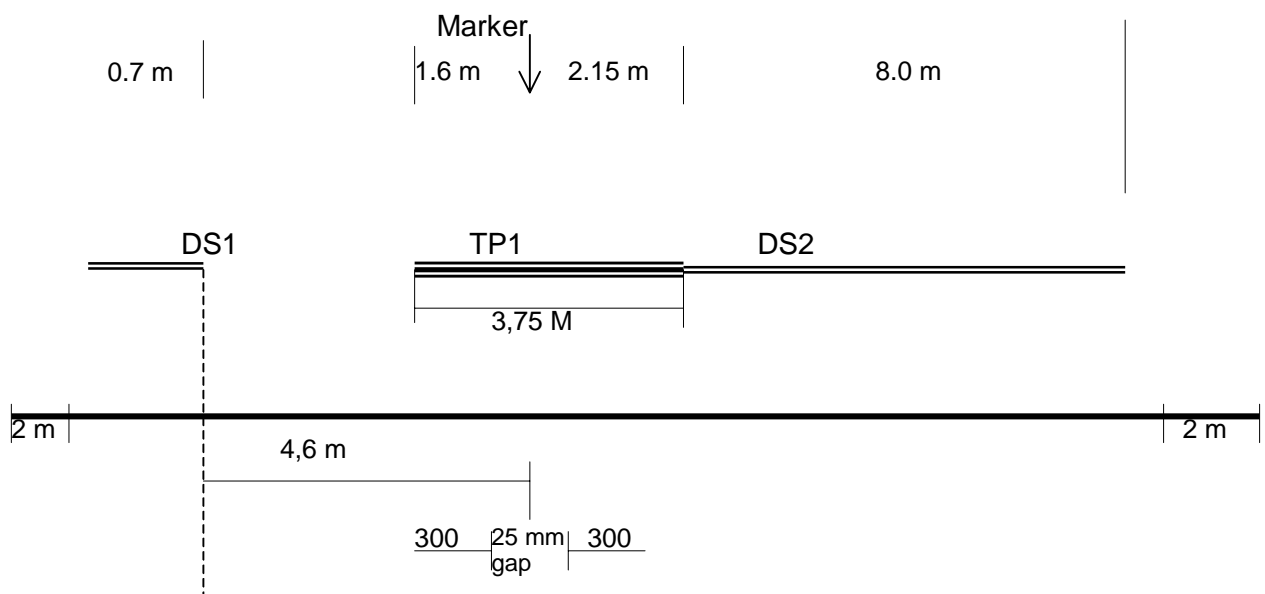

**Figure 3.5.2.2 48 mm rope sample with broken wires**

After the examination at Bochum, contractors were required to analyse the data and submit a report to the researcher by 28 September 1998 detailing the position and the number of broken wires identified in the rope, referenced to the centre of the marker for sections DS1 and DS2.

The contractors were also requested (not a contractual obligation) to submit the estimated remaining strength of section TP1).

### **3.5.2.3 Test 3:**

As indicated in the literature search, smaller airgaps and other coil configurations can produce a higher resolution.

In the third test contractors were allowed, if they so wished, to non-destructively examine the rope in any other way they wanted to in order to enhance the results of the examination. Those contractors making use of this opportunity were requested to submit a detailed report to the researcher by 28 September 1998 detailing the position and the additional number of broken wires identified in DS1 and DS2 as well as the instrument configuration used, ie the airgap, test head speed, coils, etc during this test.

## **3.6 Actual physical condition of the ropes**

After the NDE tests had been completed in Germany the ropes were flown back to South Africa for destructive examination.

### **3.6.1 Destructive test of corroded rope sample**

The corroded rope sample was forwarded to Mike van Zyl Incorporated for cutting, preparation and destructive testing.

### **3.6.2 Destranding and destructive testing of broken wire sample**

The broken wire rope sample was sent to Haggie Rand Limited for analysis.

TP1 was destructively tested to establish the remaining strength of this particular rope section.

DS1 and DS2 were destranded to establish the exact position and number of broken wires within these samples.

## **3.7 Analysis**

Once the reports from the NDE experts and destructive testing organisations had been received the researcher compared the results obtained by NDE to the actual condition of the rope as established by destructive testing.

## **3.8 GAP 503 and 535 contractual obligation**

In terms of the contracts the researcher was required to meet the obligations as listed in table 3.8.1. and 3.8.2.

### 3.8.1 Contractual Requirements – GAP 503

NO OF ENABLING OUTPUT	STEP NO	METHODOLOGY TO BE USED TO ACCOMPLISH THE ENABLING OUTPUT
1	1	Prepare test rope and ship to the UK or German rope laboratory for installation in a test bed
	2	The testing of the rope by various local and international RCA inspectors using different instruments and techniques (2 x German, 1 x Polish, 1 x Canadian, 1 x South African, 1 x USA, 1 x UK)
	3	The submission by each testing team of a comprehensive and very detailed report indicating all anomalies found in the rope by non-destructive methods.
2	1	Return the rope to RSA.
	2	Open the rope sample in a laboratory. Each strand and each wire will be examined in detail and the position of each anomaly along the axial length of the rope will be recorded.
	3	A comprehensive report will be submitted regarding the position of each anomaly.
3	1	The anomalies reported by the RCA inspectors will be compared in detail to the actual anomalies found in the rope.
	2	Conclusions will be drawn for each instrument in terms of its detection capabilities and resolution.
4	1	Final report will be submitted containing: <ul style="list-style-type: none"> <li>• An objective assessment of the fault detection capabilities and resolution of the various instruments.</li> <li>• An analysis of the limitations of current instruments and recommendations to RCA inspectors.</li> <li>• Recommendations to instrument suppliers to enhance the detection capabilities of their instruments.</li> <li>• Recommendations to the CSIR who are developing discard criteria for multi-layer ropes regarding RCA instrument capabilities.</li> <li>• Recommendations to SABS to revise and enhance the RCA Code of Practice – SABS 0293:1996.</li> </ul>

**Table 3.8.1 Contractual obligations – GAP503**

### 3.8.2 Contractual requirements – GAP 535

NO OF ENABLING OUTPUT	STEP NO	METHODOLOGY TO BE USED TO ACCOMPLISH THE ENABLING OUTPUT
1	1	Prepare test rope and ship to the German rope laboratory for installation in a test bed
	2	The testing of the rope by various local and international RCA inspectors using different instruments and techniques (2 x German, 1 x Polish, 1 x Canadian, 1 x South African, 1 x USA, 1 x UK)
	3	The submission by each testing team of a comprehensive and very detailed report indicating all anomalies found in the rope by non-destructive methods.



2	1	Return the rope to RSA.
	2	Destructively test a number of samples from the corroded rope to ascertain actual strengths.
	3	A comprehensive report will be submitted regarding the actual condition and strength of various samples cut from the test rope.
3	1	The anomalies reported by the RCA inspectors will be compared in detail to the actual strengths of the rope samples.
	2	Conclusions will be drawn regarding the capabilities of the rope inspectors
4	1	Final report will be submitted containing: <ul style="list-style-type: none"> <li>• An objective assessment of the detection capabilities of the various instruments.</li> <li>• An analysis of the limitations of current instruments and recommendations to RCA inspectors.</li> <li>• Recommendations to instrument suppliers to enhance the detection capabilities of their instruments.</li> <li>• Recommendations to the CSIR who are developing discard criteria for multi-layer ropes regarding RCA instrument capabilities.</li> <li>• Recommendations to SABS to revise and enhance the RCA Code of Practice – SABS 0293:1997.</li> </ul>

**Table 3.8.2 Contractual obligations – GAP535**

The obligations as stated above were met. It must be noted that in addition to the above a literature search was conducted as well as an additional rope NDE organisation was contracted from Canada to participate in the experiment. Additionally the DMT organisation allowed the rope condition assessment inspectors to examine the DMT special test rope with artificial anomalies as well.

## 4 Results

### 4.1 Corroded rope sample

Table 4.1(a) summarises the results of the non-destructive as well as the destructive test results for TP1:

	ACTUAL BREAKING STRENGTH IN kN	ESTIMATED BREAKING STRENGTH IN kN	% LOSS IN BREAKING STRENGTH
Breaking strength of the new rope	961	-	-
Results of destructive test of rope sample	947	-	Approx 1,46%
<b>NDE RESULTS</b>			
NORANDA	-	No significant loss	-
Lloyds Beal Limited	-	No significant loss	-
DMT	-	Nominal of new rope	-
NDT Technologies	-	-	Assume 0%
Universität Stuttgart	-		Approx 0%
AATS	-	No significant loss	
Meraster	-	800 – 940	between approx 2,2% and 16,8%
Rotesco	-		Less than 1%

**Table 4.1(a) Corroded sample: TP1 results**

Table 4.1(b) summarises the results of the non-destructive as well as the destructive test results for TP2.

	ACTUAL BREAKING STRENGTH IN kN	ESTIMATED BREAKING STRENGTH IN kN	% LOSS IN BREAKING STRENGTH
Breaking strength of the new rope	961	-	-
Results of destructive test of rope sample	497	-	48,3%
<b>NDE RESULTS</b>			
NORANDA			10% best case 20% worst case
Lloyds Beal Limited			greater than 14%
DMT			between 20% and 25%
NDT Technologies			approximately 9%
Universität Stuttgart		At least 80% of new	not more than 20%
AATS		approx 576kN	approximately 40%
Meraster		500kN to 690kN	between 28% and 50%
Rotesco			between 30% and 44%

**Table 4.1(b) Corroded sample : TP2 results**

#### 4.1.1 Comments by the rope inspection experts on their results

The following comments were extracted from the various reports submitted by the rope inspection experts contracted.

##### 4.1.1.1 Noranda

Comment 1: test circumstances were quite different from testing at a typical mine site as the ropes remained stationery and the test head moved. Test equipment approached heavy steel structures at both ends of the tested ropes. The steel structures have an effect of increasing the measured metallic area value at the end of travel.

Researchers comment:

- (a) wherever possible a distance of at least 2 m of rope length was available between the rope sections to be tested and the heavy metal structure at the termination of the ropes to negate this problem.
- (b) Instruments should be sufficiently shielded from external influences as instruments are moved along stationery ropes passing metal objects when testing sinking winder stage ropes and stay ropes. In shafts other conveyances and ropes pass by the rope test instruments during the testing process.

Comment 2: Our second comment relates to the short lengths tested. The Manograph II and the PermaScan are both designed to derive Damage Index from the measured LF and LMA traces. This process requires the full frequency spectrum of the primary signals. For these reasons the AC coupled LF traces have a very low frequency cut-off. When testing short lengths of wire rope, this AC coupling results in a slowly ascending LF trace. In normal mine site testing, this is hardly noticeable. In the tests done at DMT, because of the short lengths, the AC coupling effect is very visible and had to be eliminated for the final results. (A simple processing step).

Comment 3: There were no broken wire signals visible on the 36 mm rope sample traces.

The TP2 portion shows severe high-frequency local fault signal variations, related to internal corrosions.

#### Interpretation

While the Local Faults and Metallic Area traces contain all the information available from the NDT test, the analysis of the test data requires interpretation, and is rarely free of some level of subjectivity (especially when trying to estimate the remaining strength of the rope). In order to decrease the subjectivity involved in the analysis of the data, we developed a wire rope "Damage Index" which, based on known physical characteristics of wire rope degradation mechanisms, uses the LF and MA signals to provide a "GO/NO GO" type of indication to the operator. The Damage Index still requires calibration for the type of wire ropes tested in Bochum. However, we present the Damage Index graphs for both samples and describe how, in our opinion, it can be used to improve the reliability of the NDT process. Independently from the Damage Index computation, an estimation of the remaining strength of the 36 mm 21 strands sample is also provided, even though we consider this practice to be inherently unreliable.

The estimation of the remaining breaking strength of a wire rope based on NDT results has been shown by a major CANMET study to be an unreliable process. Moreover, recent work done in the United States indicates that, even if available, the knowledge of remaining breaking strength would not be an acceptable criteria for wire rope retirement. This is explained by the fact that, because of the complexity of the degradation mechanism taking place (including work hardening), the strength of the wire rope tend to decrease very fast over the last small fraction of the rope life, long after the first signs of damage appeared. For these reasons, the Noranda/CANMET team strongly disapproves of providing LBS estimates in general, and quite especially in cases like the present, where the team possesses information on only one single test rope sample, without historical NDT results obtained on the 36 mm rope in question.

In view of the foregoing we can only assume that the 'no-defect' section "TP1" has not lost any significant amount of its 'as manufactured' strength, even though its history suggests otherwise (the rope was manufactured in early 1977, installed August 31, 1984, and discarded mid 1997).

As for section "TP2", we again can only provide a range of %LBS, namely from 10% (best case) to 20% (worst case) within which we expect to locate the true %LBS. In other words, per the SA legislation that applies to AAC this rope has to be discarded. The given range is based on our past experience; on the maximum %LBA found in the corroded section; on the assumption that the 'best' rope section is still at, or near to, the 5.978 Kg/m quality mark; and on the fact that the wires of primary interest in this rope range from 1.52 mm to 2.2 mm, with consequently the likelihood of only a relatively modest work-hardening process.

An inspection of the Damage Index trace of the sample shows a drastic variation from approximately  $0.15 Vm^{1/2}$  for section "TP1" to over  $2 Vm^{1/2}$  in section "TP2", ie an increase by a factor of nearly 20. Based on our fatigue testing results, this would indicate that this section, if used under any significant loading, could fail unpredictably at any time, and confirms the need to retire it from service.

#### **4.1.1.2 Lloyds Beal**

The extend of the corrosion saturated the outputs of the test equipment, but was estimated to be in excess of 7% loss in metallic cross section area (CSA).

The outputs from the test equipment had saturated in two ways during the tests of this rope. Firstly, the metallic cross sectional area (CSA) output saturated at a loss of approximately 7%. This was caused because the equipment has been set for testing locked coil ropes which typically do not lose as large a CSA as in this case. Investigations have since shown that minor adjustment would cater for larger CSA output changes. Secondly, the local fault (LF) output saturated at higher test speeds. This was caused by the recording equipment and should be curable by simple adjustment. Normally, testing is carried out at a test speed of 1 m/s.

The magnetic NDT results suggested the presence of heavy corrosion in the rope. The results would have effectively masked the signals from any broken wires.

Prediction of loss of tensile strength in ropes is notoriously difficult, and becomes more so with increasing rope complexity of construction. However, it has been found with other types of steel wire rope that, in the case of corrosion, a doubling of the loss in CSA (in %) can give an approximation. Therefore, assuming no significant tensile strength loss in the 'good' section of the rope, the CSA loss of greater than 7% should give an estimated loss in tensile strength exceeding 14%.

#### **4.1.1.3 DMT**

The magneto inductive test showed a loss of metallic cross section area of max 15% within the most corroded area. The LF-trace detected an increasing of the noise signal due to corrosion. In this area there are also detections recognisable which correspond loss of metallic cross section area due to wire breakers and also an increasing of metallic cross section area. The reason for these detections is due to the complete damage of the 4th layer of strands (6 x 3 x 1,52 mm) by corrosion and abrasion. The metallic cross section of these 6 strands amounts to 4,6% of the total cross section area of the rope. The remaining particles of these damaged strands effect an intensified corrosion as well as abrasion within this rope section and also a local increasing of metallic cross section area caused by accumulation of metallic particles. This corrosion and also abrasion contribute to the additional loss of metallic cross section area of about 10 – 11%.

This kind of selective corrosion is combined with notches on the wire surfaces. The experiences of DMT-TesTec have shown that this kind of damages effects loss of breaking strength of about 5 to 10% in addition to the loss of cross section area.

The remaining breaking strength of this rope was determined 20 to 25% lower than the nominal breaking strength.

The remaining breaking strength of the rope section without corrosion should correspond to the nominal breaking strength because the tests, neither magneto inductive nor visual, show corrosion or abrasion in significant range.

#### **4.1.1.4 NDT Technologies**

NDT Technologies, Inc. performed the tests as follows:

Phase 1: An LMA-250 tester of the proprietary LMA-Test design by NDT Technologies, Inc was used. This instrumentation, if used in combination with NDT Technologies' NDT\_CARE™ (Computer Aided Rope Evaluation) Software, allows a *Quantitative Resolution or Averaging*

*Length* of 50 mm. This means, the *Signal Enhancement Algorithm* that is part of the NDT\_CARE™ software include the following useful features.

- The Signal Enhancement algorithm greatly improves the *Quantitative Resolution* or *Inspection Accuracy* of EM rope inspections.
- The software makes test results completely independent of rope speed, and it allows scaling and customised formatting of charts.
- Test results can be displayed in the forward or reverse direction. This is useful for comparing results from subsequent inspections that were performed with the rope running in opposite directions.
- An overview chart of the entire rope length on a single page allows easy location of critical rope sections for a more careful evaluation.
- The program allows the convenient calibration of test results by using the proven and very simple “calibration wire” method.
- The program’s Post-Calibration feature offers an alternative approach to calibration. The Post-Calibration procedure is graphical and is performed by clicking-and-dragging on one of the charts.
- The software allows zero adjustment of the LMA trace. This is important when the inspection is started on a deteriorated section of the rope. The adjustment procedure is completely graphic and consists, essentially, of a click-and-drag operation on any one of the charts.
- The software allows the repair of defective data that can be caused by resetting the LMA and LF traces during an inspection.
- Correct distance labelling with respect to a reference marker on the rope is possible. This can be done in the forward or reverse direction.

Phase 2. For the Phase 2 experiments an *annular coil* arrangement in combination with an electronic integrator circuit was used for LMA measurements. The LF signal is derived directly from the annular coil, without integration. (Note that this method makes the LF signal speed sensitive).

The *annular coil* approach is well-known and used by several manufacturers of EM wire rope testers. In theory this method has some significant advantages as follows:

- (i) It allows inspections with exceptional accuracy and resolution.
- (ii) Test results are not influenced by foreign steel objects that move relative to the sensor head.

However in spite of these advantages, the annual coil method poses two very difficult problems.

- (i) An annular coil must be wound on the rope for each inspection, a very inconvenient procedure for in-situ inspections.
- (ii) Because only coils with very few turns can be wound onto the rope, the signal-to-noise ratio of the coil voltage is low. This causes the integrator to drift, which, in turn, makes inspections of long ropes – that require more than a few minutes for their inspection – very inaccurate, if not impossible.

The present inspections concern short ropes in a laboratory setting. Therefore, in spite of its serious drawbacks and because of the abovementioned advantages, the annular coil approach was chosen for the Phase 2 experiments.

### **Loss of Breaking Strength (LBS) Estimates**

Concerning LBS estimates, NDT Technologies, Inc holds the following opinions:

1. It is impossible to measure LBS by non-destructive means, and
2. even if LBS measurements were possible, they would be useless because LBS is a very poor indicator of the actual rope condition. Therefore, LBS should not be used for making rope retirement decisions.

These opinions are based on the following observation:

As a rope deteriorates, two processes take place simultaneously:

1. It loses metallic cross-sectional areas, which **decreases** breaking strength.
2. At the same time, lubricant deterioration, interstrand nicking and corrosion pitting prevent the wires in a rope from moving freely against each other. Paradoxically, this effect **increases** rope efficiency and, therefore, breaking strength.

As the rope deteriorates, these processes will approximately cancel each other. The net effect is that most ropes lose little breaking strength – and, paradoxically, can even gain breaking strength – over their entire useful service life. They lose breaking strength only toward the end of their lives, when they will rapidly deteriorate. The referenced paper contains further details on these phenomena.

NDT Technologies, Inc holds the opinion that either LMA and/or *Aggregate Strength* are better indicators of the condition of a rope.

Since the contract requires breaking strength estimates, educated guessing will be used to make these estimates.

#### Airgap

The sensor arrangement of the LMA-250 Rope Tester has a diameter of 85 mm. For Rope 2, this translates into an *airgap* between the surface of the rope and the test head (also called *liftoff* in the following) of approximately 25 mm.

Note that, unfortunately, during the tests of Rope 2, the electronics used for the Annular Coil method saturated. This problem was not detected in time. Hence, no data for these tests are available.

As for Rope 1, sensor (coils) with a liftoff and a width that are as small as possible would significantly improve the accuracy (or resolution) of test results. Therefore, in hindsight, the LMA-175 Rope Tester should have been used for the present inspections. This would have allowed an airgap of 14 mm.

#### Loss-of-breaking-strength (LBS) estimates

As explained earlier, we consider it impossible to derive LBS estimates from non-destructive inspections. Further, we consider LBS an unreliable indicator of a rope's condition that should not be used for making rope retirement decisions. Therefore, the following estimate is, at the most, only an educated guess.

The charts show a maximum LMA of 18,5% at a distance of 16.7 m. Therefore, assuming that the rope shows zero LBS over the length TP1 we guess that the rope might have lost 9% of breaking strength over the length TP2. This LBS guesstimate was chosen to be ½ of the measured LMA.

#### 4.1.1.5 University of Stuttgart

The used test-head is “Stuttgart III/60” (electromagnet, power supply 2 Volt 300 Ampere DC) with a single testcoil. Airgap is 7 mm and different speeds according to checklist.

The handed out traces are similar to “48 mm-rope”. The marker and the corroded section is clearly visible in each trace, no influence of testhead-speed or “driving direction”.

The testhead “Stuttgart III/60” can be equipped with two different types of testcoils:

- broken wire sensitive
- corrosion sensitive.

At the Bochum tests the corrosion sensitive searchcoil was used. According to our experience, the arise of the corrosion problem on the 36 mm rope could have been recognised during periodically inspection with our testhead “Stuttgart III/60”. Corrosion gives an extended “noise—to-signal” on the trace.

We are estimating the remaining strength of the rope according to our experience (published eg in the scientific work of Reiger 1983: “Ein Beitrag zur magnetinduktiven Querschnittsmessung von Drahtseilen”, page 166 ff ..

The remaining strength of TP1 is around 100% and for TP2 it is at least 80%. The rope should be discarded anyway, because the signal on the trace of the corroded part of the rope is too high. Therefore signals of broken wires can be hidden. As a consequence, a reliable prediction of rope condition is not possible.

The corroded rope was also tested using the “Hochauflösende magnetische seilprüfmetode” which uses 32 radially mounted and 32 axially mounted Hall effect devices to assess the magnetic disturbances caused by the rope. The instrument is capable of presenting the magnetic fields around the rope surface in 3D. The result of the analysis using the instrument is the same as for the other instrument.

#### 4.1.1.6 AATS

The indicated steel area loss on both the AATS and RMS instruments were the same.

##### TP1 – 3.75 m

As no defect was detected in this area it is most likely that there will be very little change in breaking strength.

##### TP2 – 3.75 m

The instrument was calibrated with 3 x 3 mm wires for a pen deflection of 6 mm. The trace sensitivity will then be 2 mm = 1% and with this in mind the indicated steel area loss was 44 mm ÷ 2 = 22% indicated reduction in steel area.

According to the general conversion curve that AATS uses for converting reduction in steel area to loss in breaking strength the breaking strength, will be down by approximately 40% and therefore will break at approximately 576 kN.

#### 4.1.1.7 Meraster

##### Remaining breaking strength of the rope section TP1

Signal traces obtained during the test indicate no broken wires in outer and medium layer of the section TP1. Comparison of INNER and OUTER signals indicates that there are signals generated mainly by rope core defects.

Remaining breaking strength of the section has been calculated on the base of INT signal trace.

INTEGRAL channel indicates total of the INNER signal calculated by integration of INNER signal on the running length set as Integral range (40 x diameter of the rope).

Signal value: INT readout (mm) x INT x INNER sensitivity (mV/mm)  
6.5 mm x 1 x 2 mV/mm = 13 mV  
Calibration value: 0.769 mm<sup>2</sup>/mV for sensor with reduction insert and breakage slot of 1 mm  
Rope cross-section area reduction: 13 mV x 0.769 mm<sup>2</sup>/mV = 10 mm<sup>2</sup>  
Rope area without core: 596 mm<sup>2</sup>  
Percentage rope cross-section area reduction: 10/596 x 100% = 1.67% ~ 2%

**Remaining breaking strength: 98% x 961 kN = 941 kN**

Since the long operation period of the rope and probability of internal wear expected breaking force should be within range **800-940 kN**.

##### Remaining breaking strength of the section calculated on the base of INT signal trace

INTEGRAL channel indicates total of the INNER signal calculated by integration of INNER signal on the running length set as Integral range (40 x diameter of the rope).

Signal value: INT readout (mm) x INT x INNER sensitivity (mV/mm)  
7 mm x 1 x 50 mV/mm = 350 mV  
Calibration value: 0.769 mm<sup>2</sup>/mV for sensor with reduction insert and breakage slot of 1 mm

**Rope cross-section area reduction: 350 mV x 0.769 mm<sup>2</sup>/mV = 270 mm<sup>2</sup>**

Rope area without core: 596 mm<sup>2</sup>  
Percentage rope cross-section area reduction: 270/596 x 100% = 45%

**Remaining breaking strength: 55% x 961 kN = 528 kN**

Since the indicated damages of rope core breaking force may be greater than calculated. Expect breaking strength: within range **500-690 kN**

##### Rope cross-sectional reduction calculated on the base of HALL (LMA) signal

Signal value: HALL readout (mm) x HALL sensitivity (mV/mm)  
6.5 mm x 20 mV/mm = 130 mV  
Calibration value: 1.0 mm<sup>2</sup>/mV for sensor with reduction insert and breakage slot of 5 mm

**Rope cross-sectional area reduction: 30 mV x 1.0 mm<sup>2</sup>/mV = 130 mm<sup>2</sup>**



**4.1.1.8 Rotesco**

The rope was non-destructively tested using a standard Rotescograph test head with a minimum airgap of 5 mm between the rope and the test head and at a test speed of approximately 0.5 M/min.

Before proceeding with the test runs, the calibration of the LMA channel was established by inserting a steel wire rod of diameter 3.175 mm (1/8”) into the test head alongside the rope. The rod, with a metallic area of 7.917 mm<sup>2</sup>, would represent a metallic area increase relative to the ropes 707.83 mm of 1.1%. The gain of the LMA channel chart was adjusted so that this is represented on the chart as 1.1 divisions (each division represents 1% LMA).

The chart from this test shows LF and LMA patterns which indicate:

- (a) over approximately 12.5 meters (the section which includes TP1) the presence of no significant deterioration, since the LMA trace is essentially a straight line (with only minor variations) and the LF trace is small and consistent in amplitude over this length.
- (b) over approximately 3.7 meters (the section which includes TP2) the presence of significant corrosion (erratic large amplitude deflections in the LF and LMA traces).

The LBS estimate for the test piece TP1 would be less than 1% (no calculations are involved), since the minor deviations in the LMA signal are less than 0.5%. We suspect that the actual breaking strength relative to the original breaking strength may have changed (increased or decreased) due to metallurgical changes in the rope steel, but this is beyond our capabilities to measure.

With reference to the LBS Estimation Formulas-Case 1 at the end of this Report, the LBS estimate for the test piece TP2 (relative to that of TP1) would be as follows:

- The maximum LMA within TP2 is 9,7% relative to LMA level of TP1. **LMA<sub>max</sub> = 9.7%**
- The average peak to peak amplitude of the LF signal at the point of maximum LMA is approximately 5 divisions. **LF<sub>max</sub> = 5**
- The average peak to peak amplitude of the LF signal within TP1 is approximately 1/3 of a division **LF<sub>lay-noise</sub> = 1/3**
- The multiply factor  $K = \sqrt{\frac{LF_{max}}{LF_{lay-noise}}} = 3.8$  **factor K = 3.8**
- The LBS estimate for TP2 is **K x LMA<sub>max</sub> = 3.8 x 9.7% = 37% LBS** **LBS<sub>est.</sub> = 37%**
- We normally express the uncertainty of an LBS estimate as approximately +/- 20% of the actual value (for example a 5% LBS would be expressed as 5% +/- 1% = 4 to 6% and a 10% LBS would be expressed as 10% ± 2% - 8% to 12%). This is because the uncertainty of an LBS estimate tends to increase as the LBS increases. Therefore, our LBS estimate of the TP2 test piece would be 37 +/- 7 = 30 to 44%.

The rope was also non-destructively tested using a standard Rotescograph test head with a minimum airgap of 5 mm between the rope and the test head and at a test speed of approximately 0.5 M/min. However, in this case, a solenoid coil of diameter 6.4 cm (2.5”) located around the rope in the test head was used to provide a relatively high resolution LMA signal which was recorded (instead of the Rotescograph LF signal) along with the Rotescograph LMA signal. Prior to running the test, a 1.524 mm (0.06 inch) diameter steel wire with length approximately 20 cm (8 inches) was taped to the rope in order to verify the calibration of the solenoid LMA channel gain setting. This wire represents a metallic area increase in the rope of 0.26%. The solenoid coil LMA trace shows a maximum LMA value of 12% within the test piece section TP2.

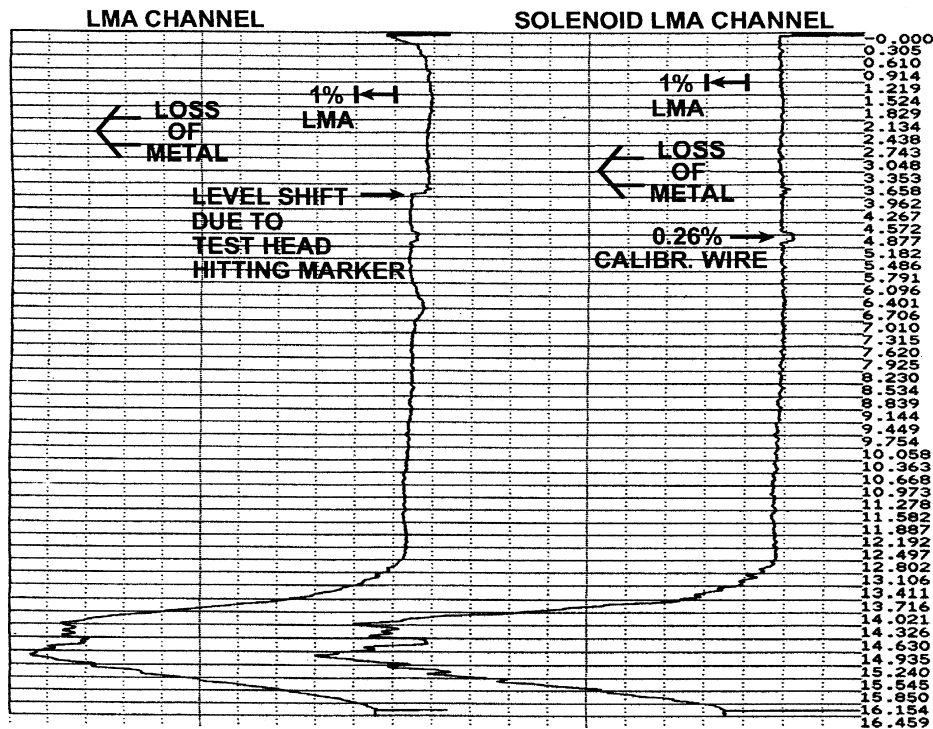

Chart 5

Comments regarding the effectiveness of using breaking strength as a criteria for rope discard

Although the estimation of loss of breaking strength (LBS) is admittedly an imperfect science, there are several reasons why we believe that it should be used as one of the criteria for rope discard as follows:

1. The designers and operators of hoisting installations are most concerned about the breaking strength of a rope, and the concept of LBS is straightforward and familiar to everyone involved.
2. It is important that there is an independent method of substantiating the non-destructive test result to prove whether it is effective in determining when a rope should be removed from service. Destructive break tests are a practical method of checking the effectiveness of LBS estimates. Other rope removal criteria would be more difficult to verify.
3. To establish and prove any other rope removal criteria based on non-destructive testing would probably involve correlating the non-destructive test results with destructive (break) tests. If there was insufficient correlation, the rope removal criteria would not likely be accepted. If a satisfactory correlation was established, then the rope removal criteria could be expressed in terms of loss of breaking strength.

LBS estimation formulas:

CASE 1: STRANDED ROPES WITH NO SIGNIFICANT CROWN WEAR

$LBS_{est} = K \times LMA_{max}$ .

where:  $K = \sqrt{\frac{LF_{max}}{LF_{lay-noise}}}$

$LF_{max}$  = average peak-to-peak amplitude of the LF Channel at the point of  $LMA_{worst}$

$LF_{lay-noise}$  = average peak-to-peak amplitude of the LF Channel at the point of the  $LMA_{best}$

$LF_{max} = LMA_{best} - LMA_{worst}$

### 4.1.2 Trace comparisons of corroded rope sample

As stated above, the researcher required each of the eight rope inspection authorities to supply traces of the rope recorded at different test head velocities and test head directions.

Unfortunately a number of the traces submitted were very small and strip records short, making analysis difficult. A number of contractors used different chart speeds and different sensitivities for these specified tests. This also made the analysis of certain instruments difficult and was not in the spirit of the experiment.

Quantitative analysis of the traces was not possible. A qualitative assessment was conducted by 2 persons. Trends were clearly indicated in the assessment.

Details of the trace analysis are reflected in Appendix 4.

In some instances a left trace was compared to a right trace taken at a different velocity.

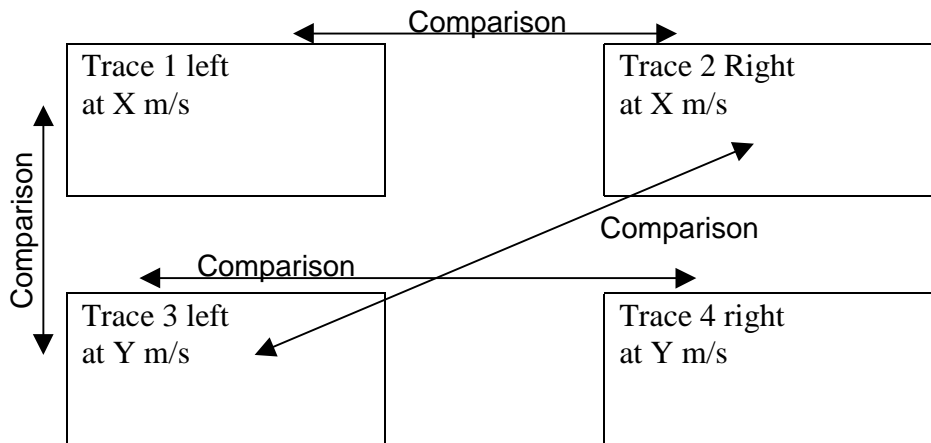

**Figure 4.1.2 Trace comparison**

The detailed analysis of the traces clearly indicated that the velocity of the instrument and direction of instrument travel does affect the output of certain of the instruments used in the experiment. The differences in the traces taken at different velocities/directions will clearly affect the analysis of the rope condition and the accuracy of the rope condition assessment.

## **4.2 Broken wire rope sample**

As stated in section 3.5.2.2 contractors were required to assess the number of broken wires in the rope sections designated DS1 (0,7 m long) and DS2 (8 m long). All the rope testing inspectors submitted results for both sections. There was however an oversight by the contractor who stripped the rope and the actual section DS1 was inadvertently discarded without being analysed. The researcher is therefore unable to compare the results of section DS1 with the actual number of broken wires in this section.

Although the researcher requested that each broken wire identified by the NDE be referenced in axial distance from the marker, this was not attained in all cases. The resolution of a number of the instruments does not allow the inspector to pinpoint each broken wire accurately to the nearest mm or even 100 mm from a fixed point.

Many of the initial reports received by the researcher from the rope inspectors only stated the total number of broken wires in section DS1 and DS2. This clearly did not meet the contractual requirements. The contractors were each requested to supply more detailed information and to reference each broken wire identified to the centre of the marker. A number of contractors reported that this was impossible due to the resolution limits of their instrument and that reports would be submitted detailing the number of broken wires identified in 100 mm or even 200 mm intervals along the axial length of the rope. The researcher had to accept this compromise.

The results from Haggie Rand listing the number of broken wires in each of the inner strands and the results from each rope condition assessment contractor were put into table format for easy analysis. Please refer to Appendix 1 for detail.

A total of 609 broken wires were identified when the 8 meter rope sample, DS2, was destranded into its individual components. Rope condition assessment contractors identified between 0 and 750 broken wires in the same rope sample using non-destructive techniques.

The comparison and analysis of the results in the table format, as reflected in Appendix 1 is difficult and the researcher therefore transformed the data into graphical format. Even though 4 of the contractors reported the broken wires relative to the marker on the rope, the researcher decided to base the graphs on 100 mm and 200 mm axial rope length intervals, for comparison purposes.

### **4.2.1 Details of results: broken wire sample DS2 – 8 m length**

#### **4.2.1.1 Noranda**

##### **4.2.1.1.1 Test 2 results**

The Noranda team identified a total of 31 broken wires along the length of the rope sample using the Magnograph II in terms of the procedures laid down for Test 2. These anomalies were classified on the trace as

- Numerous internal broken wires (small diameter)
- Localised group of broken wires with added MA (possibly some bent back)
- Single broken wire (large diameter).

Each anomaly was referenced to the rope marker ie an exact location for each broken wire was given relative to the marker.

The results of the non-destructive examination are reflected in figure 4.2.1.1.1(a) and 4.2.1.1.1(b) below. The solid line reflects the results of the NDE and the dotted line the actual number of broken wires.

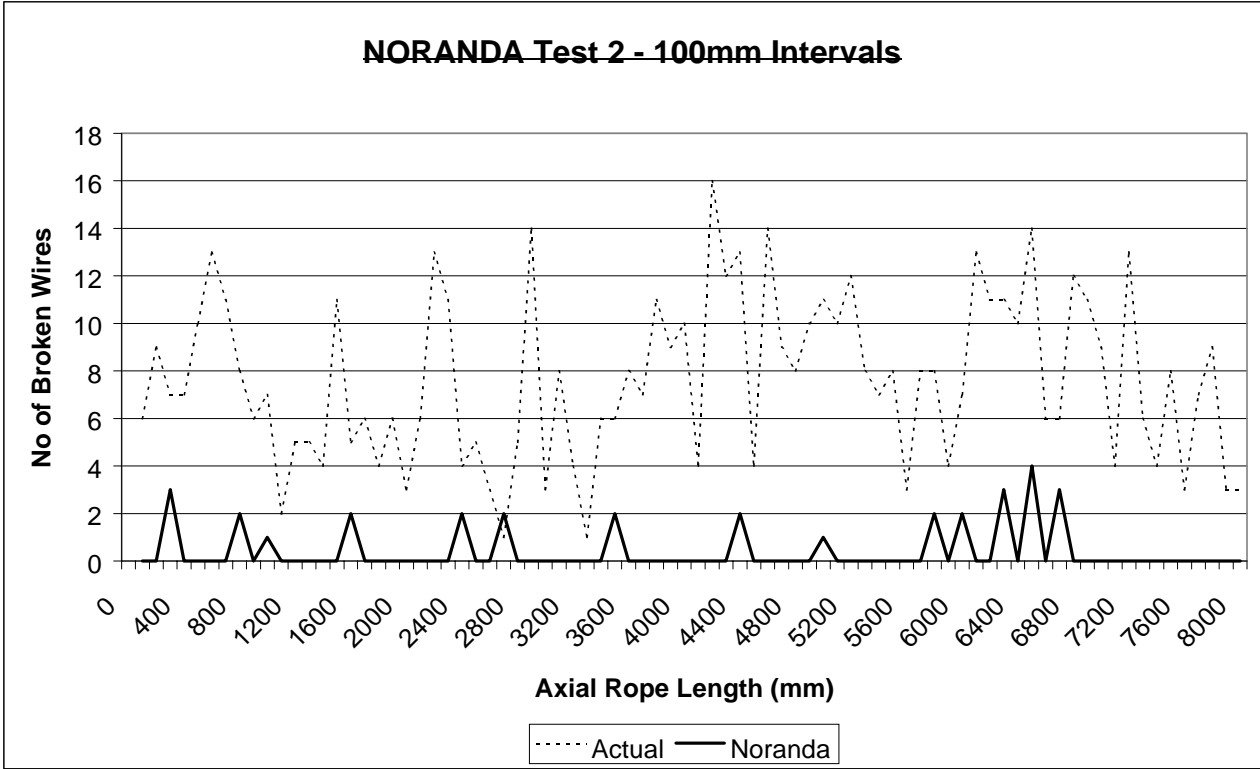

**Figure 4.2.1.1.1(a): Noranda: Broken wire comparison for Test 2 at 100 mm intervals**

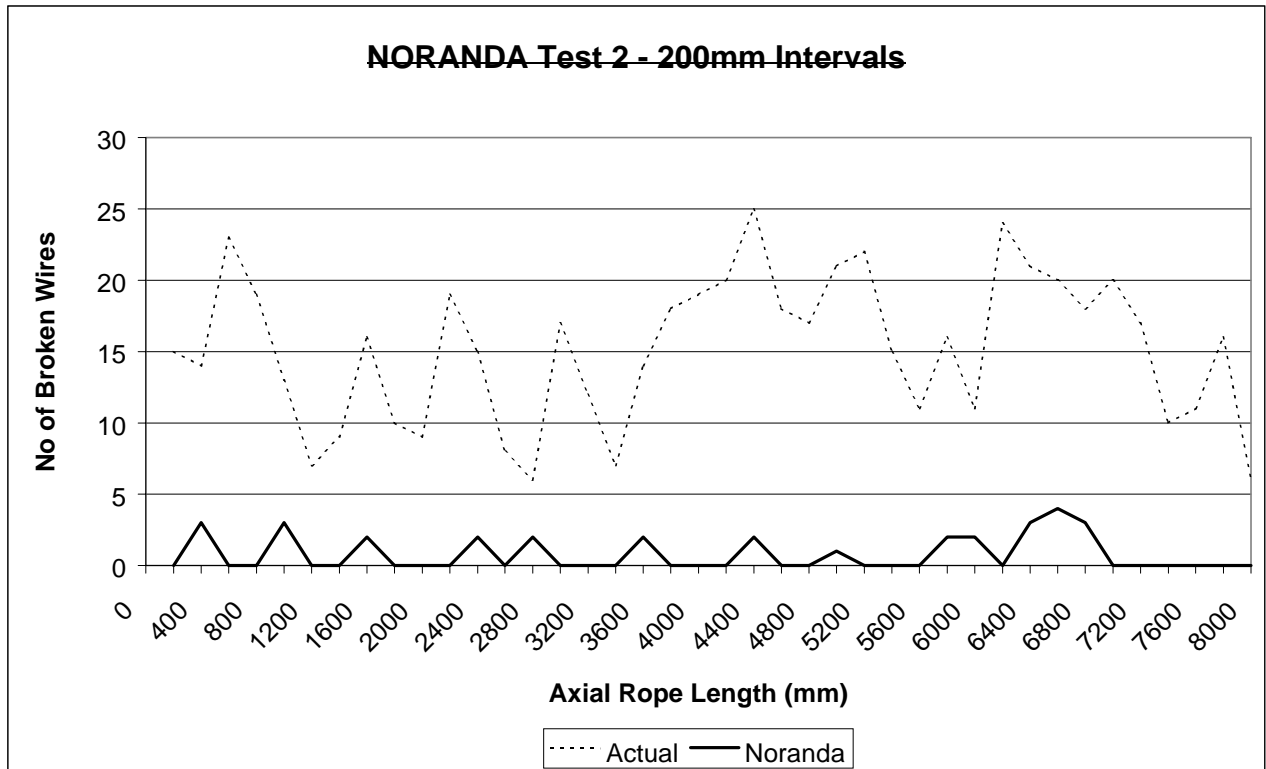

**Figure 4.2.1.1(b) Noranda: Broken wire comparison for Test 2 at 200 mm intervals**

From the graphs it is clear that very few of the broken wires existing in the rope sample were identified; only 5% of the actual number of broken wires were identified by the NDE.

#### 4.2.1.1.2 Test 3 results

Noranda personnel did not report any results of tests conducted in terms of the optional test 3 criteria.

#### 4.2.1.1.3 Comments by Noranda

Most of the comments made by Noranda personnel were reported in section 4.2.1.1.

Noranda further states that the diameter of the broken wires, gap size between wire ends, position of the faults (internal or external) and masking effects resulting from a concentration of faults affect the signal amplitude.

Whether the Local Fault, Metallic Area, or Damage Index is being studied, the best way to evaluate the condition of a wire rope from NDT data is to compare the last test results with the results obtained, in the same conditions, when the wire rope was new, immediately after installation. In effect, some wire rope constructions tend to produce more “background noise” on the NDT instruments signals than others. Departures from this background indicate the development of faults. In the case of the Fishback rope, we compared the results obtained in Bochum with signals recorded on a similar type of rope in a Canadian mine. These recorded traces indicated that for this type of wire rope, the ratio between the amplitude of a single-broken-wire signal to the background noise is approximately four to one. This lead us to conclude that the Local Fault signal activity over most of the length of the sample is due to some type of degradation, most probably internal wire breaks of small diameter (1.16 or 1.52 mm). This “signal activity” is most remarkable in the rope section identified by the letter G in

Figure 1 (section DS2 and part of TP1). In the areas where larger faults are present (eg A and H), these signals, while possibly still present, may be masked by the larger faults.

Figure 5 shows the Damage Index graph of the 48 mm sample. As expected from a rope mechanics point of view, the sections of the sample affected by the most severe damage are the areas showing anomaly on both the LF and LMA traces (such as point A) and the areas in which groups of broken wires are present over a short length (such as point H). Those are the areas that are expected to fail first when submitted to loading. In instrumented fatigue testing with smaller wire ropes, we found that the failure occurred after the Damage Index increased by one order of magnitude. However, the evolution of the damage is not constant over the service life of the rope, the Damage Index remaining unchanged over the first half of the rope life, and doubling by the time three-quarters of the rope life was reached (1). Because damage is present over the whole length of the Fishback sample, it is difficult to estimate the level of damage compared to the rope “as manufactured”. However, we can see that the ratio between the Damage Index of the section showing the worst damage (point A) and the “best” section (point G) is more than two, indicating that the rope already exceeded three-quarters of its service life (if used under constant loading cycles), and probably presents a risk of failure under high-acceleration loading, especially when considering the presence of faults in the “best” section.

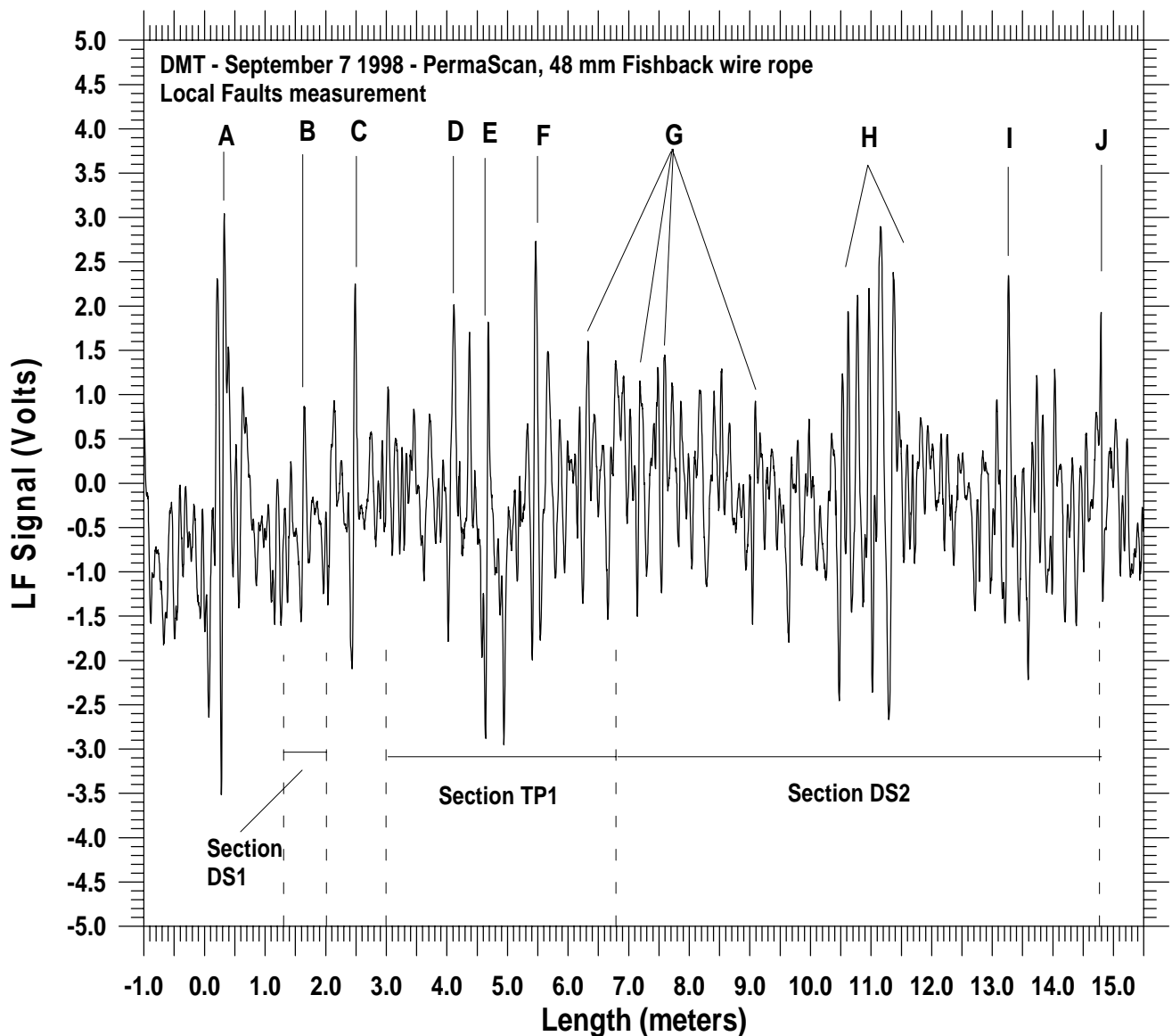

**Figure 4.2.1.1.3(a) Noranda local fault trace for 48 mm fishback**

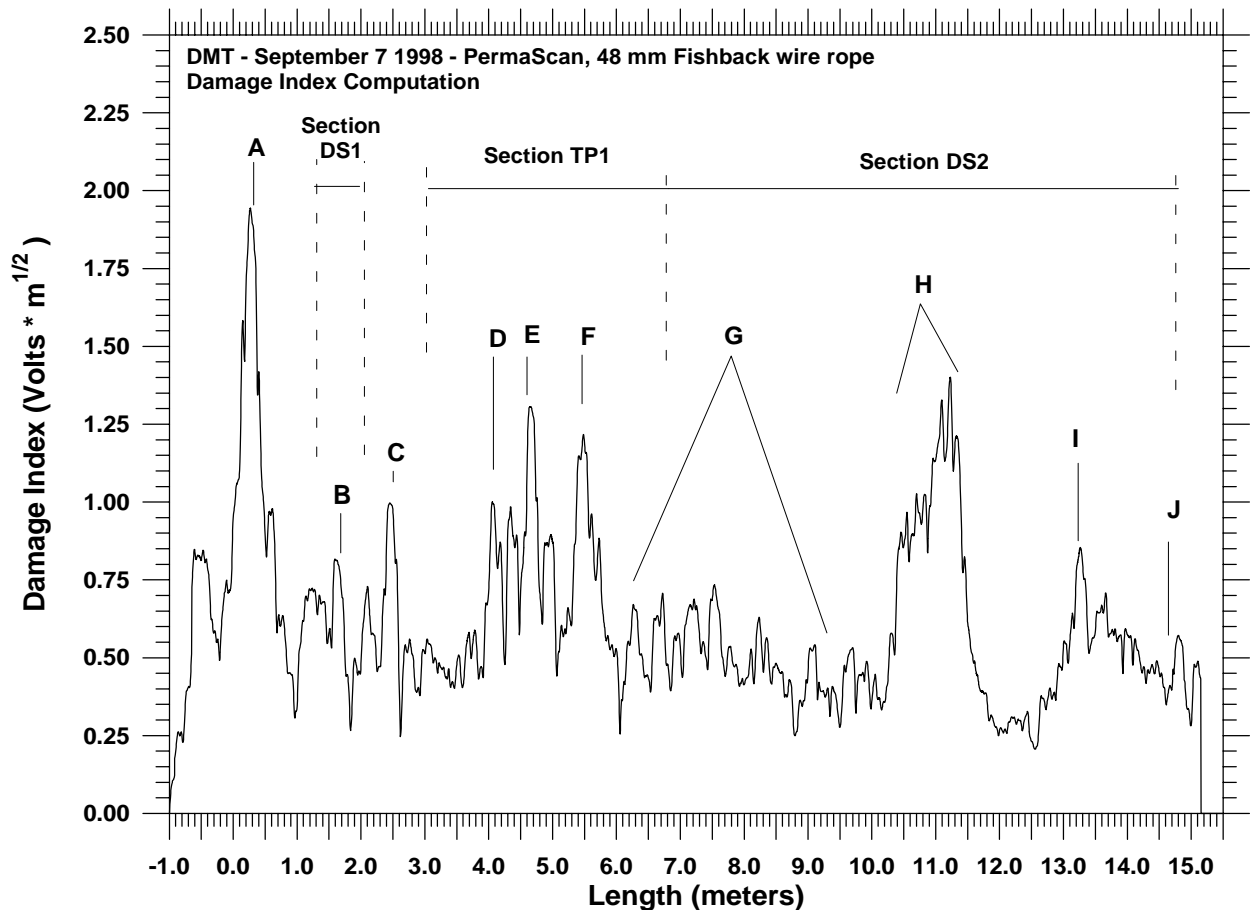

**Figure 4.2.1.1.3(b) Noranda damage index computation over 48 mm fishback**

- Where
- A is a localised group of broken wires
  - B is a single broken wire (small diameter)
  - C is a single broken wire (large diameter)
  - D is a single broken wire (large diameter)
  - E is the wire marker
  - F is a single broken wire (large diameter)
  - G are numerous internal broken wires (small diameter)
  - H are localised groups of broken wires with added MA
  - I is a single broken wire (large diameter)
  - J is the Noranda/CANMET magnetic foil marker

## 4.2.1.2 Lloyds Beal

### 4.2.1.2.1 Test 2 results

Lloyds Beal personnel identified 142 broken wires in the rope sample, which represents 23% of the actual number of broken wires in this sample. The broken wires identified by Lloyds Beal were reported in number of broken wires per 100 mm interval.

The details of the NDE are reported in Appendix 1 and figures 4.2.1.2.1(a) and 4.2.1.2.1(b) below.



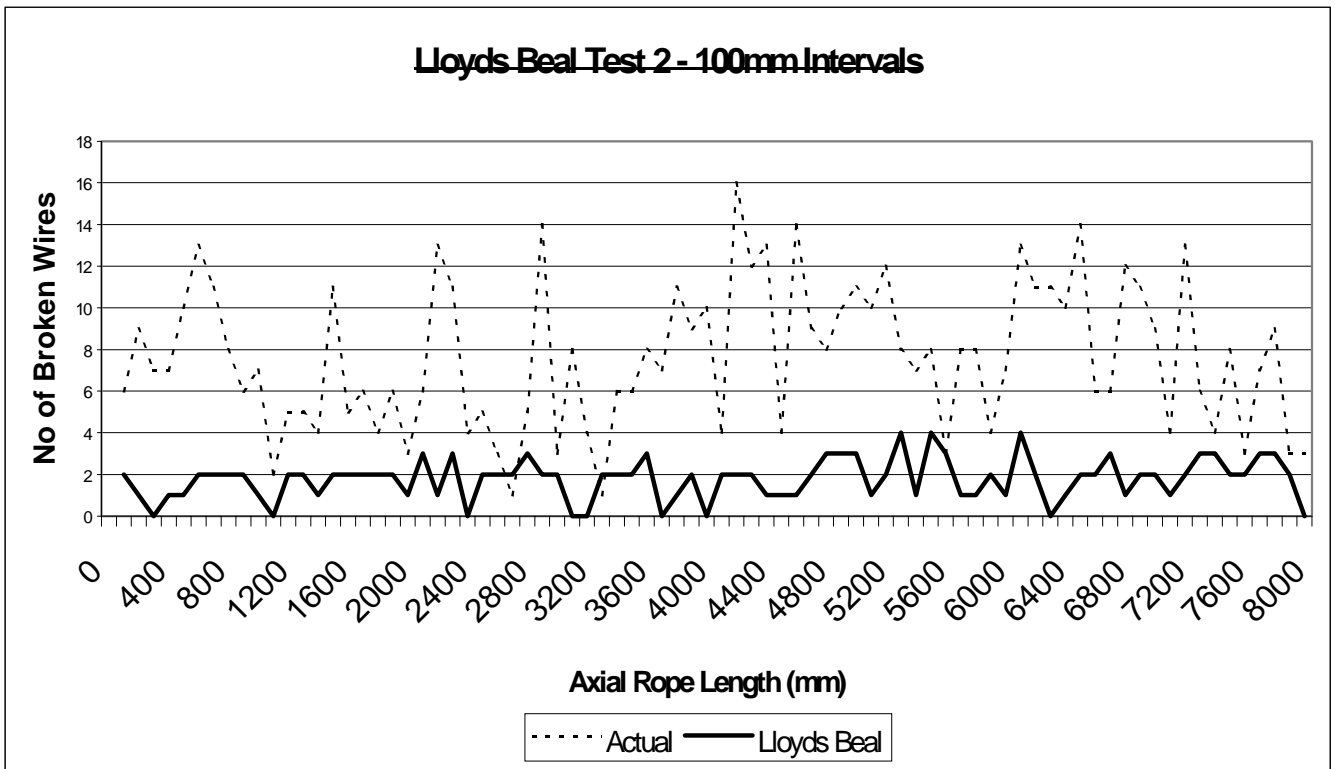

**Figure 4.2.1.2.1(a) Lloyds Beal: Broken wire comparison for Test 2 at 100 mm intervals**

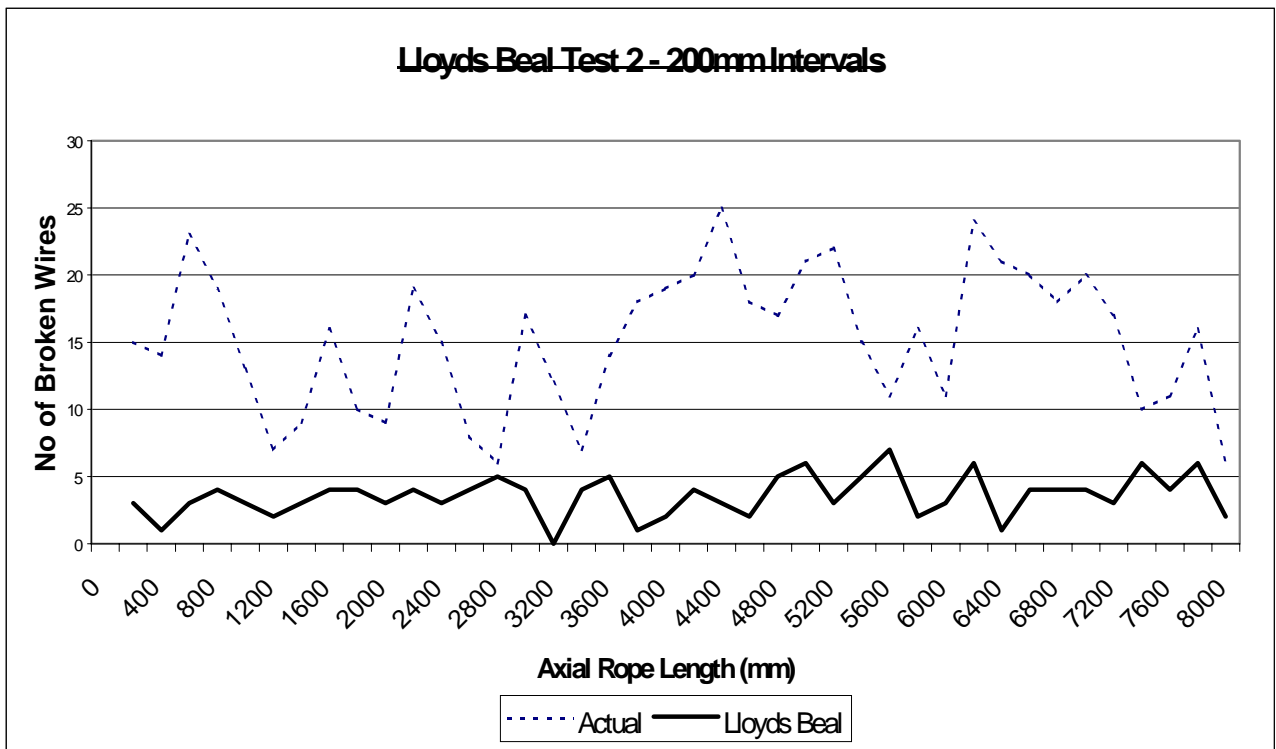

**Figure 4.2.1.2.1(b) Lloyds Beal: Broken wire comparison for Test 2 at 200 mm intervals**

The graphs indicate that the inspectors were able to identify broken wires in areas of the rope sample where broken wires were physically present. However, as stated previously, some 77% of the actual broken wires were not identified. It is also interesting to note that in certain sections, for example at the 2200 mm mark, the inspectors identified 4 broken wires whereas the sample actually contain 19 broken wires in this section.

**4.2.1.2.2 Test 3 results**

In this test Lloyds Beal inspectors used a 48 mm diameter insert in the test head. Results obtained were much better than in the previous test, in that 291 broken wires were identified in the rope sample. This represents 48% of the actual number of broken wires. Such tight inserts are, however, not practicable in the field where grease covers the ropes.

Details are reflected in Appendix 1 and figures 4.2.1.2.2(a) and 4.2.1.2.2(b).

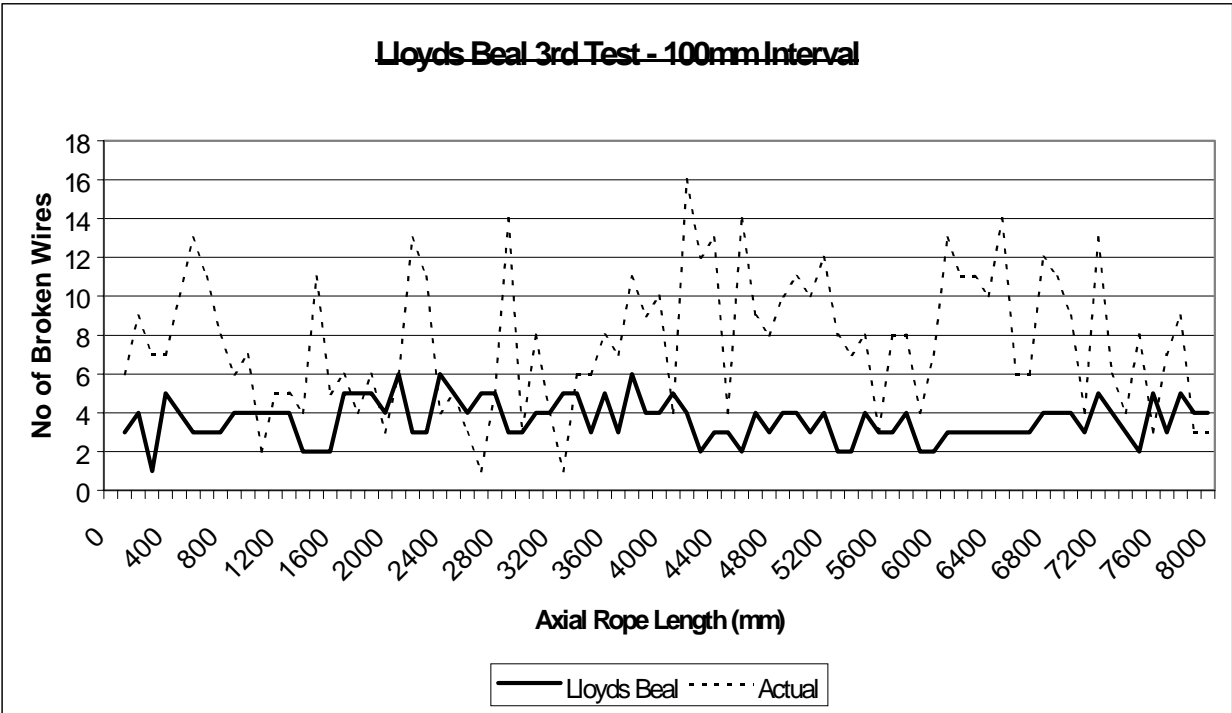

**Figure 4.2.1.2.2(a) Lloyds Beal: Broken wire comparison for Test 3 at 100 mm intervals.**

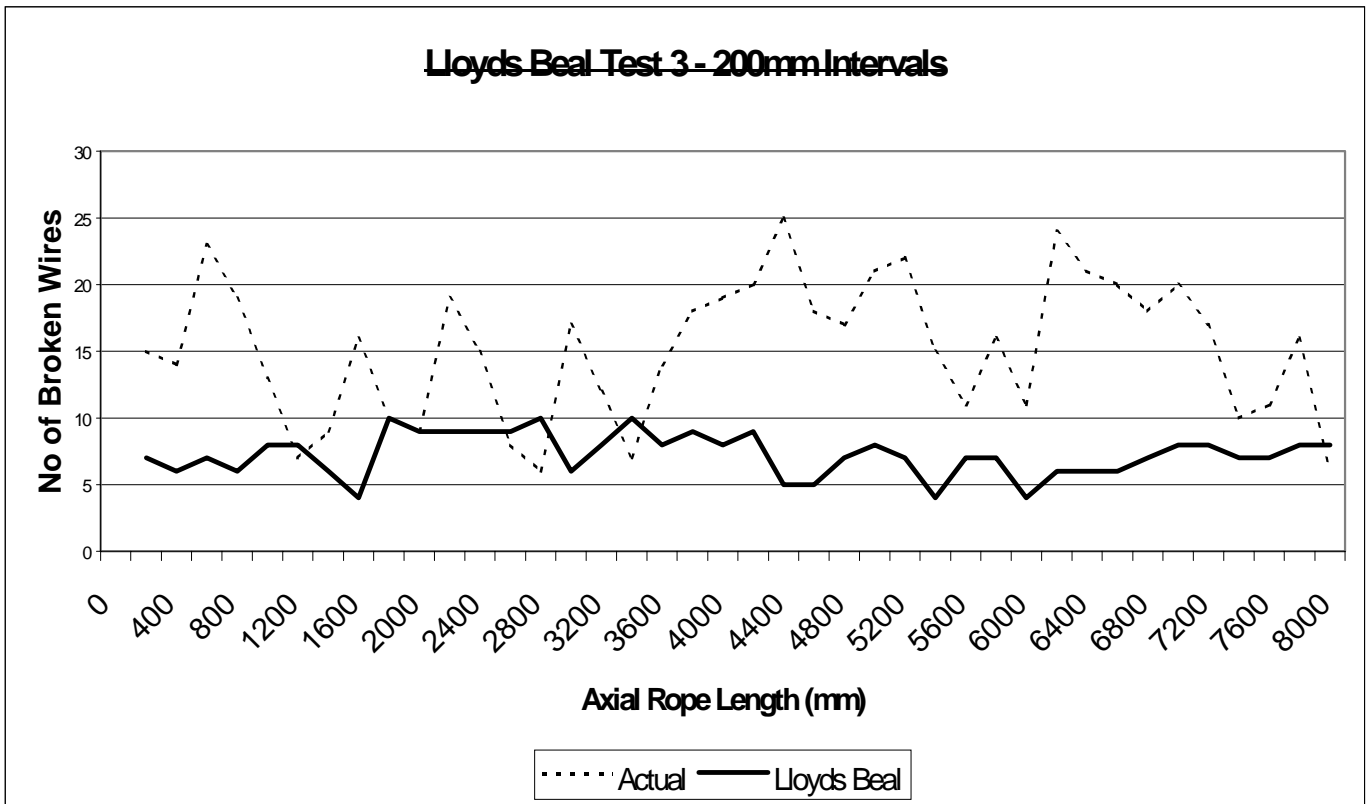

**Figure 4.2.1.2.2(b) Lloyds Beal: Broken wire comparison for Test 3 at 200 mm intervals**

More broken wires were identified and there appears to be a slight correlation between some of the peaks in the graphs. It must be kept in mind that less than 50% of the broken wires were identified in this test.

#### 4.2.1.2.3 Comments by Lloyds Beal

- (i) The sensor guides used to test this rope (60 mm diameter) were actually the largest and therefore least sensitive. Theory dictates that the air gap should be minimal, and this was shown by the improved performance of the 48 mm diameter inserts, although it is accepted that use of such tight clearances is not practical.
- (ii) It was assumed that the rope samples contained internal broken wires. While significant corrosion would be readily identifiable, it has been found that the start of corrosion pitting can be confused with broken wires.
- (iii) It is accepted that not all broken wires will have been detected. However, when the rope sample is stripped for visual examination then it should become apparent what proportion of the broken wires were detected.
- (iv) It is not practical to determine the reduction in tensile strength from these NDT results alone.
- (v) The cross sectional area (CSA) sensor outputs drifted slightly during the tests. This was most likely due to the test head having been pulled along the rope and hence past a lot of steelwork. In practice, the test head would be stationary and the rope would move through it, and moving steelwork (ferrous objects) in the vicinity of the test would be kept to a minimum.

### 4.2.1.3 DMT

#### 4.2.1.3.1 Test 2 results

The team from DMT identified 84 broken wires in the test sample which equates to 14% of the actual number of broken wires in the sample. They initially presented the number of broken wires in 1 meter intervals. This was later refined to 100 mm intervals.

Details of the test results are reflected in Appendix 1 and figures 4.2.1.3.1(a) and 4.2.1.3.1(b) below.

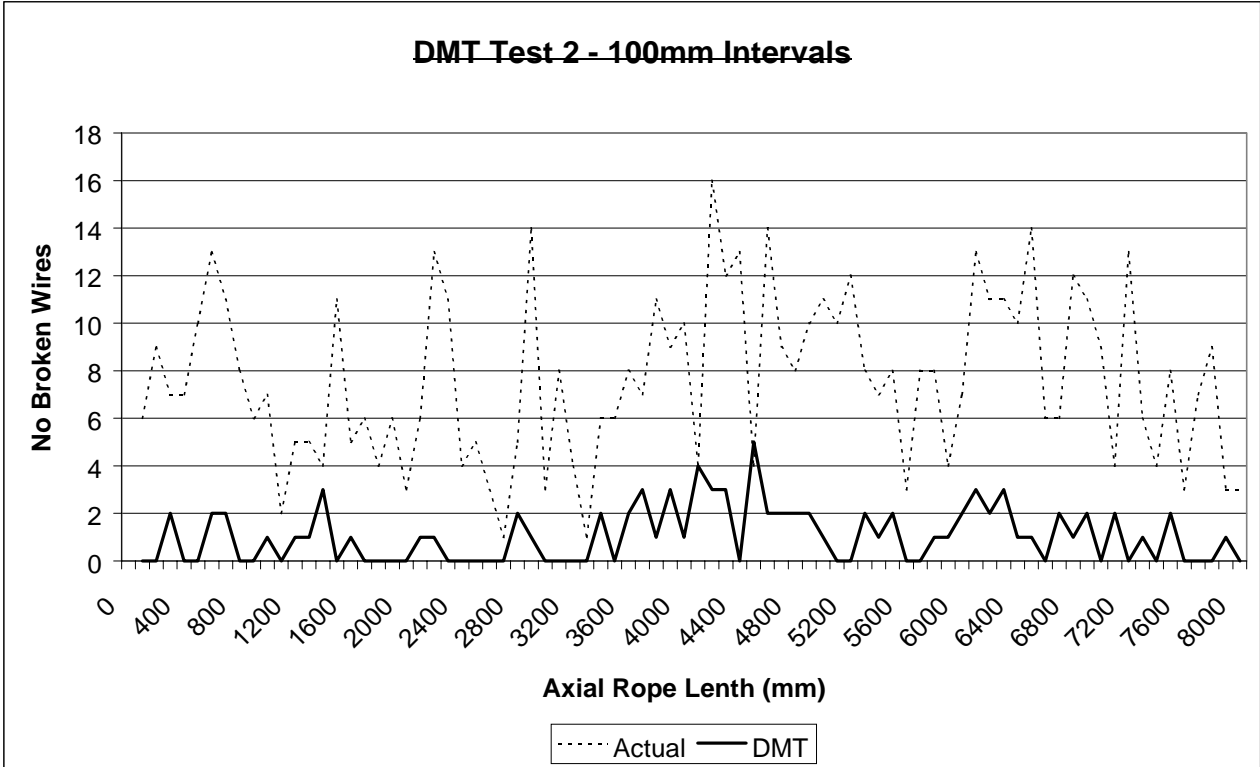
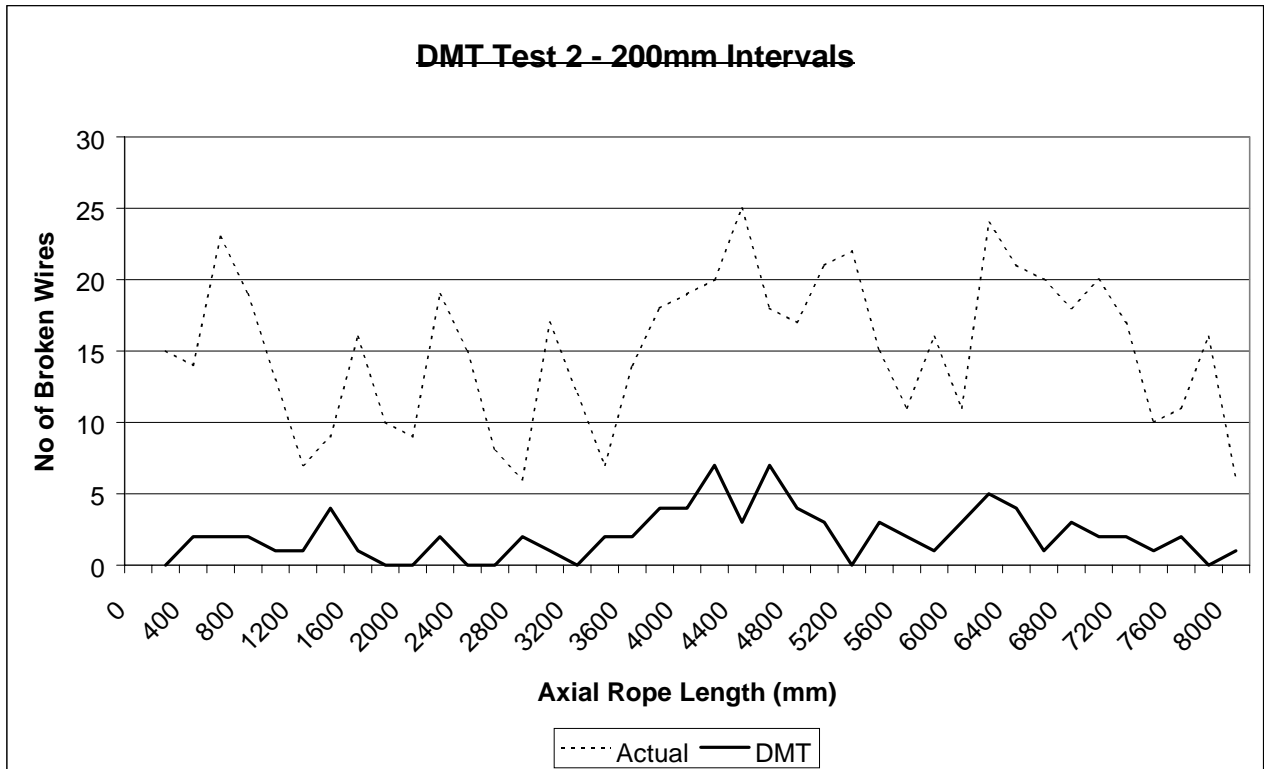

Figure 4.2.1.3.1(a) DMT: Broken wire comparison for Test 2 at 100 mm intervals



**Figure 4.2.1.3.1(b) DMT: Broken wire comparison for Test 2 at 200 mm intervals**

The graphs indicate some correlation between the peaks, although some peaks are slightly offset from one another. This may be due to an axial measurement error in the instrument. It is clearly noticeable that only a small percentage of the broken wires were identified.

**4.2.1.3.2 Test 3 results**

The DMT rope inspectors did not conduct any further examinations in terms of the optional Test 3.

**4.2.1.3.3 Comments by DMT**

There were no comments received from the DMT.

## **4.2.1.4 NDT Technologies**

### **4.2.1.4.1 Test 2 results**

The rope test personnel from NDT Technologies stated in their report that they were able to identify 636 broken wires in the rope sample. This is 27 broken wires more than actually present in the rope sample.

The initial report contained a number of traces and the following comments

“All charts show large clusters of broken wires in areas along the length of the rope at the following distances:

1. 0,3 – 0,7 m
2. 2,5 m
3. 4 m
4. 5,4 m
5. 10 – 11 m
6. 12,4 – 13,5 m

Besides these large clusters of broken wires, the LMA traces show considerable variations of cross-sectional area along the entire length of the rope. This, together with the indications of the LF trace, implies that there are innumerable broken wires and clusters of broken wires along the entire length of the rope”.

At a later date NDT Technologies submitted an addendum to the initial report stating the number of wires identified in terms of 100 mm intervals. The number of wires identified is based on the assumption that a section existed in the rope sample where there were 20 broken wires present in 100 mm of rope. This is more fully explained in section 4.2.1.4.3.

Details of the results are shown in Appendix 1 and figures 4.2.1.4.1(a) and 4.2.1.4.1(b) below.

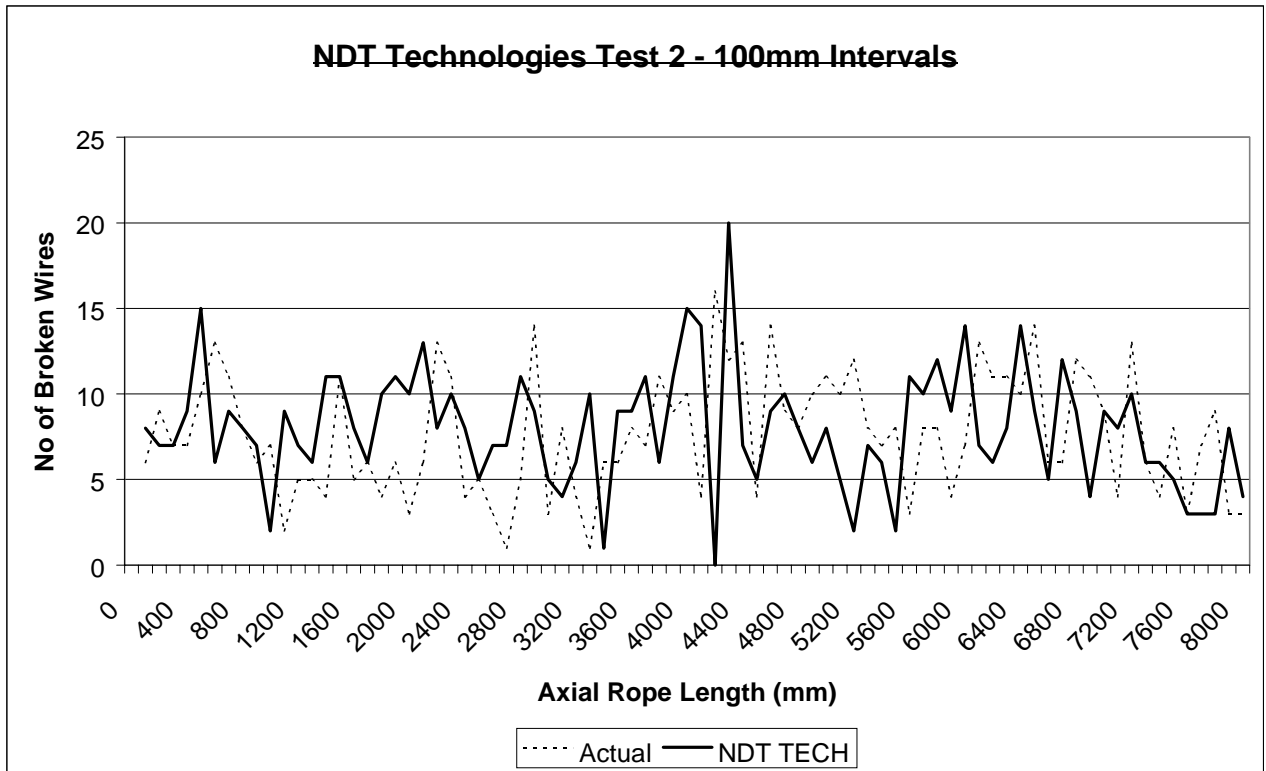

**Figure 4.2.1.4.1(a) NDT Technologies: Broken wire comparison for Test 2 at 100 mm intervals**

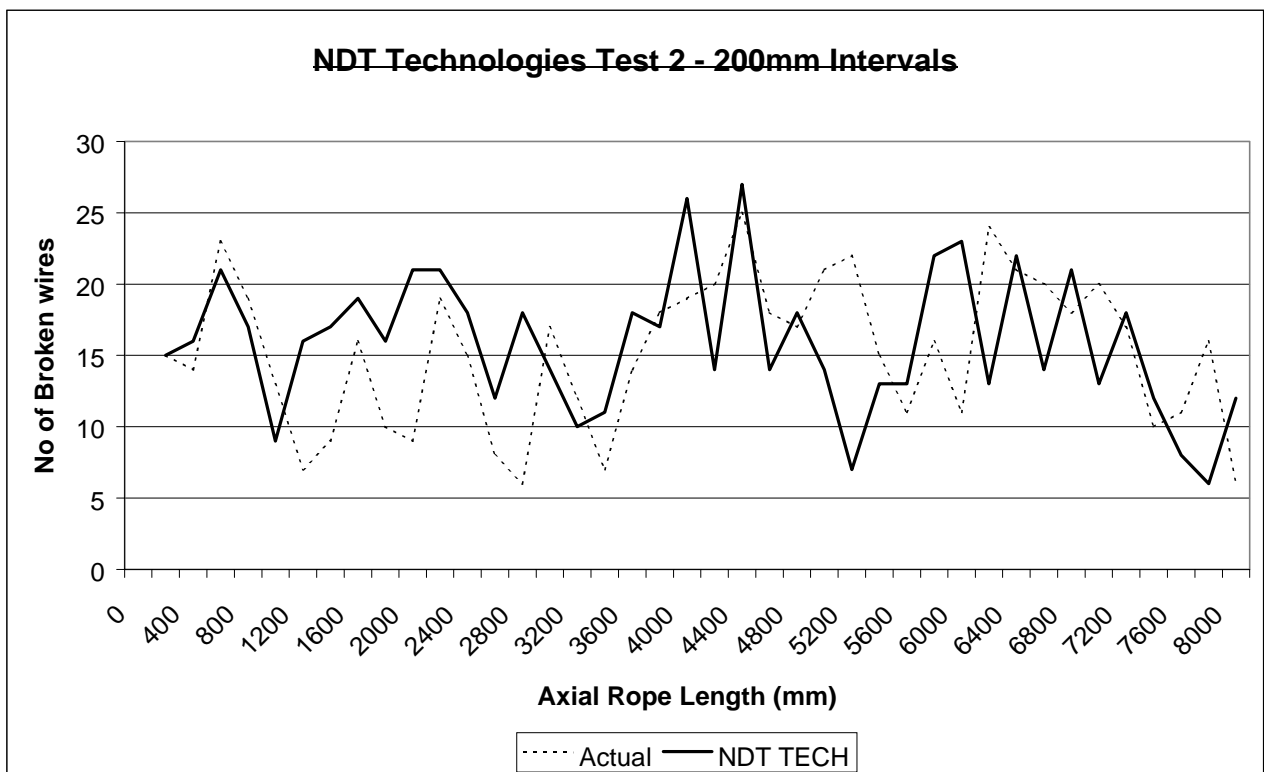

**Figure 4.2.1.4.1(b) NDT Technologies: Broken wire comparison for Test 2 at 200 mm intervals**

The graphs indicate a correlation between the actual number of broken wires and those identified by means of NDT. There is an offset noticeable between some peaks, which may be

due to an axial measurement error in the instrument. The graphs also indicate an overstatement of the number of detected broken wires in the areas closest to the marker and an understatement of broken wires in the 5 200 mm area.

#### 4.2.1.4.2 Test 3 results

In this instance NDT Technologies personnel wound an annular coil onto their instrument to enhance resolution. This methodology is not suited for field testing as a new coil would need to be wound around the rope every time a test is conducted at a mine site.

In this instance the rope inspectors identified 750 broken wires in the 8 meter rope sample. This is 23% more than the actual number of broken wires present in the rope.

The reason for the over estimation of the broken wires can be due to the assumption of  $N_{max} = 20$  broken wire/100 mm being incorrect. In the 8 m section of the rope sample a maximum of 16 broken wires/100 mm were counted at the 4 200 mm mark. However in another section of the rope, between -3860 mm and -3760mm, a total of 24 broken wires were identified when the rope was stripped down.

Details of the results are presented in Appendix 1 and figures 4.2.1.4.2(a) and 4.2.1.4.2(b) below.

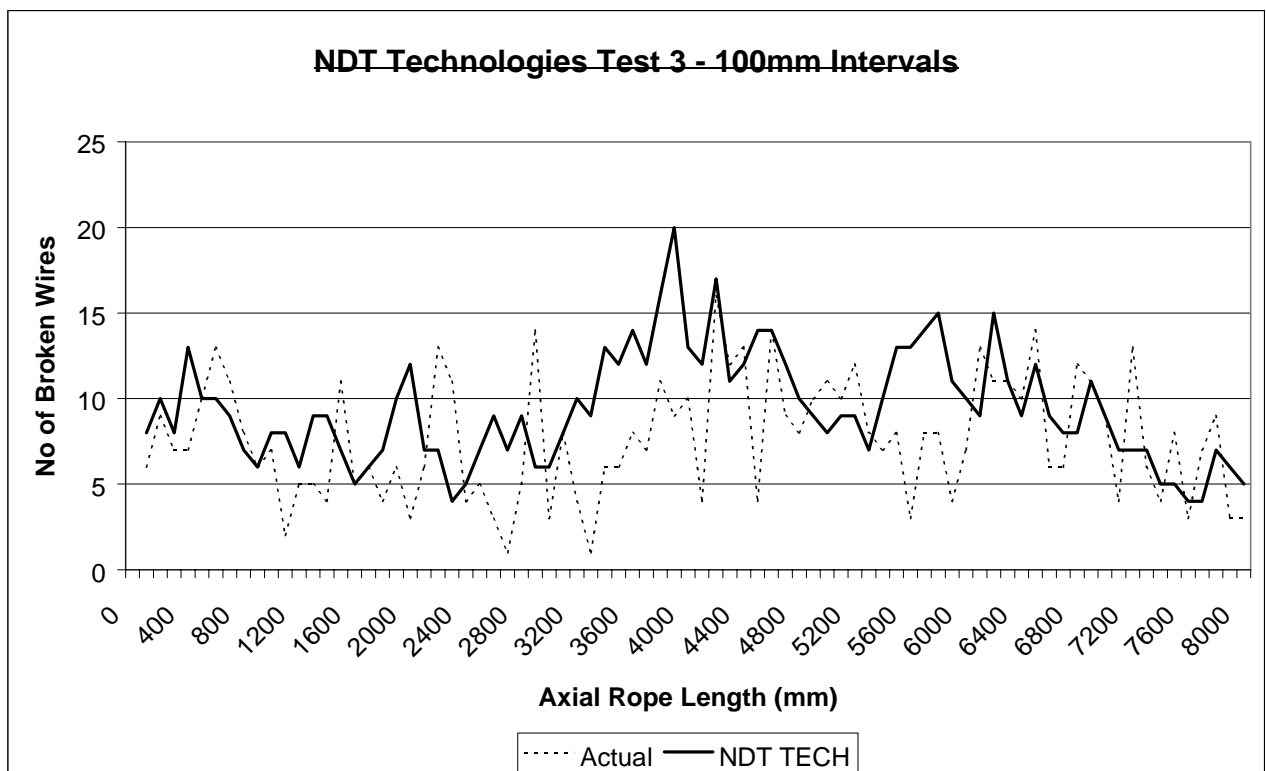

**Figure 4.2.1.4.2.(a) NDT Technologies: Broken wire comparison for Test 3 at 100 mm intervals.**



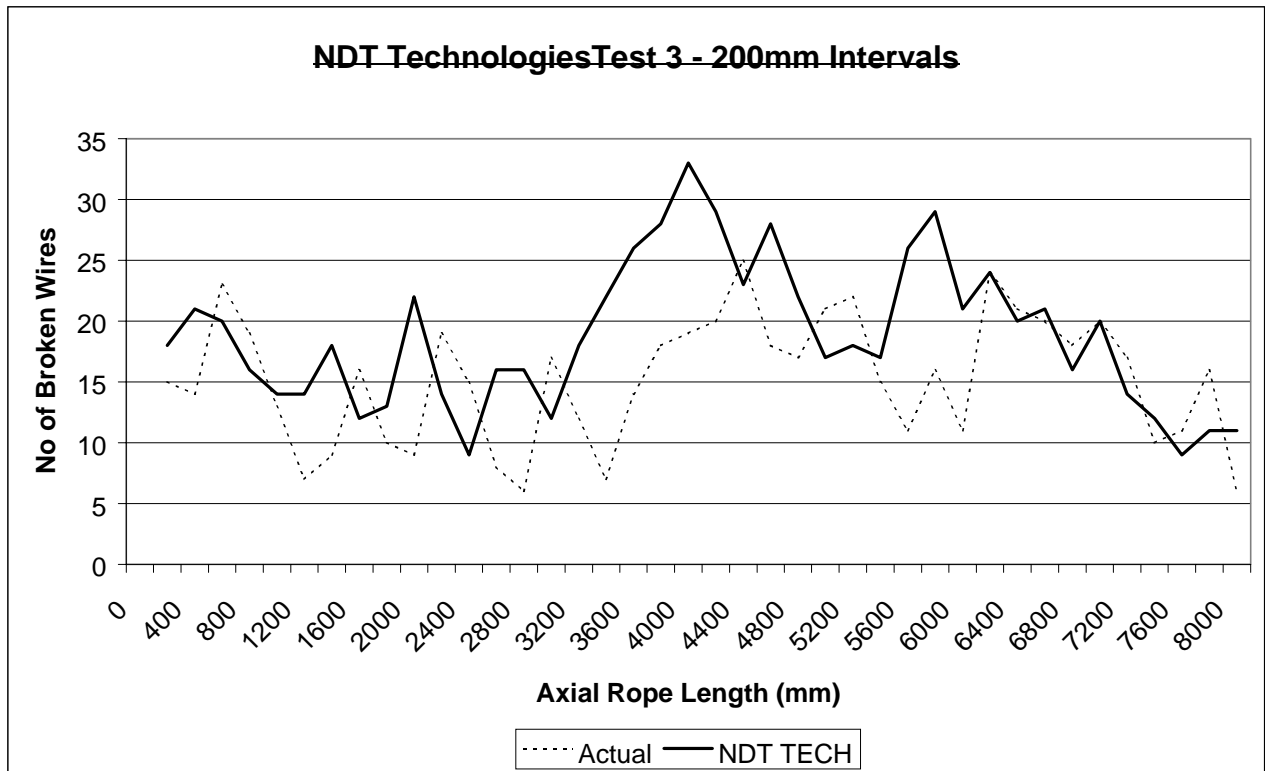

**Figure 4.2.1.4.2(b) NDT Technologies: Broken wire comparison for Test 3 at 200 mm intervals.**

#### 4.2.1.4.3 Comment by NDT Technologies

The detection and quantitative characterisation of broken wires in wire ropes with many breaks and clusters of breaks – such as Rope 1 – pose serious problems. These difficulties are caused by the fact that, for electromagnetic wire rope inspections, the indication of a broken wire is influenced by a number of parameters like

- (a) broken wire cross-sectional area,
- (b) broken wire gap width, and
- (c) by the position of the broken wire in the cross-section of the rope.
- (d) for clusters of broken wires, an additional problem is caused by the fact that the relative position of broken wires with respect to each other along the length of the rope is not known. For example, the gaps of broken wires could be aligned or staggered.
- (e) **broken wires with zero or tight gap widths are not detectable by electromagnetic inspections because they do not produce a sufficient magnetic leakage flux.**

Considering the above, only an estimate of the number of broken wires is possible.

For most rope testers, only one signal (the LF signal) is available for the characterisation of broken wires. This does not allow the determination of broken wire parameters such as cross-section, gap width, radial position in the rope, etc, an ambiguity, which, in turn, prevents the determination of the number of broken wires. This situation is analogous to the mathematical problem of determining a plurality of unknowns from only one equation, a problem that does not have a unique solution.

Another difficulty is that the LF signal is usually the first or second derivative of metallic cross-sectional area, and, therefore, not quantitative. An analogy can illustrate this problem: The height of a mountain cannot be determined with an instrument that can only measure its slope.

In contrast to other competing rope testers, for LMA-Test™ instruments, the LF signal is derived from the LMA signal. Therefore, the resolution of the LMA signal is as good as that of the LF signal. Actually, the LMA signal appears better suited than the LF signal for quantitative cross-section measurements and for estimating the number of broken wires.

Some peculiarities must first be considered when characterising broken wires by using the LMA signal. For example, the gaps of a certain number of broken wires can be staggered or distributed in many different ways over short distances that are shorter than the broken wire recovery length of a rope. (These gaps could even be completely aligned). In any case, the strength loss caused by broken wires is approximately the same, irrespective of the axial distribution of broken wires within a particular, relatively short, interval.

Therefore, if the LMA trace is used for broken wire evaluation, not only the LMA caused by wires *per se*, but also the length, over which the LMA occurs, are important. Both variables, LMA and its axial distribution, must be considered for the evaluation of broken wire clusters. This is taken into account in the following charts.

These charts (see figure 4.2.1.4.3) use rectangles to represent the number of broken wires in intervals along the length of Rope 1. The base of each rectangle indicates the length of the interval considered (in the present case, 100 mm) and its position with respect to the reference marker. The height of each rectangle indicates the relative number of broken wires ( $N/N_{\max}$ ) within the respective interval. Here,  $N$  denotes the number of broken wires in a specific interval and  $N_{\max}$  denotes the maximum number of broken wires in any interval along the length of Rope 1.

Note that the absolute number of broken wires ( $N$ ) per interval can be determined only after the parameters (height and width) of one or more of the rectangles in the following figures have been experimentally determined. This *calibration* must be performed by opening the rope and counting the broken wires in at least one interval. This way, a *calibration factor* (relating the number of broken wires in an interval to the average LMA over the same interval) for a rope can be determined, It is anticipated that the same *calibration factor* can then be used for all ropes of the same construction.

An estimate of the number of broken wires in each 100 mm interval is required by the contract. There are some indications that an estimate for the maximum number of broken wires per 100 mm of rope length of  $N_{\max} = 20$  might not be unreasonable. This guesstimate is based on a detailed examination of the LF traces and their respective derivatives from the annular coil inspections. Note, however, that a *calibration* of the LMA trace in terms of broken wires, as described, promises more accurate and reliable results.

The described approach is proprietary to NDT Technologies, Inc., and unverified at this point. The data on broken wires that will become available after Rope 1 has been deassembled will be valuable for establishing the viability of the proposed method and for establishing the viability of the proposed method and for establishing an appropriate *calibration factor* for Rope 1.

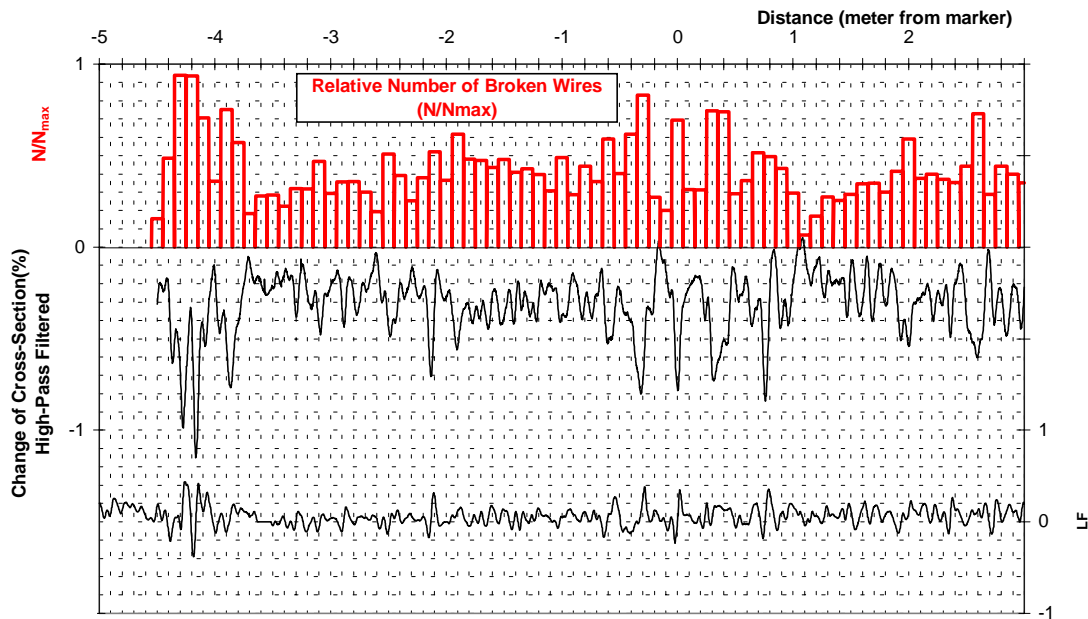

**Figure 4.2.1.4.3: NDT Technologies: LMA and LF traces and relative number of broken wire  $N/N_{max}$**

## 4.2.1.5 Universität Stuttgart

### 4.2.1.5.1 Test 2 results

Personnel from the University identified 42 broken wires in the 8 m rope sample. This represents 7% of the actual number of broken wires in the rope. The report submitted to the researcher identified each broken wire in relation to the marker.

The details of the results are shown in Appendix 1 and figures 4.2.1.5.1(a) and 4.2.1.5.1(b) below.

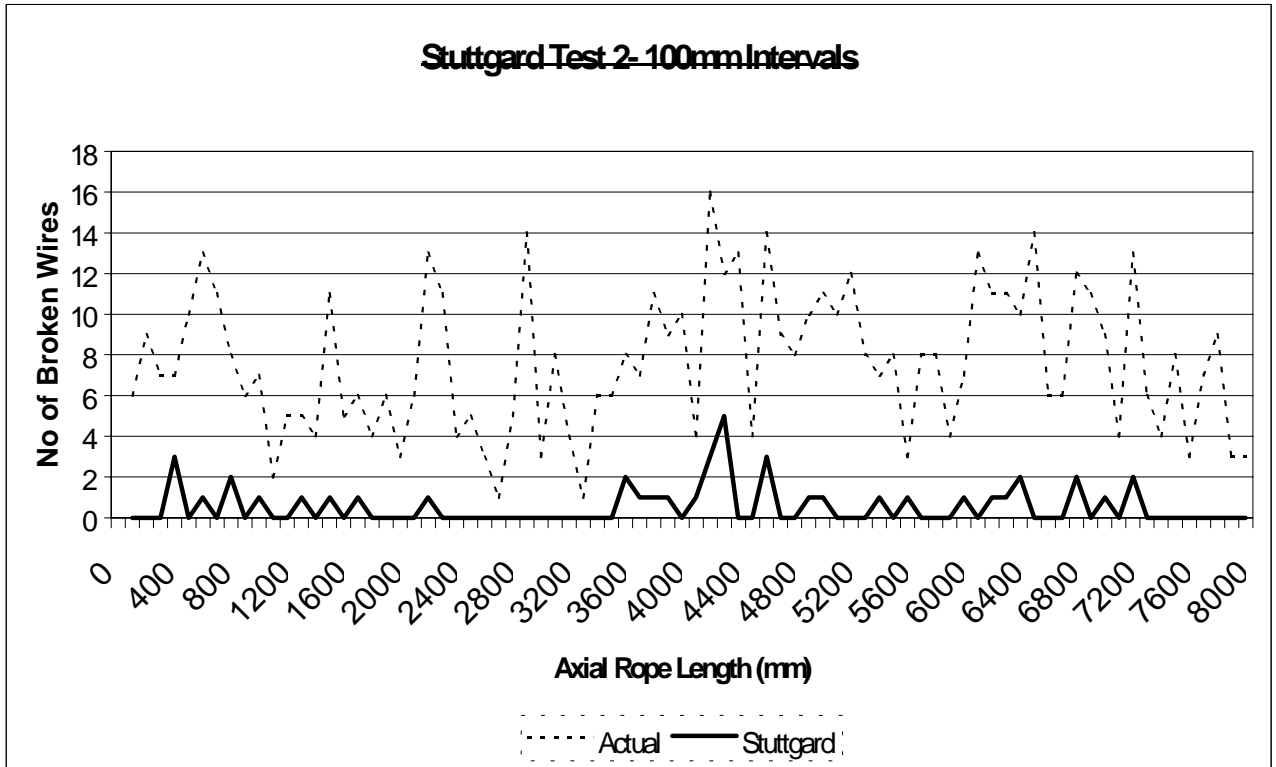

**Figure 4.2.1.5.1(a) Stuttgart Universität: Broken wire comparison for Test 2 at 100 mm intervals.**

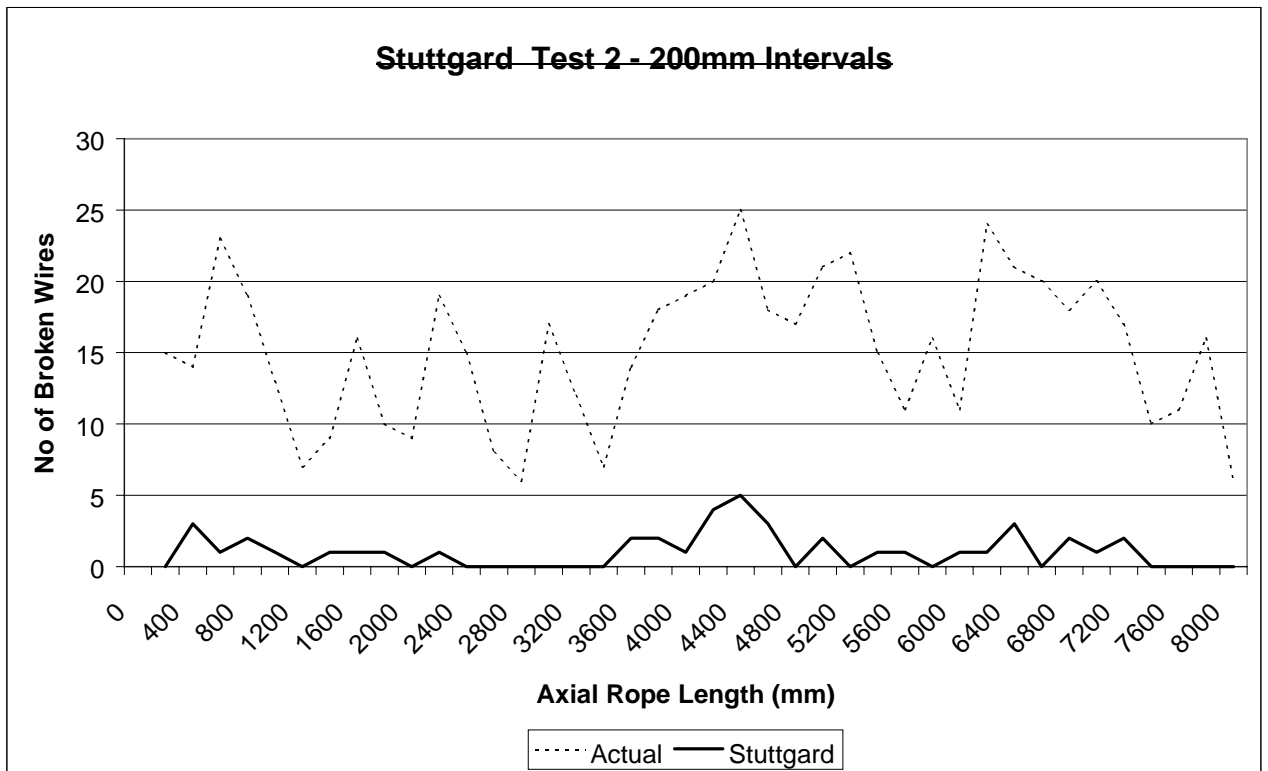
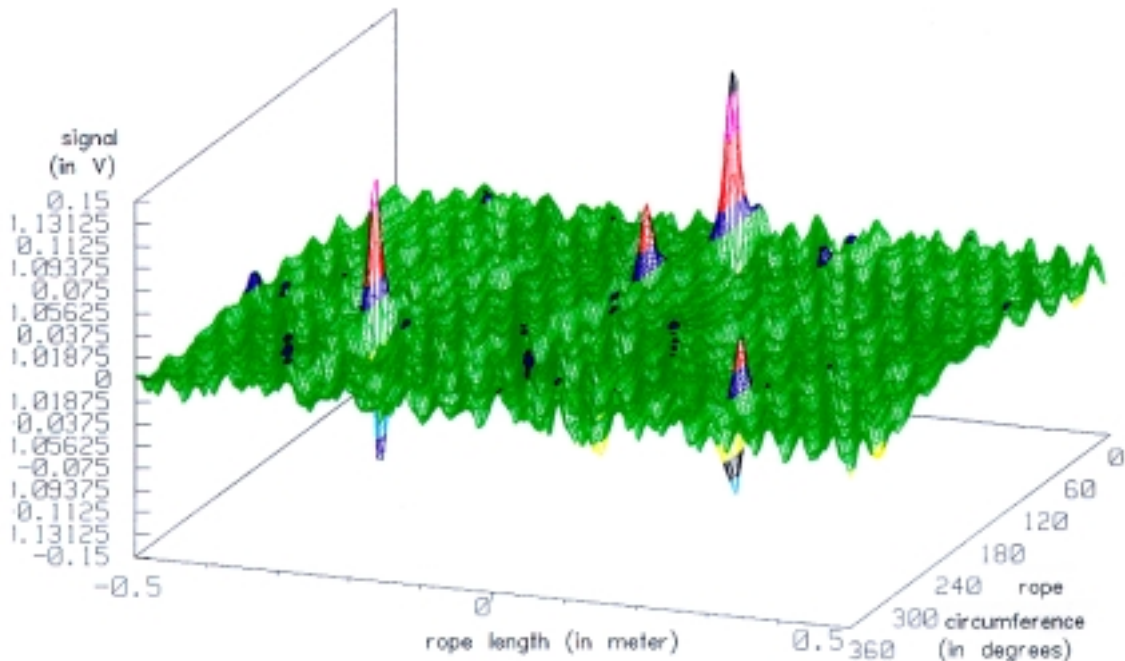

**Figure 4.2.1.5.1(b) Stuttgart Universität: Broken wire comparison for Test 2 at 200 mm intervals.**

Little comment can be made regarding the graphs except that some spikes in the graphs correspond.

#### 4.2.1.5.2 Test 3 results

The Stuttgart Universität rope inspectors also tested the rope using the “Hochauflösende magnetische Seilprüfmetode” as described in section 4.1.1.5 in this test. The inspectors identified the same number of broken wires using this method as they did using their normal instrument. Figure 4.2.1.3.2 shows a black and white rendition of a 3D scan.



**Figure 4.2.3.2 DMT – 3D scan**

#### 4.2.1.5.3 Comments by Stuttgart Universität

No comments were received.

#### 4.2.1.6 AATS

##### 4.2.1.6.1 Test 2 results

##### 4.2.1.6.1.1 Test 2 results – AATS instrument

The AATS team identified 341 broken wires in this rope sample, which equates to 56% of the actual number of broken wires. Some anomalies were classified as “large”.

Each broken wire identified was referenced to the marker.

The results are reflected in Appendix 1 and figures 4.2.1.6.1.1(a) and 4.2.1.6.1.1(b) below.

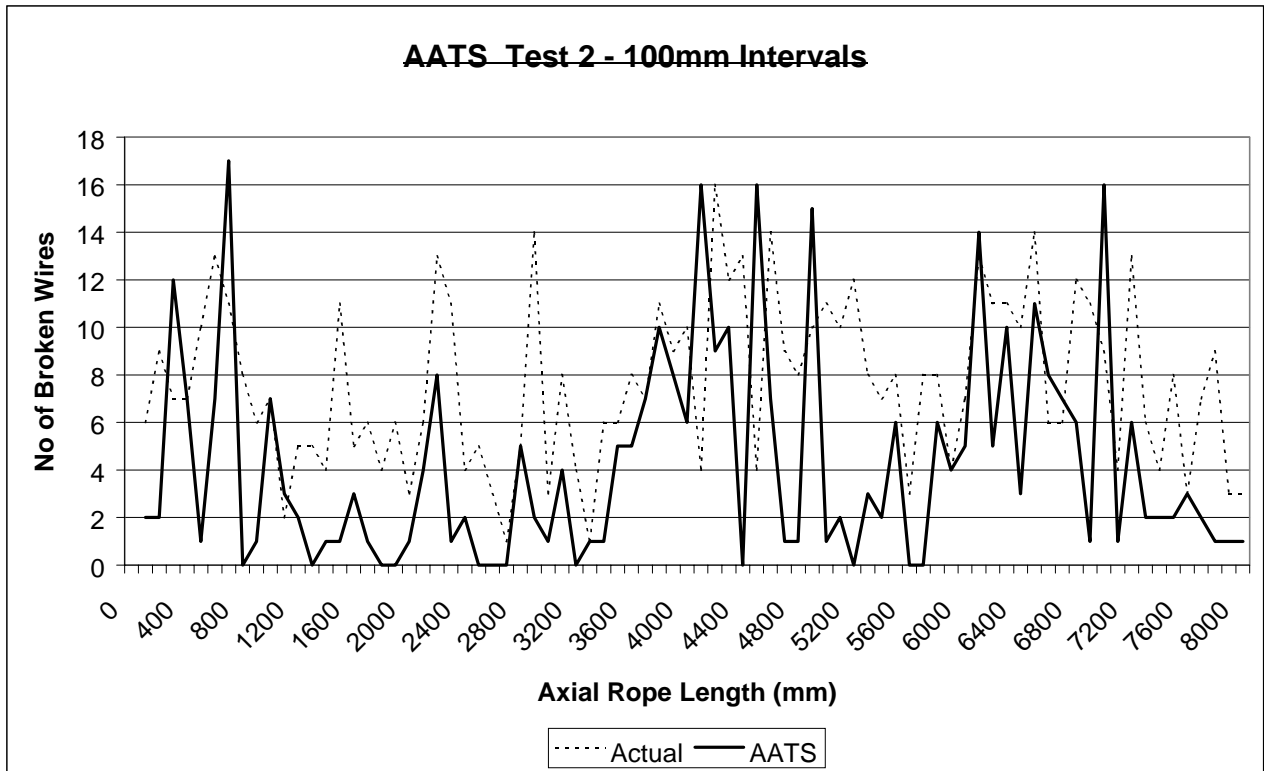

**Figure 4.2.6.1.1(a) AATS: Broken wire comparison for Test 2 at 100 mm intervals.**

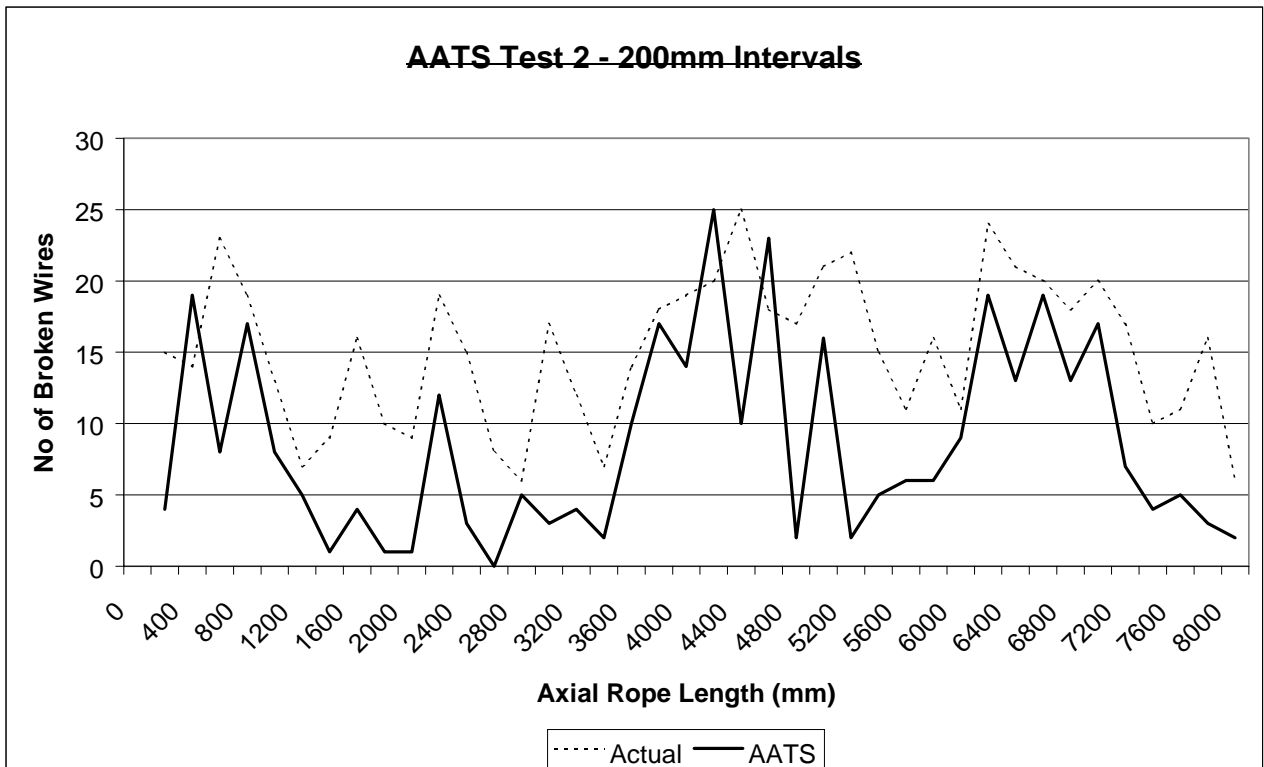

**Figure 4.2.6.1.1(b) AATS: Broken wire comparison for Test 2 at 200 mm intervals.**

These results indicate correlation between some of the peaks. In these graphs an offset between peaks is noticeable which may also indicate a problem with the axial measurement system of the instrument. As with the NDT Technologies results, an understatement of the number of broken wires in the 5 200 mm area is evident.

#### 4.2.1.6.1.2 Test 2 results – RMS instrument

AATS personnel repeated the test using a second instrument. This instrument is directly coupled to a chart recorder and the analysis of the results was entirely dependant on the chart speed. (Chart speeds have been increased subsequent to these tests).

The results were submitted in terms of “number of broken wires per 200 mm interval”.

Details are shown in Appendix 1 and in figure 4.2.1.6.1.2 below.

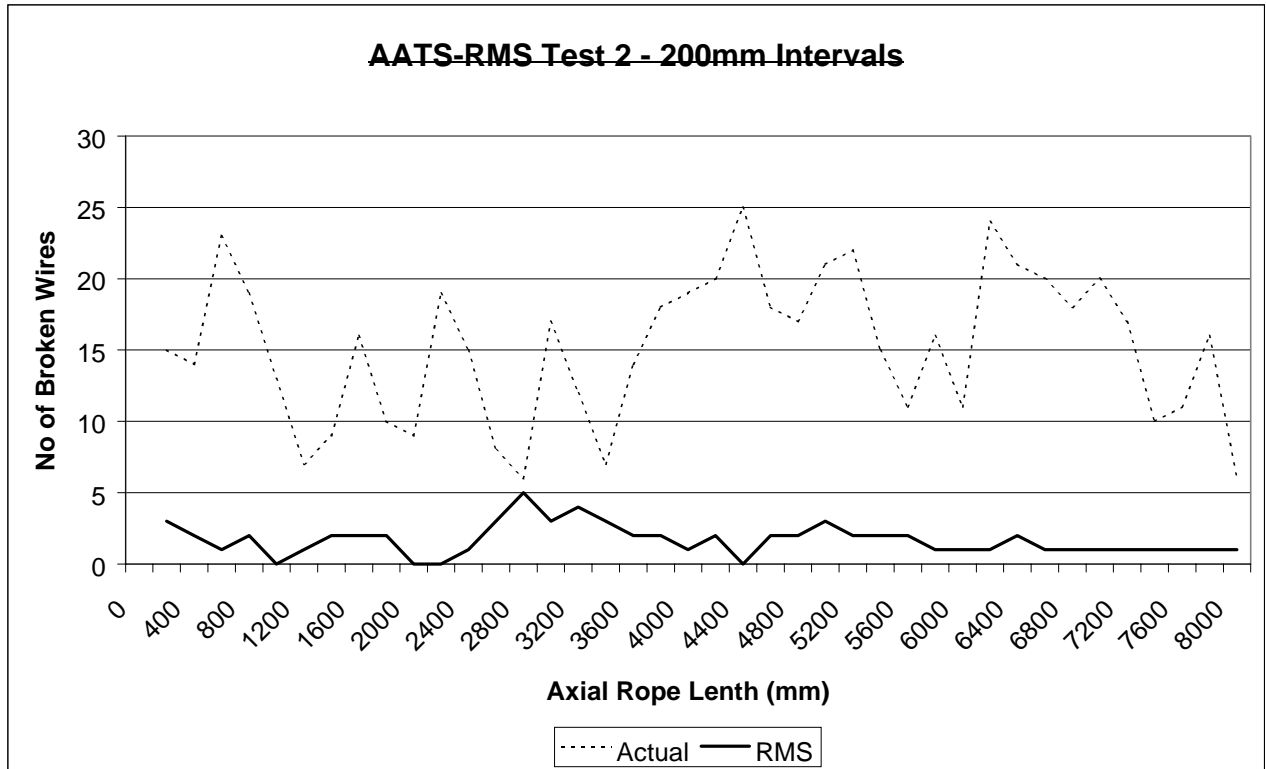

**Figure 4.2.1.6.1.2 AATS – RMS: Broken wire comparison for Test 2 at 200 mm intervals.**

#### 4.2.1.6.2 Test 3 results

No results were submitted.

#### 4.2.1.6.3 Comments by AATS

No comments were received from AATS personnel.

## 4.2.1.7 Meraster

### 4.2.1.7.1 Test 2 results

The rope inspectors from Meraster identified 19 anomalies in the rope sample. These anomalies were each referenced in mm from the marker. Each anomaly was described, for example

- accumulated broken wires of inner strand
- accumulated broken wires of rope core
- inner, 2 or more wires
- WMC, 2 or more wires
- outer, 2 or more wires.

The researcher was unable to obtain a more detailed breakdown of the number of broken wires identified by Meraster.

The results are listed in Appendix 1 with the description of the various anomalies.

Figures 4.2.1.7.1(a) and 4.2.1.7.1(b) below reflect the results in graphical format.

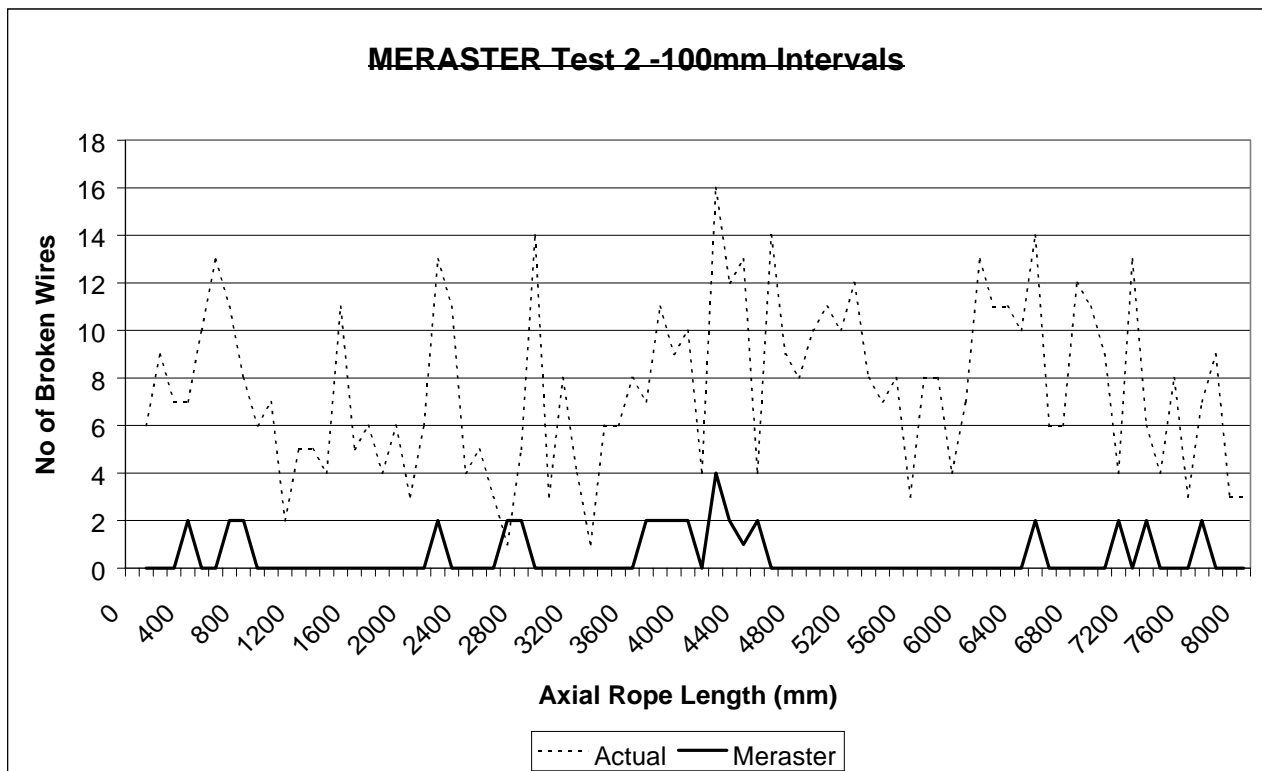

**Figure 4.2.1.7.1(a) Meraster: Broken wire comparison for Test 2 at 100 mm intervals.**



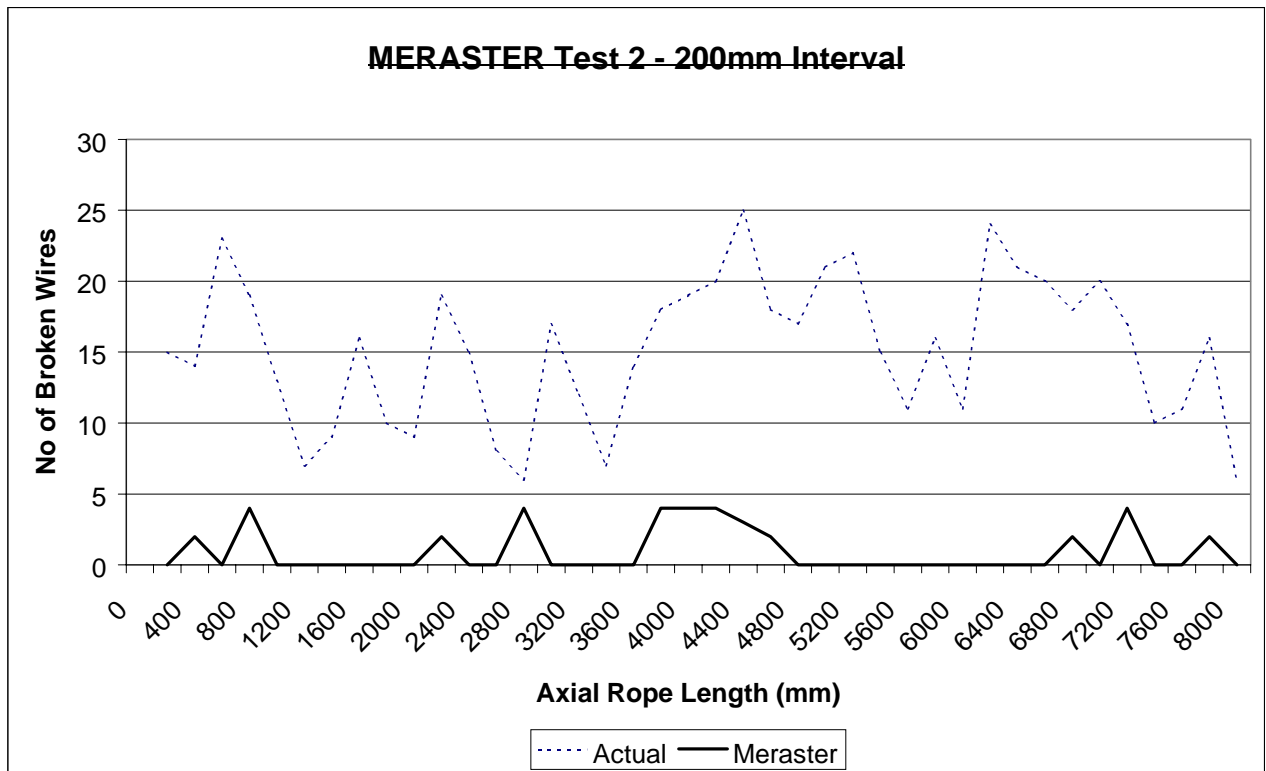

**Figure 4.2.1.7.1.(b) Meraster: Broken wire comparison for Test 2 at 200 mm intervals.**

Little comment can be made by the researcher regarding these results. Detailed analysis of the values stated in Appendix 1 does not indicate a correlation between the location of the anomalies indicated by Meraster and those actually present in the rope.

#### 4.2.1.7.2 Test 3 results

No results were submitted.

#### 4.2.1.7.3 Comment by Meraster

The grease on the rope surface effected a slip between the rope and the speed sensing rubber roller. This slip caused measurement errors reflected in the distance indicator and speed compensation of the measured signals of inner and outer coils.

Slip correction factors were however calculated and corrected values of the distance, inner and outer channel indications were submitted.

Meraster also noted that internal broken wires accumulated close to each other generate complex signals who's amplitude depends on the distribution and number of broken wires. These relations are very complex making precise identification of broken wires very complex.

#### 4.2.1.8 Rotesco

##### 4.2.1.8.1 Test 2 results

Rotesco identified no broken wires in the rope sample.

#### 4.2.1.8.2 Test 3 results

A solenoid coil was wound into the instrument for this test. Using this method no broken wires were positively identified on the rope.

#### 4.2.1.8.3 Comments by Rotesco

a) Position and number of broken wires identified in the rope, referenced from the market (Rotescograph Test)	No broken wires were positively identified in the rope from the Rotescograph Test Results. None were identified because the signals from the broken wires, if there were any, were masked or were indistinguishable from the signals caused by other types of deterioration, which appeared to be wear and possibly internal nicking.
b) Position and number of any additional broken wires identified in the rope from other tests (Solenoid test)	A 64 mm diameter solenoid coil was placed inside the Rotescograph Test Head and the rope was tested using this solenoid coil. The output from the solenoid coil was integrated to provide a signal of the loss of metallic cross-sectional area. Based on the test results from the solenoid coil, no broken wires were positively identified in the rope. None were identified because the signals from the broken wires, if there were any, were masked or were indistinguishable from the signals caused by other types of deterioration, which appeared to be wear and possibly internal nicking.

The rope was non-destructively tested using a standard Rotescograph test head with a minimum air gap of 5 mm between the rope and the test head and at a test speed of approximately 0.5 m/sec.

The pattern of metallic losses could be consistent with deterioration due to wear, where the regularity of the pattern is associated with the construction of the rope, an irregularity in the lay of the rope, and/or a characteristic of the hoist installation (sheave wheel, winding drum, etc). These patterns in some situations could also be attributed to corrosion, where some condition of the construction and lubrication of the rope caused the corrosion to occur in a somewhat regular and periodic pattern of localised metallic losses. In this case, since significant peening and wear was evident on the surface of the rope and corrosion was not evident, corrosion was not considered to be the most likely cause of the chart patterns.

If there are broken wires in the rope patterns associated with the broken wires are masked or are indistinguishable from the patterns due to the wear (or corrosion). This conclusion is based on the following:

A) Artificial defects representing broken wires of various gap widths and sections of wear of various profiles were made in steel rods and run through the test head in such a way as to represent internal and external defects in a rope. The results demonstrated that internal broken wires with gap lengths which might be expected would be difficult to distinguish from wear (or localised corrosion patches) which occurs as periodic metallic losses of relatively short length.

B) Test charts of actual ropes which are known (as determined by destructive tests) to have deterioration due to wear and have few or no broken wires have LF and LMA patterns which are similar in nature to that of the test chart of the 48 mm rope sample.

## CONCLUSIONS

- 1) It is our opinion that we were unable to positively identify any broken wires in the rope sample because another form of deterioration (which we suspect is external wear and possibly some internal wear and nicking) masked any broken wire signal patterns.
- 2) We are not sure if we would be able to positively identify broken wires in a similar rope which did not have other forms of deterioration such as wear, but it is our opinion that we probably could. We think that a broken wire pattern would be identifiable in the LF signal of the relatively undeteriorated section. If in fact the situation is that test patterns due to wear are obscuring the test patterns due to broken wires, it may be that one (probably impractical) solution to the problem would be to develop winder and sheave wheel technology (larger diameters, etc) which would minimise wear on the rope.
- 3) Another solution to the problem may involve segmented LF sensors (at least 4 individually recorded LF sensors located around the circumference of the rope). By processing the signals from the segmented LF sensors with suitable analytic software (which would need to be fairly sophisticated), it should be possible to separate the LF signals which are originating from close to the centre of the rope (the broken wires) which should produce signal components which are approximately equal in all of the LF sensors, from the LF signals which are caused by deterioration on or near the surface of the rope which would produce different signal components in each of the LF sensors.

### **4.2.2 Results of Test No 1**

The detailed results of Test No 1, the comparison of the traces at different instrument velocities and directions, are reflected in Appendix 5.

As stated in 4.1.2, a quantitative comparison of the traces is extremely difficult. Two persons assessed the various traces qualitatively.

The analysis of the traces again indicated that the velocity of the instrument and the direction of travel influenced the output signal of certain of the instruments. This can affect the repeatability and accuracy of the rope condition assessment.

### **4.2.3 Remaining strength of section TP1**

The rope condition assessment contractors were all requested to determine the remaining strength of the rope section designated as TP1 in the 48 mm rope sample.

Only one took the challenge:

BREAKING STRENGTH OF NEW ROPE	STRENGTH OF TP1	% REDUCTION IN STRENGTH
Breaking strength of new rope	2080 kN	
Actual remaining strength as determined by destructive test	1452,7 kN	30,2%
Noranda	-	-
Lloyds Beal	-	-
DMT	-	-
NDT Technologies	-	-
Universität Stuttgart	-	-
AATS	-	-
Meraster	-	-
ROTESCO		4% to 6%

**Table 4.2.3 Remaining strength comparison of 48 mm rope, TP1**

The fact that only one contractor tried to estimate the remaining strength of the rope sample gives an indication of the complexity and difficulty in estimating the remaining strength of ropes.

Rope inspectors should at least have stated that the rope is way beyond the 10% discard limit required by the South African regulations and the regulations of many other countries.

### **4.3 DMT experimental rope containing artificial defects**

The DMT made their in-house experimental rope available for further tests to all of the rope inspection organisations which took part in the Bochum experiment. The experimental rope is a multiple oval, flattened strand rope of 48 mm diameter and SES-U+7x[1+6+(6+6)+16] construction. The rope is mounted on a vertical position and the test heads are moved up and down over the rope by means of a crane.

The rope has a number of artificial defects built into it ranging from single broken wires to a broken core.

All 8 rope inspection teams were able to identify every anomaly in the rope.

## **5 Analysis and discussion**

### **5.1 Corroded rope sample**

5.1.1 The wide variation in the remaining strength values submitted by the different rope inspectors gives an indication of the complexity and the unknowns inspectors have to contend with when deriving the remaining strength of corroded rope sections. The wide spread of results further indicates the lack of international standards for the condition assessment of corroded ropes.

5.1.2 The loss of metallic area (LMA) determined by the various rope inspectors varied considerably. It must be noted that the percentage LMA is a relative measurement. It is usually a comparison of the measured metallic area (MA) in one section of the rope (usually a “good” section of rope where the instrument is calibrated) with the measured

MA in another section of the rope (the deteriorated section). The measurement of the LMA should be relatively straight forward.

Yet the values presented for %LMA varied from 9% to 45%, in relation to the good section of the rope. This indicates that calibration and measuring procedures are not universal nor adequate. Different instruments used to measure the same rope section should at least give reasonably similar LMA values.

- 5.1.3 The derivation of the loss of breaking strength (LBS) was presented in different ways by the different rope inspectors. Some of the experts used formulas to calculate the LBS, others used graphs, some multiplied the LMA value by two while others halved the LMA value they had recorded. One inspector gave the remaining strength estimate within a very wide tolerance band (between 28% and 50% LBS).

The rope condition assessment experts calculated LBS values of between 9% and 50%. This must be compared to the actual value of 48,3% LBS established by destructive testing.

The above also indicates a lack of consistency in the methodologies and standards rope inspectors apply to determine the loss of breaking strength. This fact should be of grave concern to users employing ropes in critical applications.

- 5.1.4 It is heartening to note that all the inspectors, bar one, estimated the LBS of the corroded section to be more than 10%. This would have led to immediate discard of the rope in terms of the South African regulations. It is however questionable at what % LBS the rope would actually have been removed from service given the varied results presented by the different inspectors.

- 5.1.5 The researcher is not keen on relying on the proprietary algorithms proposed by certain inspectors for assessing the condition of ropes. These proprietary algorithms lead to a “black box” approach. The user of the instrument does not understand the reason for rope discard when using this proprietary technology built into the instrument.

For the algorithms to be trusted every combination of rope construction, deterioration mechanism, rope diameter, tensile grade and instrument characteristic needs to be tested and compared to the actual LBS of the ropes under review to demonstrate the reliability of the algorithm.

In the South African context, the researcher has seen instances where the LMA traces indicated very little signs of deterioration and the LF trace showed no anomalies, yet the ropes had lost more than 35% of their original breaking strength. The loss in these instances was due very localised abrasion of the crown wires over a short section of the rope.

It is therefore imperative to visually examine all indications of anomalies diligently and to combine the results obtained by the visual examination, measurements and magnetic tests with the in-depth experience of the rope inspector. The researcher suggests that the “black box” approach be avoided at all costs.

- 5.1.6 The South African Bureau of Standards Code of Practice 0293: 1996 “Condition assessment of steel wire ropes on mine winders” states the following:

#### 5.6.1 Loss of strength

Where the calculated loss of strength owing to corrosion is based on magnetic measurement of rope steel area, the indicated loss of steel area shall be multiplied **by the conversion factor for the specific rope construction and**

instrument combination used (see 6.5.3). The loss of rope strength so calculated shall not exceed 10% of the new rope breaking strength.

#### 5.6.2 Pronounced pitting or roughening

Pronounced pitting or roughening of outer wires that is caused by more than slight corrosion or worse (as illustrated in figures A.5 to A.8 of annex A) shall be reason for discard.

#### 6.5.3 Corrosion

Magnetic tests and visual examinations shall be used to detect the presence of corrosion and to assess the degree of deterioration of the rope. (Corrosion can give rise to repeated high-frequency random variations in the broken-wire trace and to variations in the steel-area trace and contact trace (see 8.1.7). Variations in diameter and in lay length can also be caused by corrosion.

Where internal corrosion is suspected or is confirmed by internal examination of the rope, the loss in rope strength shall be derived from the loss in steel area indicated by a magnetic instrument, multiplied by the conversion factor applicable to the instrument and rope construction combination. Great care needs to be exercised when the conversion factor for a particular rope/magnetic instrument combination is being derived. Cognisance shall be taken of the variable influence of corrosion on rope strength. Practical tests have indicated a wide spread of loss of rope strength for similar magnetic instrument traces. Winding rope inspectors shall give careful consideration to the above when calculating the loss of strength in a rope because of corrosion.

The code of practice provides good guidelines for establishing the condition of corroded ropes by means of NDE, even though it is a time consuming process.

## 5.2 Assessment of the broken wire rope sample

5.2.1 Although the researcher attempted to choose the “best” rope sample, with the least number of broken wires, from the samples available for the experiment, the chosen rope still contained up to 24 broken wires/100 mm rope length at the worst spot. The 8 m section of the rope sample, which was subjected to intense analysis, contained 609 broken wires. The rope inspectors identified between 0 and 750 broken wires in the same 8 m rope sample applying NDE methods.

It must be noted that the ropes from which the samples were cut were in service on a mine until discarded in terms of the discarded criteria available at that time (1993). The same discard criteria apply today.

The large number of broken wires contained in the rope probably made the examination and analysis of the rope condition more difficult than having fewer broken wires.

5.2.2 The results of the experiment clearly indicate that the rope inspectors were unable to identify each broken wire in the rope accurately. Two of the inspectors were able to identify a large percentage of the broken wires. It must however be noted that both these contractors were unable to identify the numerous clusters of broken wires situated around the 5200 mm mark.

5.2.3 The lack of response by rope inspectors to estimate the remaining strength of a portion of the rope gives a clear indication that inspectors are loath to derive remaining strength estimates for any ropes. Only one rope inspector calculated the LBS at between 4% and 6%. Actual LBS was determined by destructive test to be 30,2%.

The comments by various rope inspection companies, as related in the main body of this report, supports this view.

### 5.3 Alternative instrument configurations

The results clearly indicate that the annular coil configuration coupled with small airgaps improves the sensitivity of the instruments. This configuration is however impractical in the field.

### 5.4 Effect of instrument velocity and direction on the output signal

Some instruments under review showed no or little effect on the output signal by varying the velocity or direction of the test head within the specified limits.

A number of instruments, however, indicated that the speed and direction of the test head does have a marked influence on the signal trace. The variation in trace output due to variations in speed and direction can influence the accuracy and repeatability of the rope condition analysis in the field.

### 5.5 Loss of breaking strength as a discard criteria

A number of the rope condition assessment companies commented that the loss in breaking strength criteria is unacceptable. The researcher, however, believes that the loss in breaking strength is the only quantitative value which gives an absolute indication of the condition of a rope. All other measures are subjective.

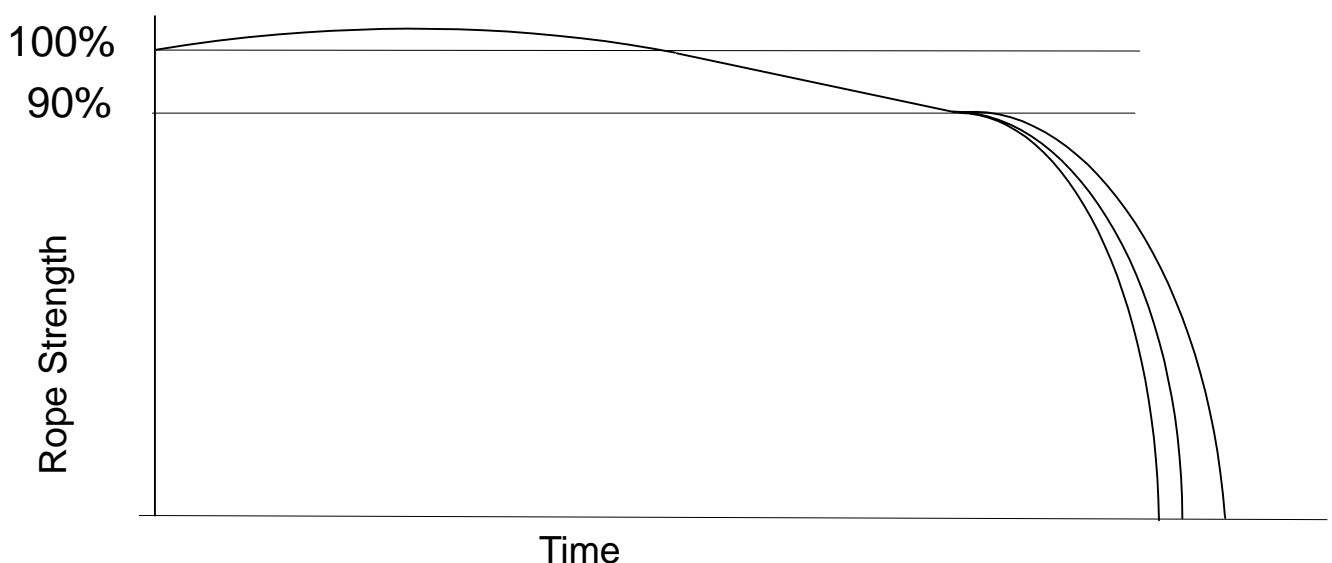

Figure 5.5 Rope deterioration over time

For this reason Governments, around the world, have set discard levels for ropes at very modest loss in breaking strength values. Most regulations set the discard value at between 10% and 15% LBS. This, coupled with frequent inspections, which usually increase in frequency towards the end of a rope's life, has led in safe hoisting over many decades.

Given the results obtained in the Bochum experiment, the researcher suggests that the 10% LBS discard criteria remain in force.

## **6 Conclusions**

### **6.1 Corroded rope sample**

- 6.1.1 The loss of breaking strength (LBS) values presented by the various rope inspectors varied between 9% and 50%. This clearly indicates the complexity inspectors have to deal with when determining the LBS of corroded ropes and the lack of standards.
- 6.1.2 The large variation in the loss of metallic area (LMA) determined by the inspector, between 9% and 45%, indicates that calibration procedures and measuring procedures are not adequate nor universal.
- 6.1.3 The wide variation in the methodologies of calculating the loss in breaking strength (LBS) indicates a lack of consistency in the procedures and standards rope inspectors apply.
- 6.1.4 Inspectors must be wary of implementing a "black box" approach, proposed by certain instrument suppliers, when assessing the condition of corroded ropes.
- 6.1.5 The SABS 0293 guidelines for assessing the condition of corroded ropes provide a good basis for rope NDE, even though it is time consuming and laborious to conform to these guidelines.

### **6.2 Broken wire rope sample**

- 6.2.1 Magnetic rope test instruments are not able to identify each wire break within multi-layer, low rotation ropes.
- 6.2.2 The results indicate that instruments are not capable of pin pointing broken wires accurately, not even to the nearest 20 mm, along the axial length of the rope.
- 6.2.3 From the material presented by the rope inspectors it is obvious that it is not possible to ascertain the radial position of the broken wires within multi-layer, low rotation ropes.
- 6.2.4 Given the above, it must be concluded that it is not feasible to implement discard criteria for multi-layer, low rotation ropes based on the premise that the accurate identification of the axial and radial position of wire breaks within the rope by means of magnetic NDE is possible.

This casts doubt on the applicability and usefulness of the discard criteria derived in GAP502.

- 6.2.5 As stated in the conclusion to the literature search, a vast amount has been written about non-destructive rope testing and many successes have been claimed in this field. Application of high-tech computerised systems are seen to be able to automate and



deskill rope NDE. The experiment conducted at Bochum however indicates that rope NDE in practice is not as advanced as claimed in the literature.

## 6.3 General

The researcher noted that the output signals from several instruments was influenced by the speed and the direction in which the test head travelled. This can influence the NDE results negatively.

## 7 Recommendations

- 7.1 Discard criteria for multi-layer, low rotation ropes must not be based on the premise that internal broken wires can be identified with any degree of accuracy employing current NDE technology.
- 7.2 The applicability and usefulness of the discard criteria developed for multi-layer, low rotation ropes in the GAP502 project must be reviewed in the light of the results obtained in the work described above.
- 7.3 The rope condition assessment (RCA) fraternity must develop different discard criteria, methodologies and procedures to assess the condition of multi-layer, low rotation ropes exhibiting internal broken wires.
- 7.4 RCA inspectors, world wide, must develop universally accepted procedures to assess LMA and LBS. The results of most other NDE techniques, employed world wide, are independent of the instruments used or the personnel involved. Proper and consistent calibration, instrument set-up and procedures are employed to ensure repeatability and consistency of results. Universally accepted rope inspection procedures must be established to form the basis for all RCA work.
- 7.5 Rope condition assessment (RCA) inspectors must be made aware of the severe limitations of their instruments when inspecting multi-layer, low rotation ropes.
- 7.6 RCA inspectors must be made aware of the complexities and the dangers associated with the inspection of corroded ropes. The guidelines contained in SABS0293 must be applied diligently when inspecting corroded ropes.
- 7.7 RCA inspectors must be made aware of the fact that some instruments give different trace outputs, for the same rope, when used at different speeds or in different directions. This could impact negatively on the reliability and consistency of the rope NDE.
- 7.8 The suppliers and manufacturers of instruments must ensure that their instruments give consistent signal outputs at different speeds and directions, within defined testing envelopes.
- 7.9 Instrument developers should, if at all possible, develop technologies which will lead to the accurate identification of internal broken wires within multi-layer, low rotation ropes.
- 7.10 The discard criteria for multi-layer, low rotation ropes currently contained in the SABS 0293 document are inadequate and must be revised.
- 7.11 The guidelines for assessing the condition of corroded ropes as contained in the SABS 0293 document are adequate and should remain in their present format.

## References

1. **Semmelink, A.** Electromagnetic Testing of Winding Ropes – SA Institute of Electrical Engineers Vol 44, Part 5 May 1953.
2. **Harvey, T and Kruger H.W.** The Theory and Practise of Electronic Testing of Winding Ropes. Transactions of the SA Institute of Electrical Engineers. June 1959.
3. **Kuun, T.C., May 1993.** Low rotation winding ropes for long lift drum winders. *Internal Anglo American of South African Limited document.*
4. **Rieger W.,** Ein Bietrag zur magnetinduktiven Querschnittsmessung von Drahtseilen – Institut für Fördertechnik – Universität Stuttgart, 1983
5. **Briem U.,** Verbesserungen der Ablegereifeerkennung laufender Drahtseile durch Kombination von Ablegekriterien, Institut für Fördertechnik – Universität Stuttgart, 1996.
6. **Jahne K.,** Zuverlässigkeit des Ablegekriteriums Draghtbruchzahl bei laufenden Seilen. Institut für Fördertechnik – Universität Stuttgart, 1992
7. **van der Walt,** Die elektromagnetiese toetsing van staaltoue met behulp van permanent magnete. Randse Afrikaanse Universiteit, 1988.
8. **Geller L.B., Udd J.E.,** How accurate are non-destructive testing based estimates of mine shaft rope breaking strength losses? – an update. *CIM Bulletin – December 1990.*
9. **Weischedel, H.R., Chaplin, C.R.,** Inspection of wire ropes for offshore applications. *Materials Evaluation Vol 49, No 03 pp 362 to 367 – 1991. The American Society for Non-destructive testing.*
10. **Weischedel, H.R. Chaplin, C.R.,** The inspection of Offshore Wire Ropes: The State of the Art. *24th annual Offshore Technology Conference, Houston, Texas, May 4-7, 1992.*
11. **Herbert R Weischedel.** The inspection of Wire Ropes in Service: A Critical Review. *Materials Evaluation – Vol 43 No 13 pp 1592 – 1605 – 1985 American Society for Non-destructive Testing.*
12. **Herbert R Weischedel.** The Inspection of mine hoist ropes. *Wire Rope News & Sling Technology. June 1991.*
13. **Herbert.R. Weischedel..** Wire Rope strength estimates, retirement criteria and electromagnetic inspection – a critical review. *Wire Rope News and Sling Technology Dec 1993.*
14. **Herbert.R. Weischedel..** Electromagnetic wire rope testers offer excellent inspection accuracy and allow economical and safe rope operations. *Wire Rope News and Sling Technology April 1997*
15. **Hamlin M, Kitzinger F. Rousseau G., Geller L. –** Techniques to better exploit the possibilities of wire rope testing with permanent magnetic equipped EM instruments. *Mine Hoisting 93, Conference papers – Second International Conference 28 – 30 June 1993, London.*
16. **Lorant B. Geller, F. Kitzinger, K. Leung –** NDT of Wire Ropes with a Novel, Computer-controlled, Dual function electromagnetic wire rope tester. *NDT Solutions March 1998.*

17. **Martyna R:** The effect of environment and other problems on the magnetic testing of steel wire ropes. *OIPEEC Round Table: Reading September 1997.*
18. **Hamelin M., Kitzinger F., Geller, L.B.,** Computer predictions of wire rope endurance based on NDT. *OIPEEC Round Table Reading —September 1997.*

# Appendix 1

## Details of the results of the NDE and destructive test of the broken wire rope sample

**Note:**       \*\*       refers to:    **A Twisted Triangular Strand Core**  
              \*       refers to:    **A Broken Triangular Strand Core**