

THE INFLUENCE OF BALLAST FOULING ON TRACK SETTLEMENT

A RAMPERSAD, T B GEORGE, R MOKOENA, M B MGANGIRA, P J GRÄBE*

Pavement Design and Construction, CSIR Built Environment, P O Box 395, Pretoria 0001,

Tel: + 27 (0)12 841 3831, Email: ARampersad@csir.co.za

Tel: + 27 (0)12 841 2924, Email: TGeorge@csir.co.za

Tel: + 27 (0)12 841 2933, Email: RMokoena@csir.co.za

Tel: + 27 (0)12 841 4499, Email: MMgangira@csir.co.za

*Department of Civil Engineering, University of Pretoria, Private Bag X20, Hatfield 0028

Tel: +27 (0)12 420 4723, Email: Hannes.Graabe@up.ac.za

ABSTRACT

The contamination of railway ballast (referred to as ballast fouling) is commonly caused by ballast particle degradation, external debris fouling due to surface spillage and clay fouling due to subgrade pumping. Intrusion of these fines in the ballast layer can impede rapid drainage which is necessary for good track performance. There is little research relating both fouled ballast and track settlement in a South African context.

This paper discusses the effect of coal contaminated ballast on track settlement by use of a large scale “box test” apparatus. A series of tests was conducted on ballast aggregate, typically used on heavy haul railway lines in South Africa, with varying percentages of coal dust material (0, 8.4, 16.9, 25.3 and 33.8 % by weight of aggregate). Testing was conducted at 10 Hz for 100 000 cycles with a moisture content of 5.0 %. Results indicated an increase in settlement of between 11.7 and 40.2 % per 10 % increase in coal dust contamination.

It is envisaged that this research will aid the South African railway industry in identifying the critical levels of coal fouling which will hence contribute towards reducing maintenance costs as well as improving railway safety and network reliability.

1 INTRODUCTION

Over R200 billion has been allotted to the South African Railway industry to expand its rail infrastructure in order to create capacity and to increase cargo volumes. The increase in future rail demand will result in an increase of coal, iron ore and general freight rail capacity by 44, 57 and 113 % respectively (Transnet, 2017). This increase in railway capacity will render the supporting track materials to more frequent cyclic loadings, leading to the degradation of ballast particles.

South Africa has a broad railway network which plays a significant role in the transportation of freight from coastal ports to inland cities. There are two main heavy haul lines in South Africa which transports coal (Broodspnyersplaas to Richards Bay) and iron ore (Sishen to Saldanha). It is important to understand how ballast fouling can hinder the reliability of a track structure as well as how optimising periodic maintenance times can lessen costs (Joubert, 2017).

Ballast screening is a maintenance action used for fouled ballast, which involves the removal, screening and replacement of worn ballast with fresh ballast using a mesh. Current local practice is to use a visual assessment score (rated as new, good, fair, poor or unserviceable) to assess the condition of ballast. There are currently no standards for a critical level of fouled ballast for which maintenance should occur (Transnet, 2017).

The purpose of this study was to relate the track settlement with the degree of ballast contaminated with coal dust using a large scale box test apparatus, mounted with Linear Variable Differential Transformer (LVDT) sensors for settlement measurements.

2 LITERATURE REVIEW

Huang et al. (2009) identified three critical phases of ballast fouling (Figure 1). The fine material occupies the void spaces between the ballast aggregates which may ultimately result in the loss of contact between the large ballast particles and subsequently contribute towards ballast settlement due to unstable track support conditions. Figure 1 illustrates three phases with varying degrees of ballast fouling occupying the void spaces. Phase 1 (Figure 1a) indicates the ballast sample almost free of any fouling materials, and the ballast particles establishing good contact with each other for effective load carrying ability. Although contact between the aggregate particles are still maintained in Phase 2 (Figure 1b), the presence of fouling material in the void spaces between the ballast aggregate is enough to significantly reduce the strength of the ballast aggregate skeleton. Phase 3 (Figure 1c) indicates a heavily fouled ballast condition, resulting in the loss of contact between the ballast particles which will undoubtedly affect ballast strength and hence compromise track stability.

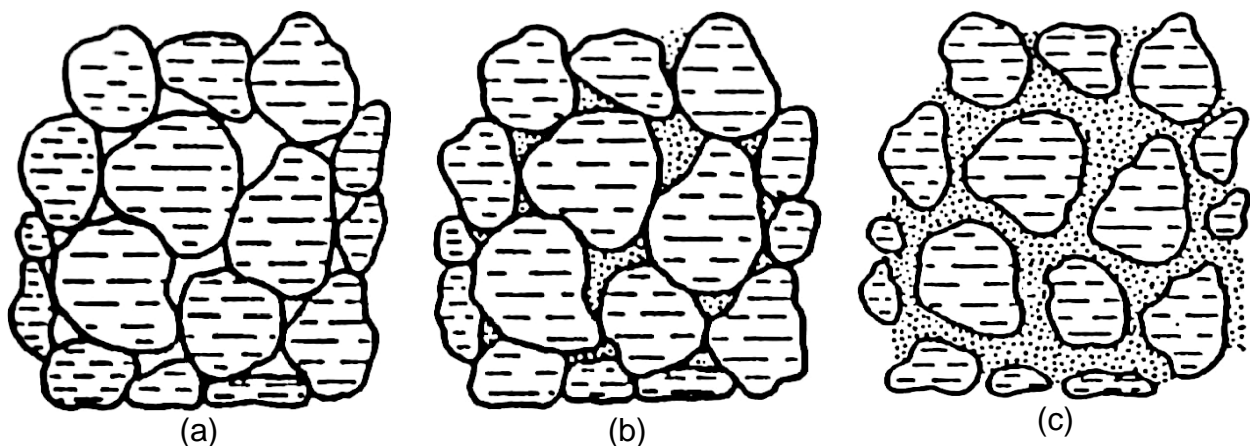

Figure 1: Critical ballast fouling phases: (a) clean ballast (Phase I), (b) partially fouled ballast (Phase II), and (c) heavily fouled ballast (Phase III) (Huang et al., 2009)

Han and Selig (1997) conducted a series of similar box tests to investigate the effect of fouling material and moisture content on ballast settlement. An increase in the degree of fouling resulted in an increase in ballast settlement. When moist clay and moist silt was used as a fouling material, the settlement was the same at 20 % fouling due to the development of cohesion as the fouling percentage increased. It was shown that an increase in water content in the clay sample will result in an increase in ballast settlement. The settlement increased rapidly for wet clay for fouling percentages above 20 %. Such settlements will affect performance of the tracks, including misalignment.

Qian et al. (2014) investigated the permanent deformation behaviour of fouled ballast material with a Fouling index (FI) of 40, caused by ballast degradation, by means of large scale triaxial tests. The results revealed that the total average permanent axial strain almost doubled for the fouled ballast material in comparison with the clean ballast material. The observed behaviour was attributed to the intrusion of the fine materials into the ballast void spaces which resulted in loss of particle-to-particle contact between the large ballast aggregates.

Huang et al. (2009) conducted an assessment on the effect of various fouling materials namely; coal dust, mineral filler and clay, on the ballast strength and deformation characteristics. A set of direct shear tests were conducted on clean and fouled ballast at varying levels of fouling under dry and wet (mostly at optimum moisture content) conditions. It was observed that lower ballast shear strengths were obtained under wet fouling conditions than under dry fouling conditions. Further observations revealed that 15% dry coal dust fouling by weight of ballast and 25% wet coal dust fouling by weight of ballast at 35% optimum moisture content demonstrated the highest reduction in shear strength. It was identified that water is retained by the fouling material which results in a build-up of pore water pressure and in turn contributes towards loss of strength and hence track instability.

Shear strength is decreased by the addition of fouling material as demonstrated by Dombrow et al. (2009) who used coal dust as the primary fouling material on granite and limestone ballast. Tests conducted under wet conditions were found to have significantly reduced shear strength. Indraratna et. al. (2011) studied the effect of coal fines on geogrid-reinforced ballast using large-scale shear box tests with Void Contamination Indices ranging from 0% - 95%. The introduction of coal fines to the ballast and geogrid resulted in a decrease in shear resistance and apparent angle of shear resistance.

Kashani et al. (2017) studied the effect of fouled ballast and moisture content on elastic deformation and plastic settlement of ballast under cyclic loading. Their study demonstrated that highly fouled ballast, with high moisture content and subject to high axle loads caused large settlement in ballasted railway tracks. They also showed that results from the box tests correlate closely with field measured data. It was found that a 3% increase in the amount of water content quadruples the rate of settlement in moderately fouled ballast (15% fouled by weight).

Selig & Waters (1994) showed that ballast breakdown accounts for the majority of fouling material (on average 76%) followed by infiltration of sub-ballast (13%), infiltration from surface ballast (7%), subgrade intrusion (3%) and sleeper wear (1%). However, Feldman & Nissan (2002) showed that coal infiltration is the major component of ballast fouling on an Australian railway track mainly used for coal.

Ballast contamination or the fouling of ballast due to ballast degradation (fine particles migrate downwards) or external sources (coal dust from rail cars), as well as ballast settlement can affect the function of the ballast (Anbazhagan et.al, 2012). Fouled ballast can impede rapid drainage which is necessary for track performance. With the inclusion of a large amount of fouling material in the ballast, the grading may change and hence contribute in the settlement of the ballast. Ballast that has settled will hinder the purpose of the ballast to provide void storage and resiliency (Wenty, 2017, Anbazhagan et al. 2012).

Anbazhagan et. al. (2012) reviewed the impact of ballast gradation as a form of fouling. It was found that poorly graded ballast is more favourable for drainage but may not be

favourable for stability and settlement. Fouling indices are specific to the ballast gradation and the types of fouling materials.

Limited research is available, relating fouled ballast and track settlement in a South African context. It is envisioned that this initial study will form part of research that will further South African standards and good practice for improving railway safety and network reliability.

3 TEST PROGRAM

The test program for the analysis of ballast settlement included material characterization, sample preparation, ballast fouling and performance testing.

3.1. Materials

3.1.1 *Ballast*

The material characterization of the ballast was done in accordance to Transnet S406: Specification for the supply of Stone (1998) standards. The ballast used was crushed quartzite obtained from Afrisam Ferro quarry in Pretoria.

The grading of the ballast was done according to TMH 1 Method B4 (1986) and compared to the Transnet specification for heavy haul lines. It can be seen from Figure 2 that the ballast met the specifications for heavy haul lines with a slight deviation from the maximum grading specification for the ballast aggregate passing the 19.0 mm sieve.

Table 1 depicts the material properties of the ballast with the Transnet specifications (1998). It can be seen that all of the specifications are met with the slight exception of the grading and the LA abrasion.

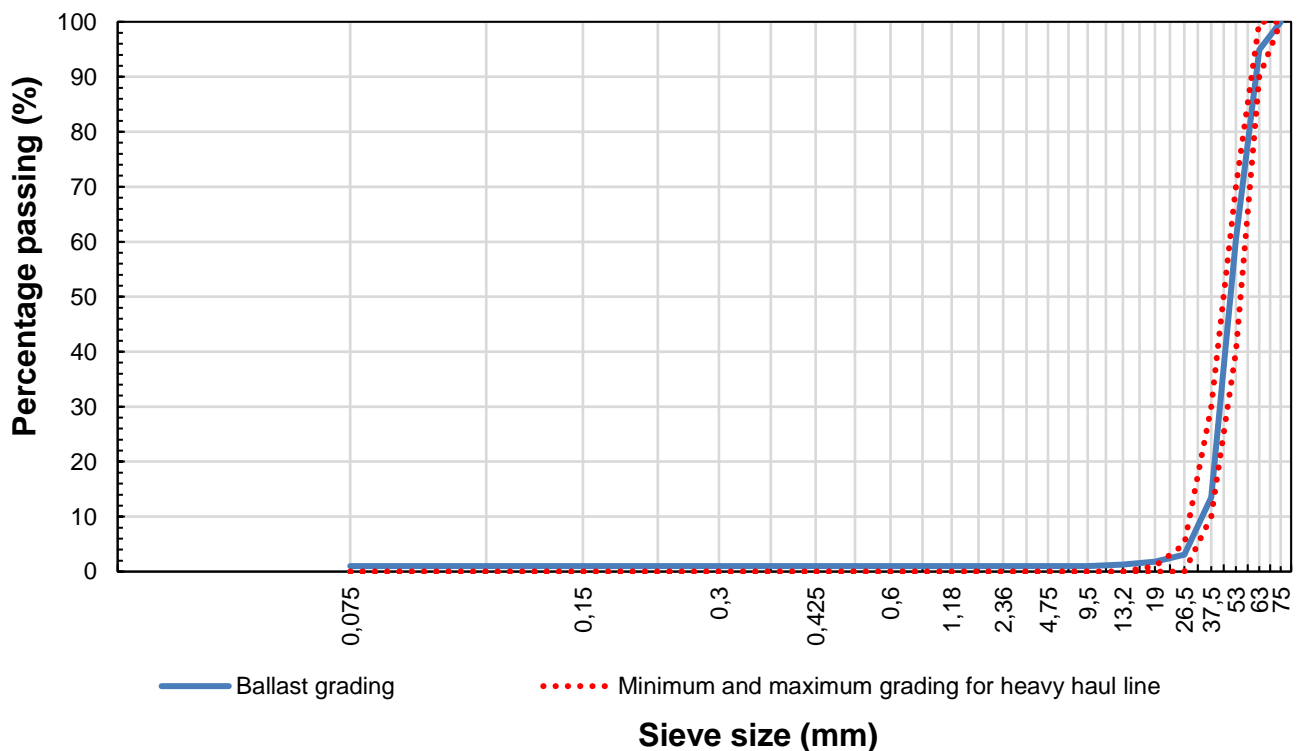

Figure 2: Ballast grading compared to Transnet specifications (1998) for heavy haul lines

Table 1: Material physical properties of ballast with Transnet specifications (1998)

Parameter	Ballast result	Test method / Equation	Transnet S406 specification (1998)
ACV Dry	21.6	SANS 3001 AG10	None
10% FACT Dry (kN)	181		None
Flakiness Index (%)	8.1	SABS 1083	≤ 30 %
LA Abrasion (%)	23.0	ASTM C131	≤ 22 %
Mill Abrasion (%)	5.7	Transnet S406	≤ 7 %
Soundness (%)	4.3	ASTM C88	≤ 5 %
Percentage voids	43.8	SABS 1083	≥ 40 %
Void ratio	0.78	$\frac{\text{Bulk relative density} * 998}{\text{Bulk density}} - 1$	-
Relative density	2.632	SANS 3001 AG20	≥ 2.5
ACV: Aggregate crushing value, FACT: Fines aggregate crushing test, LA: Los Angeles			

3.1.2 Fouling Material

Coal dust was obtained from the Anglo-American Coal plant in Sasolburg to simulate the fouling material and spillages during freight transportation. There were no standards for comparison of the fouling material, but the data may be used for further research. Table 2 depicts the material properties of the coal dust.

Table 2: Coal dust material properties

Parameter	Test Method / Equation	Coal Dust Result
Bulk density (kg/m ³)	TMH 1 Method B9	770
Bulk relative density	SANS 3001 AG21	1.83
Void content (%)	ASTM C1252	57.8
Void ratio	$\frac{\text{Bulk relative density} * 998}{\text{Bulk density}} - 1$	1.37

An analysis of the coal dust was done using a Scanning Electron Microscope (SEM) and an Energy Dispersive X-ray Spectroscopy (EDS) to characterize the morphology of the material. The SEM images are depicted in Figures 3a to 3d. Figure 3a shows a variety of shapes including equant, irregular and discoidal. The particles are of medium sphericity between angular and round. Figure 3d depicts a highly textured surface of an ellipsoidal particle.

An EDS analysis showed the distribution of elements on the particles. The individual layers show that carbon, oxygen, silicon and aluminium are the predominant elements in decreasing order. Iron calcium, potassium, sulphur, magnesium and sodium were also detected but in lower quantities.

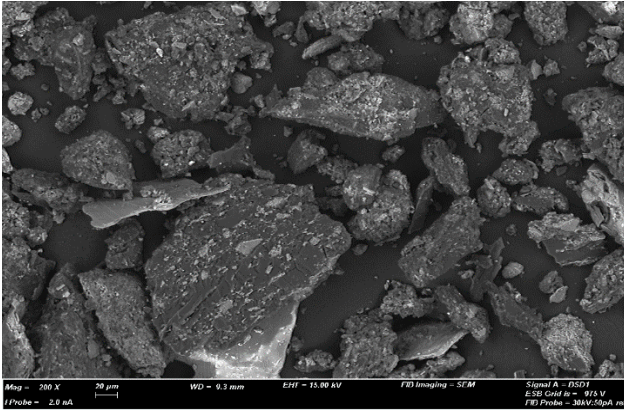

Figure 3a: SEM of Coal: 200x magnified

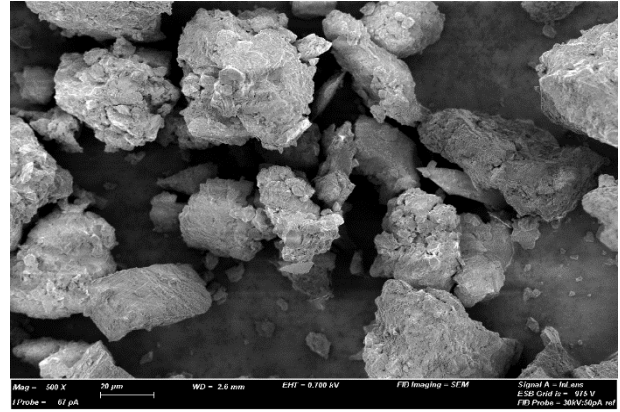

Figure 3b: SEM of Coal: 500x magnified

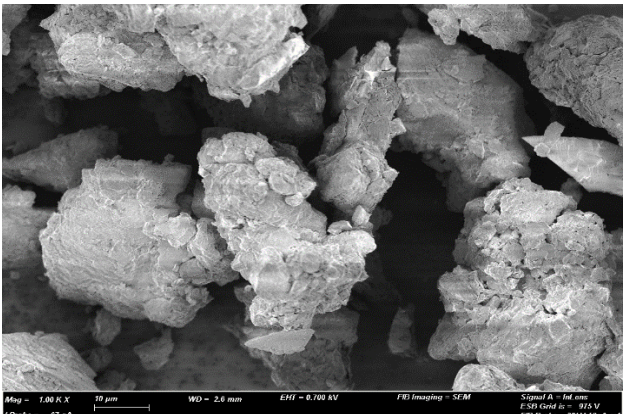

Figure 3c: SEM of Coal: 1 000x magnified

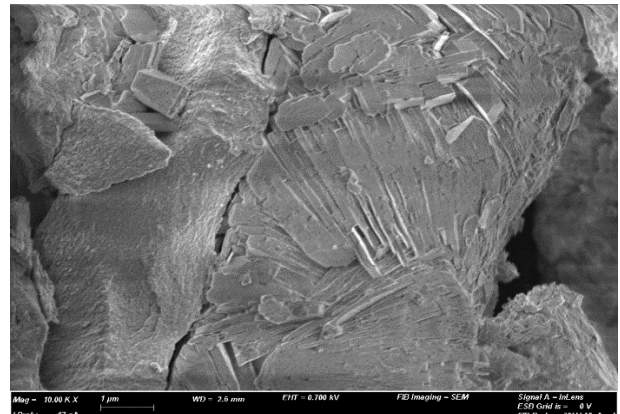

Figure 3d: SEM of Coal: 10 000x magnified

3.2. Sample Preparation

For the box testing, the ballast sample was washed to remove the fines and left to dry. The ballast sample was then quartered using SANS 3001 Method AG1 (2009) to obtain a representative sample. The ballast was then loaded in the box in three layers and compacted using a tamping rod according to AASHTO T 19M/T (2004). After placing the bottom layer, the fouling material (coal dust) was placed above and spread evenly with a moisture content of 5.0 % by weight of fouling material as this would best simulate the first wash of fines at the bottom of the track (see Figure 5).

3.3. Ballast Fouling

The Percentage Void Contamination (PVC) is the ratio of the bulk volume of the fouling material to the initial voids volume of the clean ballast. Feldman and Nissen (2002) identified that the ratio of bulk volume of fouling material needs to be calculated after compacting the fouling and does not accurately represent the track conditions. The Fouling Index (FI) is the summation of percentage (by weight) passing the 4.75 mm and 0.075 mm sieves. This parameter lead to misinterpretation of the actual degree of fouling if materials with significantly different specific gravities were used.

The Void Contamination Index (VCI) as depicted in Equation 1 (Indraratna et al., 2010) was hence used to quantify the degree of fouling.

$$VCI = \frac{1+e_f}{e_b} \times \frac{G_{sb}}{G_{sf}} \times \frac{M_f}{M_b} \times 100 \quad (1)$$

Where,

- e_b = Void ratio of clean ballast
- e_f = Void ratio of fouling material
- G_{sb} = Specific gravity of clean ballast
- G_{sf} = Specific gravity of fouling material
- M_b = Dry mass of clean ballast
- M_f = Dry mass of fouling material

3.4. Performance Testing

The box testing was done using a 500 x 500 x 200 mm metal box following material characterization. The test involved the use of an MTS® hydraulic actuator which applies a continuous cyclic load with no rest period to the ballast sample. A concrete block with an under sleeper pad was used to evenly distribute the load and prevent point contact. It was found that the under sleeper pad contributes to a reduction in ballast breakdown and settlement (Gräbe et al., 2016). The MTS machine has a piston with a loading plate which pushes down onto the concrete block. A cyclic load is then applied where the LVDT sensors measure the vertical displacement.

A vertical load of 6 kN at 10 Hz for 10 000 cycles was used for initial settlement of all the ballast samples. Testing continued with a load 13 kN at 10 Hz for 100 000 cycles. These conditions simulate a 26 tonne axle on the ballast (based on the axle load on a typical heavy-haul line in South Africa). Initial testing at 20 Hz showed excessive vibrations. The final testing was hence conducted at 10 Hz (which showed vibrations that were not enough to displace the ballast substantially). Sample irregularities at the beginning of the box test were removed (initial settlement).

Figure 4 depicts a representation of a typical concrete sleeper used on heavy haul railway lines (Joubert, 2017). The concrete block used above the ballast measured 200 x 150 x 150 mm and Figure 5 depicts a schematic diagram of the MTS® hydraulic actuator and box test setup.

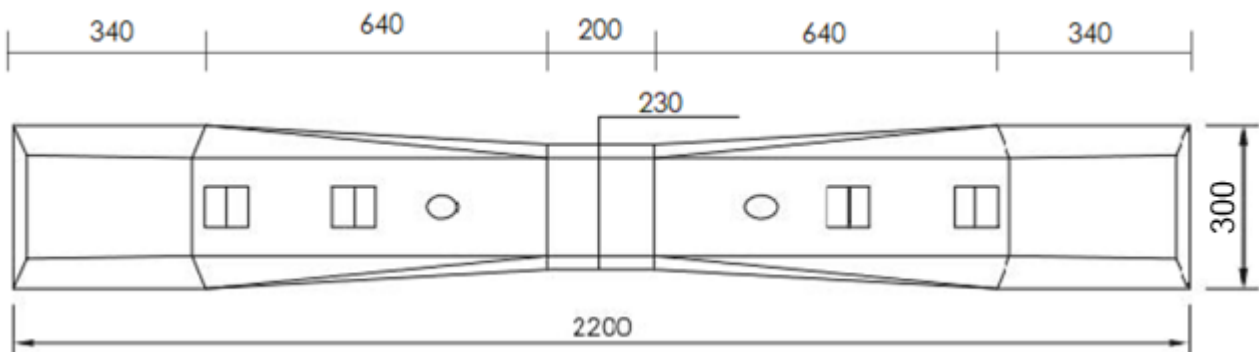

Figure 4: Image of a typical concrete sleeper used on heavy haul railway lines (Joubert, 2017)

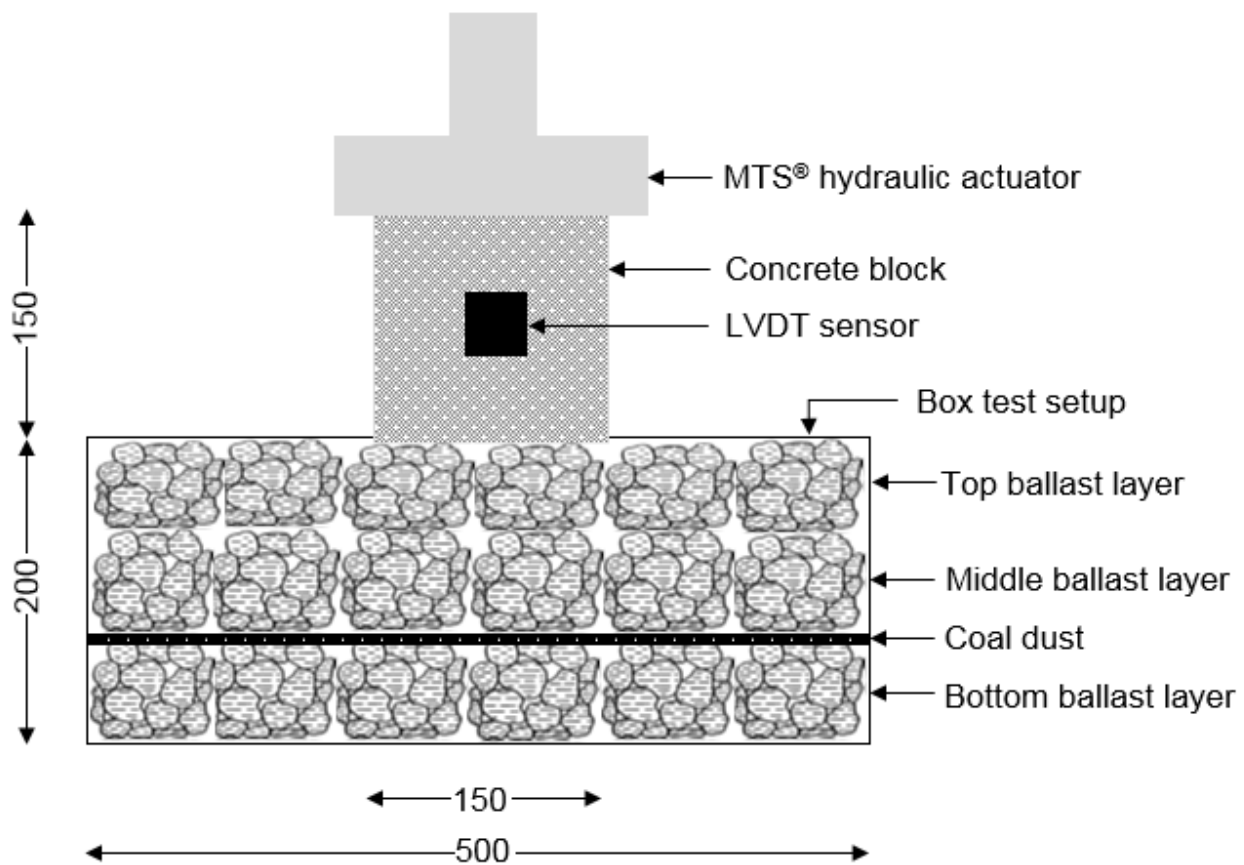

Figure 5: Ballast box test schematic diagram (Civil Engineering laboratory, University of Pretoria)

4 BALLAST SETTLEMENT RESULTS

Large scale box tests were carried out to quantify the effect of fouling material (coal dust) inclusion on rate of settlement of ballast. Initial compaction was done for all ballast samples to settle and condition the ballast before the final testing. The frequency depicts the occurrence of the loading oscillation and the sampling of the machine represents how often the data was retrieved. Table 3 represents the structure of the compaction and final testing.

Table 3: Ballast settlement compaction and final testing structure

	Compaction	Final Testing
Number of cycles	10 000	100 000
Load applied (kN)	6	13
Frequency (Hz)		10
Sampling (Hz)		100

Figure 6 depicts the box testing of fouled ballast at varying void contamination indices (0 [benchmark], 8.4, 16.9, 25.3 and 33.8 %). The thick bands of the graphs are attributed to the cycling loading from the MTS® hydraulic actuator. It can be seen that as the VCI increases, the settlement also increases. The sudden dips in the settlement of all the testing (except the 16.9 % VCI) may be attributed to the breaking of individual ballast particles. The results indicate an increase in settlement of between 11.7 and 40.2 % VCI per 10 % increase in coal contamination.

The data was analysed using the constant rate (gradient) of settlement where there are no sudden dips. Table 4 depicts the rate of ballast settlement and possible breakage points.

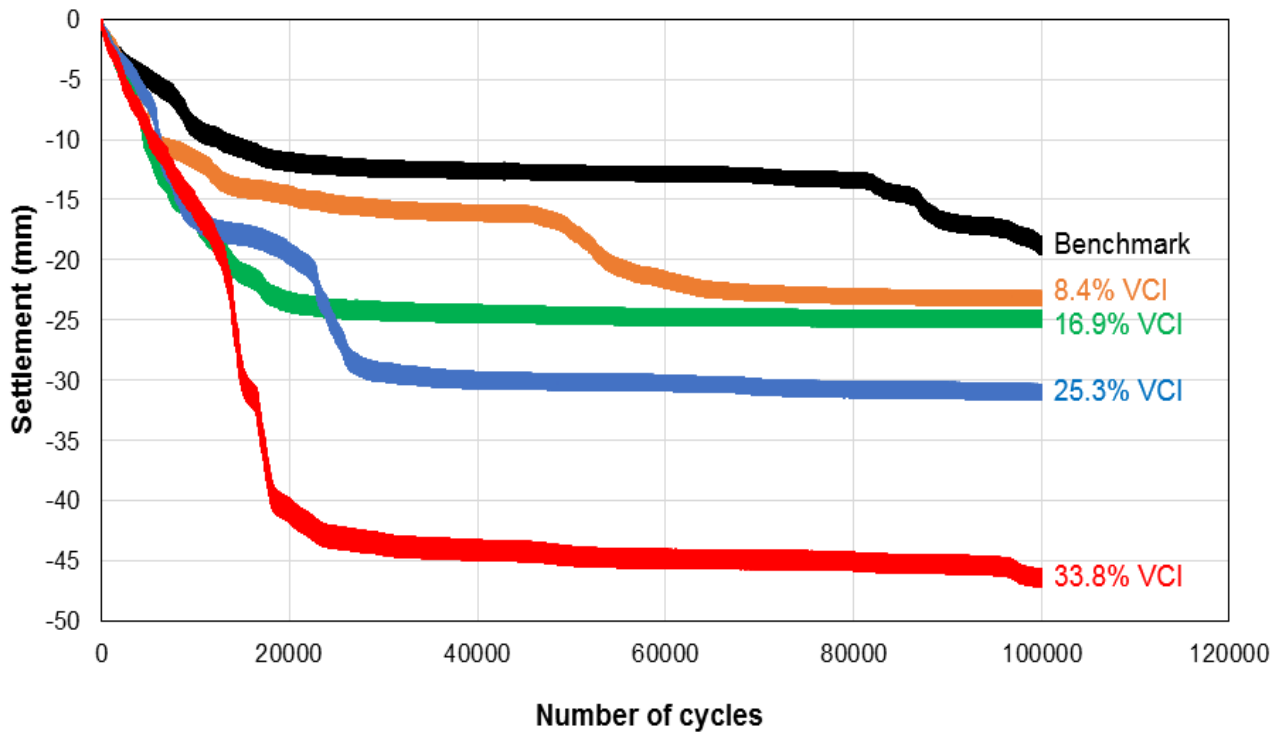

Figure 6: Box test settlement of fouled ballast

Table 4: Rate of ballast settlement and breakage points

VCI (%)	Gradient of settlement		Possible ballast breakage occurrence (at cycles)
	1 mm settlement per x number of cycles	Observed between cycles	
0	40 000	20 000 and 80 000	≈ 8 000 and 88 000
8.4	20 000	60 000 and 100 000	≈ 0 to 8 000 and 48 000
16.9	60 000	20 000 and 80 000	≈ 0 to 10 000 and 22 000
25.3	35 000	30 000 and 100 000	≈ 0 to 18 000
33.8	30 000	20 000 and 90 000	≈ 0 to 18 000

Figure 7 depicts the total settlement per VCI. Current practice does not state the total settlement in which maintenance is to be done. The VCI limit is the point at which no further settlement would occur with an increase in contamination. The limit cannot be observed and it may be necessary to increase the degree on contamination. The possible ballast breakages are part of the analysis and form part of a function for the final settlement. A polynomial trend line to the third degree is depicted in Equation 2 for the total settlement (T_{TD}) per VCI at 100 000 cycles. There is a very good correlation of the data with $R^2 = 0.99$.

$$T_{TD} = -0.0016VCI^3 + 0.0569VCI^2 - 0.8592VCI - 18.924 \quad (2)$$

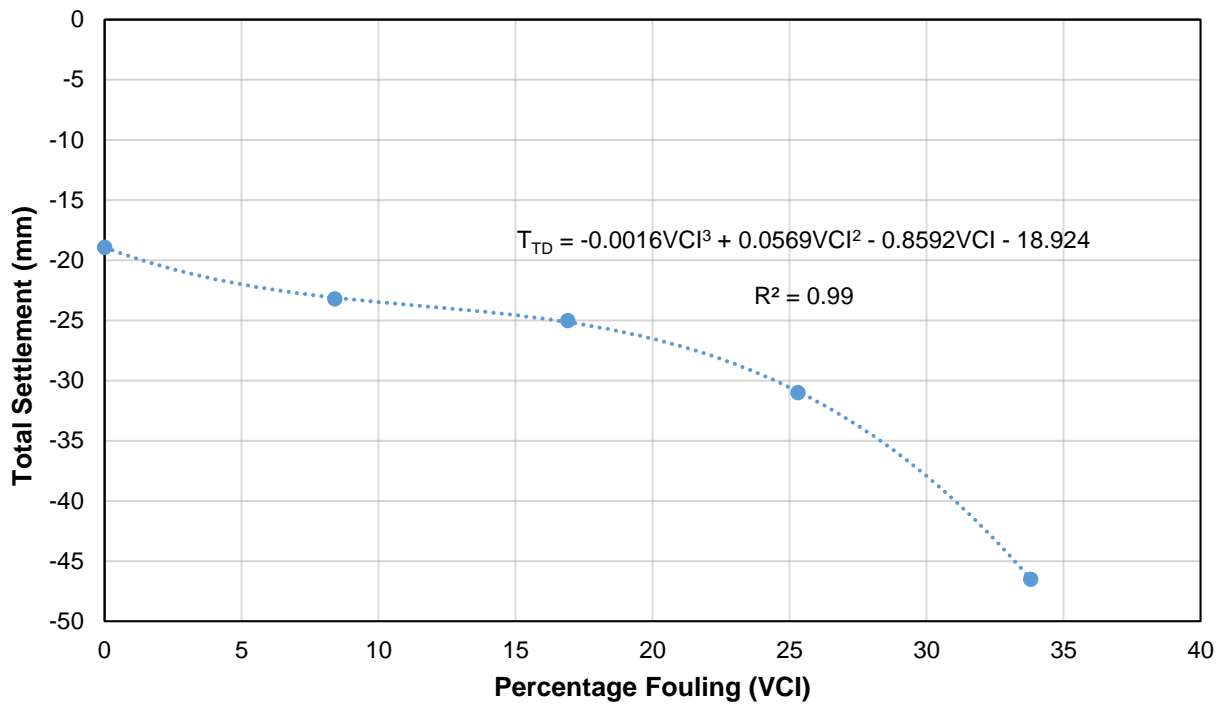

Figure 7: Total settlement per VCI of fouling

6 CONCLUSIONS

The material characterization and the response of fouled ballast in terms of settlement has been quantified in this study. It is noted that there has been no previously published results relating ballast fouling to track settlement in a South African context. The material used (ballast) was quartzite aggregate, characterized to Transnet S406 (1998) and coal dust as fouling material for reference. The following conclusions can be drawn based on the study:

- The influence of fouled ballast does have a significant effect on track settlement - an increase in ballast fouling will result in an increase in track settlement.
- Results indicated an increase in settlement of between 11.7 and 40.2% per 10% increase in coal contamination for a VCI up to 33.8%. The results are based on ballast samples with 5.0% moisture content.
- The study does not generalize track settlement for all aggregates and fouling materials but focusses only on quartzite and coal dust respectively.
- The results of the study pertain to only specific materials and gradings, as well as to specific test conditions that have been applied.

7 RECOMMENDATIONS

The study has confirmed that for quartzite ballast fouled with coal dust, the track does settle with an increase in fouling content. The study is a work-in-progress and it is recommended that further research is done to address the following:

- The use of alternate ballast and fouling materials to broaden the scope.
- The use of varying moisture contents.
- To incorporate track instability limits to determine the VCI in which maintenance is to be done

The above-mentioned recommendations form an integral part to determine limits for track maintenance.

ACKNOWLEDGEMENTS

The authors would like to acknowledge the CSIR for the funding of the study as well as the Advanced Materials Laboratory staff for material testing. The authors would also like to acknowledge the University of Pretoria for using the MTS machine as well as Mr James Joubert, a final year student of the University of Pretoria, for testing of the ballast material.

REFERENCES

AASHTO T 19. 2004. Standard test method for Bulk Density and Voids in Aggregates. AASHTO, USA.

Anbazhagan P, Bharatha T. P and Amarajeevi, G (2012). Study of Ballast Fouling in Railway Track Formations. *Indian Geotech J* (April–June 2012) 42(2):87–99.

Dombrow, W., Huang, H, and Tutumluer, E. 2009. Comparison of coal dust fouled railroad ballast behaviour – Granite vs. limestone. *Proceedings of the 8th International Conference on the Bearing Capacity of Roads, Railways and Airfields 2* (2009) pp. 1349-1357.

Feldman, F. and Nissen, D. 2002. Alternative Testing Method for the Measurement of Ballast Fouling: Percentage Void Contamination. *Conference on Railway Engineering, Wollongong, RTSA*. 101-109.

Gräbe, P.J., Mtshotana, B.F., Sebati, M.M and Thünemann, E.Q. 2016. The effects of under-sleeper pads on sleeper–ballast interaction. *Journal of the South African Institute of Civil Engineering*. Article 1241.

Han, X. and Selig, T. 1997. Effects of fouling on ballast settlement. *6th International Heavy Haul Conference*. April, 1997. South Africa. Vol. 1. pp. 257 – 268.

Huang, H., Tutumluer, E. & Dombrow, W., 2009. Laboratory Characterisation of Fouled Railroad Ballast Behaviour. *Transportation Research Record*, 2117(12), pp. 93-101.

Indraratna, B., Ngo, N. T., and Rujikiatkamjoprn, C. 2011. Behaviour of Geogrid-reinforced ballast under various levels of fouling. *Geotextiles and Geomembranes* 29 (2011) pp. 313-322.

Indraratna, B, Nimbalkar, S and Tennakoon, N. C. 2010. The behaviour of ballasted track foundations: Track drainage and geosynthetic reinforcement, In Fratta, D, Puppala, A & Muhunthan, B (eds), *GeoFlorida 2010: Advances in Analysis, Modeling & Design* (GSP 199), 2010, 2378-2387, USA: ASCE.

Joubert, J. P. 2017. The effects of fouling on the deflection of ballast. Research project report. University of Pretoria, Department of Civil Engineering.

Kashani, H. F., Hyslip, J. P., and Ho, C. L. 2017. Laboratory evaluation of railroad ballast behaviour under heavy axle load and high traffic conditions. *Transportation Geotechnics* 11 (2017) pp. 69-81.

Qian, Y., Tutumluer, E., Hashash, Y.M.A. & Ghaboussi, J., 2014. Effects of Ballast Degradation on Permanent Deformation Behaviour from Large-Scale Triaxial Tests. In *Joint Rail Conference*. Colorado Springs, USA, 2014.

Selig, E. T. and Waters, J. M. 1994. Track Geotechnology and Substructure Management. Thomas Telford, London.

Tennakoon, N., Indraratna, B., Rujikiatkamjorn, C., Nimbalkar, S and Neville, T. 2012. The role of ballast fouling characteristics on the drainage capacity of railway substructure. Geotechnical Testing Journal, 35 (4), 1 – 4.

SANS. 2015. SANS 3001 AG10 - The determination of the Aggregate Crushing Value. Pretoria, South Africa

TMH 1. 1986. Method B4 – The sieve analysis of aggregates, including the determination of the material passing the 0.425 and 0.075 mm sieve. CSIR, Pretoria. South Africa.

Transnet. 1998. S406: Specification for the supply of stone.

Transnet. 2017. Our seven year strategy. Webpage: www.transnetfreightrail-tfr.net. Date Retrieved: 10/11/2017.

Transnet. 2017. Planning: Ballast Screening and Tamping – Coal Line. Transnet Freight Rail.

Wenty, R. 2017. Ballast Maintenance. International Heavy Haul Association. South Africa.